

THOMSON

 **Google TV**



tv.mythomson.com



[tv.mythomson.com/
en/Support/FAQs/](https://tv.mythomson.com/en/Support/FAQs/)



[tv.mythomson.com/
Support/Product-Registration/](https://tv.mythomson.com/Support/Product-Registration/)

SMART TV

55OG8S24 / 65OG8S24 / 77OG8S24

IMPORTANT

Please read this manual carefully before installing and operating the TV.

Keep this manual handy for further reference.

Contents

1	Safety Information	6
1.1	Markings on the product.....	7
1.2	Warning.....	7
1.3	Wall mounting warnings.....	8
1.4	Simplified EU declaration of conformity.....	8
1.5	Apps and performance.....	8
1.6	Data protection	9
2	Introduction and stand installation	9
2.1	Unpacking and installation	10
3.1	Multifunctional navigation button.....	12
3.2	Far-Field Microphone Switch.....	12
3.3	Connections.....	13
4	Remote Control.....	15
5	TV installation	16
5.1	Set your TV.....	16
5.2	Connect antenna and power.....	16
6	Initial setup	17
6.1	Pairing Bluetooth remote	17
6.2	Language selection.....	17
6.3	Region or country selection.....	18
6.4	TV setup option.....	18
6.4.1	Set up Google TV.....	19
6.4.2	Set up basic TV.....	26
7	Tuner Mode.....	27
7.1	Antenna.....	27

7.2	Cable.....	27
7.3	Satellite.....	28
8	Home Screen.....	31
8.1	Google Account	32
8.2	Apps.....	32
8.3	Library	33
8.4	Google TV Search.....	34
8.5	Notifications	35
9	Settings.....	35
9.1	Set your device name.....	36
9.2	Channels and inputs.....	36
9.2.1	Channels.....	36
9.2.2	Inputs	39
9.3	Display and Sound	40
9.3.1	Picture	40
9.3.2	Sound	44
9.3.3	Audio Output	46
9.4	Network & Internet.....	46
9.4.1	Wi-Fi On/Off.....	46
9.4.2	Choose available Wi-Fi Network.....	46
9.4.3	Other options.....	47
9.4.4	Ethernet options.....	47
9.4.5	Others	47
9.5	Accounts & Profiles	48
9.6	Privacy.....	48
9.7	Apps.....	49
9.8	System.....	51
9.8.1	Accessibility.....	51
9.8.2	About.....	51
9.8.3	Date and Time.....	52
9.8.4	Language	52
9.8.5	Keyboard.....	52

9.8.6	Storage	52
9.8.7	Ambient mode.....	52
9.8.8	Power and Energy.....	53
9.8.9	Cast	53
9.8.10	Google	54
9.8.11	System sounds.....	54
9.8.12	Shop Mode	54
9.8.13	Restart.....	54
9.9	Remote and accessories.....	54
9.10	Help & Feedback	55
10	Source & Shortcuts & Recent direct access Menu	55
11	Multimedia Player.....	58
12	Live TV Settings.....	59
13	Live TV App.....	60
13.1	Channels Menu.....	61
13.1.1	Programme Guide (EPG).....	61
13.1.2	Channel.....	62
13.1.3	Channel Management	62
13.1.4	Channel List options.....	65
13.2	TV Options	68
13.2.1	Source	68
13.2.2	Picture	68
13.2.3	Screen	69
13.2.4	Sound	69
13.2.5	Power.....	69
13.2.6	Parental controls.....	69
13.2.7	CI Card	69
13.2.8	Advanced Options.....	69
13.2.9	Settings.....	70
13.3	Record.....	70
13.3.1	Start recording.....	71
13.3.2	Record List.....	71

13.3.3	Device Info	71
13.3.4	Schedule List.....	72
13.3.5	Time Shift Mode.....	72
14	Daily Key Button Function.....	73
15	Troubleshooting	77
16	Technical specifications	77
16.1	Country restrictions	78
16.2	Licenses	78

1 Safety Information



In extreme weather (storms, lightning) and long inactivity periods (going on holiday) disconnect the TV set from the mains.

The mains plug is used to disconnect the TV set from the mains and therefore it must remain readily operable. If the TV set is not disconnected electrically from the mains, the device will still draw power for all situations even if the TV is in standby mode or switched off.

Note: Follow the onscreen instructions for operating the related features.

Important: Please read these instructions fully before installing or operating the TV.

WARNING

This device is intended to be used by persons (including children) who are capable / experienced of using such a device unsupervised, unless they have been given supervision or instruction concerning the use of the device by a person responsible for their safety.

- Use this TV set at an altitude of less than 2000 meters above sea level, in dry locations and in regions with moderate or tropical climates.
- The TV set is intended for household and similar general use but may also be used in public places.
- For ventilation purposes, leave at least 10cm of free space around the TV.
- The ventilation should not be impeded by covering or blocking the ventilation openings with items, such as newspapers, tablecloths, curtains, etc.
- The power cord plug should be easily accessible. Do not place the TV, furniture, etc. on the power cord. A damaged power cord/plug can cause fire or give you an electric shock. Handle the power cord by the plug, do not unplug the TV by pulling the power cord. Never touch the power cord/plug with wet hands as this could cause a short circuit or electric shock. Never make a knot in the power cord or tie it with other cords. When damaged it must be replaced, this should only be done by qualified personnel.
- Do not expose the TV to dripping or splashing of liquids and do not place objects filled with liquids, such as vases, cups, etc. on or over the TV (e.g., on shelves above the unit).
- Do not expose the TV to direct sunlight and do not place open flames such as lit candles on the top of or near the TV.
- Do not place any heat sources such as electric heaters, radiators, etc. near the TV set.
- Do not place the TV on the floor or inclined surfaces.
- To avoid danger of suffocation, keep plastic bags out of reach of babies, children and domestic animals.
- Carefully attach the stand to the TV. If the stand is provided with screws, tighten the screws firmly to prevent the TV from tilting. Do not over-tighten the screws and mount the stand rubbers properly.
- Do not dispose of the batteries in fire or with hazardous or flammable materials.

- Do not use household cleaning agents to clean the TV. Instead clean the screen with a soft, dry cloth. Before cleaning, unplug the device for safety.

WARNING

- Batteries must not be exposed to excessive heat such as sunshine, fire or the like.
- Excessive sound pressure from earphones or headphones can cause hearing loss.

ABOVE ALL - NEVER let anyone, especially children, push or hit the screen, push anything into holes, slots or any other openings in the case.

1.1 Markings on the product

The following symbols are used on the product as a marker for restrictions and precautions and safety instructions. Each explanation shall be considered where the product bears related marking only. Note such information for security reasons.



Class II Equipment: This appliance is designed in such a way that it does not require a safety connection to electrical earthing.



This marking indicates that this product should not be disposed with other household wastes throughout the EU. Please recycle it responsibly to promote the sustainable reuse of material resources. To return your used device, please use the return and collection systems or contact the retailer where the product was purchased.

1.2 Warning

Do not ingest the battery, due to Chemical Burn Hazard. This product or the accessories supplied with the product may contain a coin/button cell battery. If the coin/button cell battery is swallowed, it can cause severe internal burns in just 2 hours and can lead to death.

Keep new and used batteries away from children. If the battery compartment does not close securely, stop using the product and keep it away from children.

If you think batteries might have been swallowed or placed inside any part of the body, seek immediate medical attention.

A television may fall, causing serious personal injury or death. Many injuries, particularly to children, can be avoided by taking simple precautions such as:

- ALWAYS use cabinets or stands or mounting methods recommended by the manufacturer of the television set.
- ALWAYS use furniture that can safely support the television set.
- ALWAYS ensure the television set is not overhanging the edge of the supporting furniture.
- ALWAYS educate children about the dangers of climbing on furniture to reach the television set or its controls.

- ALWAYS route cords and cables connected to your television so they cannot be tripped over, pulled or grabbed.
- NEVER place a television set in an unstable location.
- NEVER place the television set on tall furniture (for example, cupboards or bookcases) without anchoring both the furniture and the television set to a suitable support.
- NEVER place the television set on cloth or other materials that may be located between the television set and supporting furniture.
- NEVER place items that might tempt children to climb, such as toys and remote controls, on top of the television or furniture on which the television is placed on.
- The equipment is only suitable for mounting at heights ≤ 2 m.

If the existing television set is going to be retained and relocated, the same considerations as above should be applied.

Apparatus connected to the protective earthing of the building installation through the mains connection or through other apparatus with a connection to protective earthing – and to a television distribution system using coaxial cable, may in some circumstances create a fire hazard. Connection to a television distribution system has therefore to be provided through a device providing electrical isolation below a certain frequency range (galvanic isolator).

1.3 Wall mounting warnings

- Read the instructions before mounting your TV on the wall.
- The wall mount kit is optional. You can obtain it from your local dealer if it is not supplied with your TV.
- Do not install the TV on the ceiling or on an inclined wall.
- Use the specified wall mounting screws and other accessories.

Tighten the wall mounting screws firmly to prevent the TV from falling. Do not overtighten the screws.

Figures and illustrations in this user manual are provided for reference only and may differ from the actual product appearance. Product design and specifications may be changed without notice.

1.4 Simplified EU declaration of conformity

Hereby, StreamView GmbH declares that the radio equipment type product device Smart TV is complying with Directive 2014/53/EU.

1.5 Apps and performance

Download speed depends on your Internet connection. Some apps might not be available in your country or region. Netflix is available in selected countries:

<https://help.netflix.com/node/14164> Streaming membership is required. More information at www.netflix.com. The availability of the language for Google Assistant depends on Google Voice Search support.

1.6 Data protection

The application providers and the providers of the services may collect and use technical data and related information, including but not limited to technical information about this device, system and application software and peripherals. They may use such information to improve products or to provide services or technologies which do not personally identify you.

Additionally, some third-party services, already provided in the device or installed by you after purchasing the product, may request a registration with your personal data. Some services may collect personal data without providing additional warnings. StreamView GmbH cannot be held liable for a possible breach of data protection by third-party services.

2 Introduction and stand installation

Thank you for choosing our product. You'll soon be enjoying your new TV. Please read these instructions carefully. They contain important information which will help you get the best from your TV and ensure safe and correct installation and operation.

2.1 Unpacking and installation

Take out the feet and the TV from the packing and put the feet onto a table or any other even surface.

- Use a flat and firm table or similar even surface that can support the weight of the TV.
- Do not hold the TV on the screen panel.
- Make sure not to scratch or break the TV.
- The feet are marked left and right.

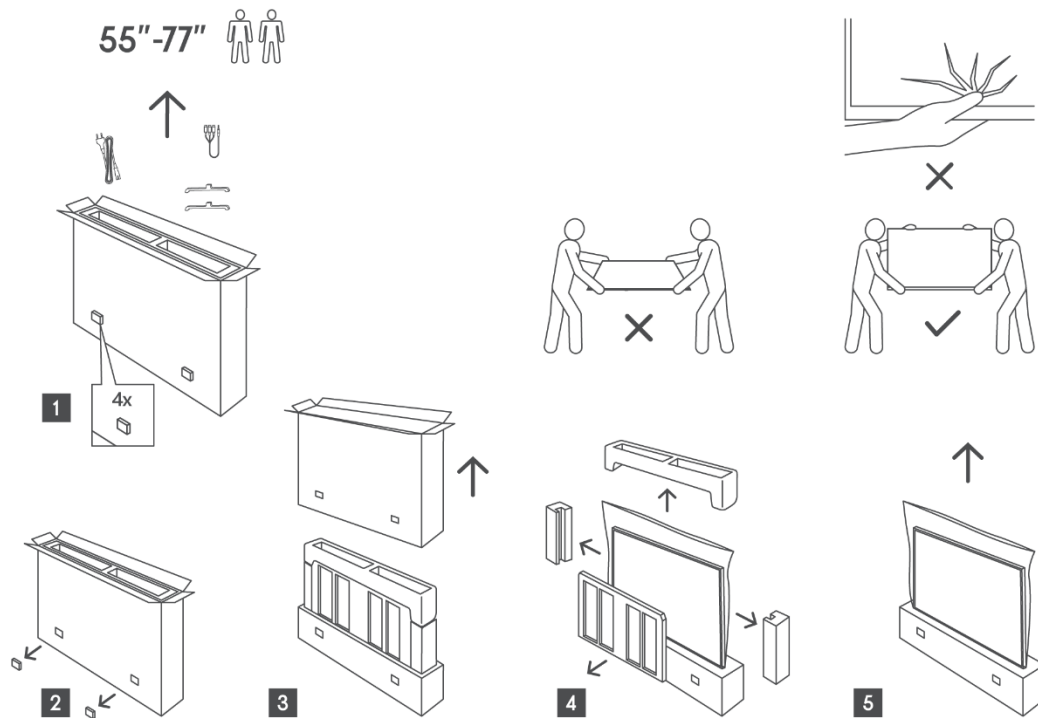

Feet installation

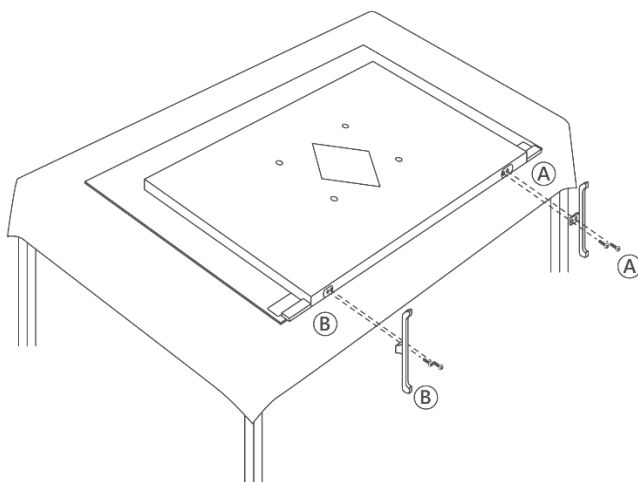

An optional wall mount can be used for your television with a VESA-compliant wall mount bracket. Contact your local dealer to purchase the recommended wall mount bracket.

Note:

- Securely attach the bracket to the rear of the TV and install it on a solid wall perpendicular to the floor. If mounting to other materials, consult qualified personnel. Detailed installation instructions are provided with the wall mount. Ensure the bracket allows enough space for connecting external devices and that the TV is properly secured.
- To prevent damage or injury, ensure the TV screen remains upright or tilted within a 0° to 5° range when mounted.
- If tilting beyond this range is required, purchase auxiliary accessories from your local dealer to ensure safe installation. Failure to do so will void the warranty, and you will be responsible for any resulting issues.
- Disconnect the power before moving or installing the TV to avoid the risk of electric shock.
- Before wall mounting the TV, remove the stand by reversing the stand attachment process.
- Do not install the TV on a ceiling or slanted wall, as it may fall and cause serious injury. Always use an authorized wall mount and consult your local dealer or qualified personnel, as improper installation is not covered by the warranty.
- Avoid over-tightening the screws to prevent damage to the TV and voiding the warranty.
- Ensure the TV is securely attached to the wall according to the installation instructions to prevent injury.
- Use screws and wall mounts that meet the specified requirements. Damages or injuries caused by misuse or improper accessories are not covered by the warranty.

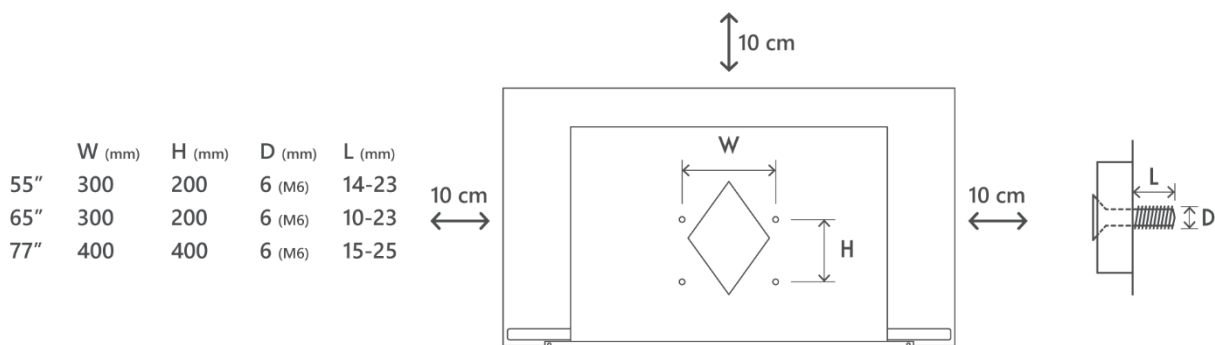

3 Multifunctional navigation button, Far-field microphone switch and TV connections

Caution:



If you want to connect a device to the TV, make sure that both the TV and the device are turned off before making any connection. After the connection is done, you can turn on the units and use them.



Do not touch or be close to the HDMI, USB terminals, and prevent electrostatic discharge to disturb these terminals while in USB operation mode, or it will cause the TV to stop working or cause an abnormal status.

Note:

The actual position and arrangement of ports may be different from model to model.

3.1 Multifunctional navigation button

Press this button to turn the TV on or switch it to standby mode

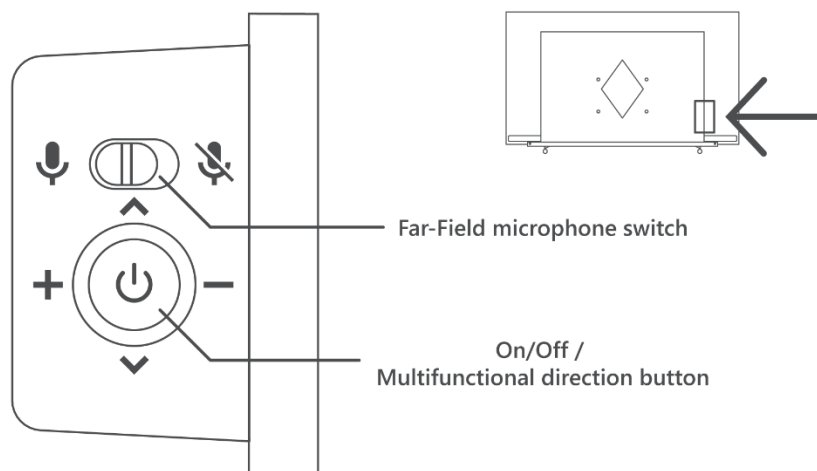

3.2 Far-Field Microphone Switch

Slide this switch to mechanically activate or deactivate the functionality of the built-in far-field microphones.

3.3 Connections

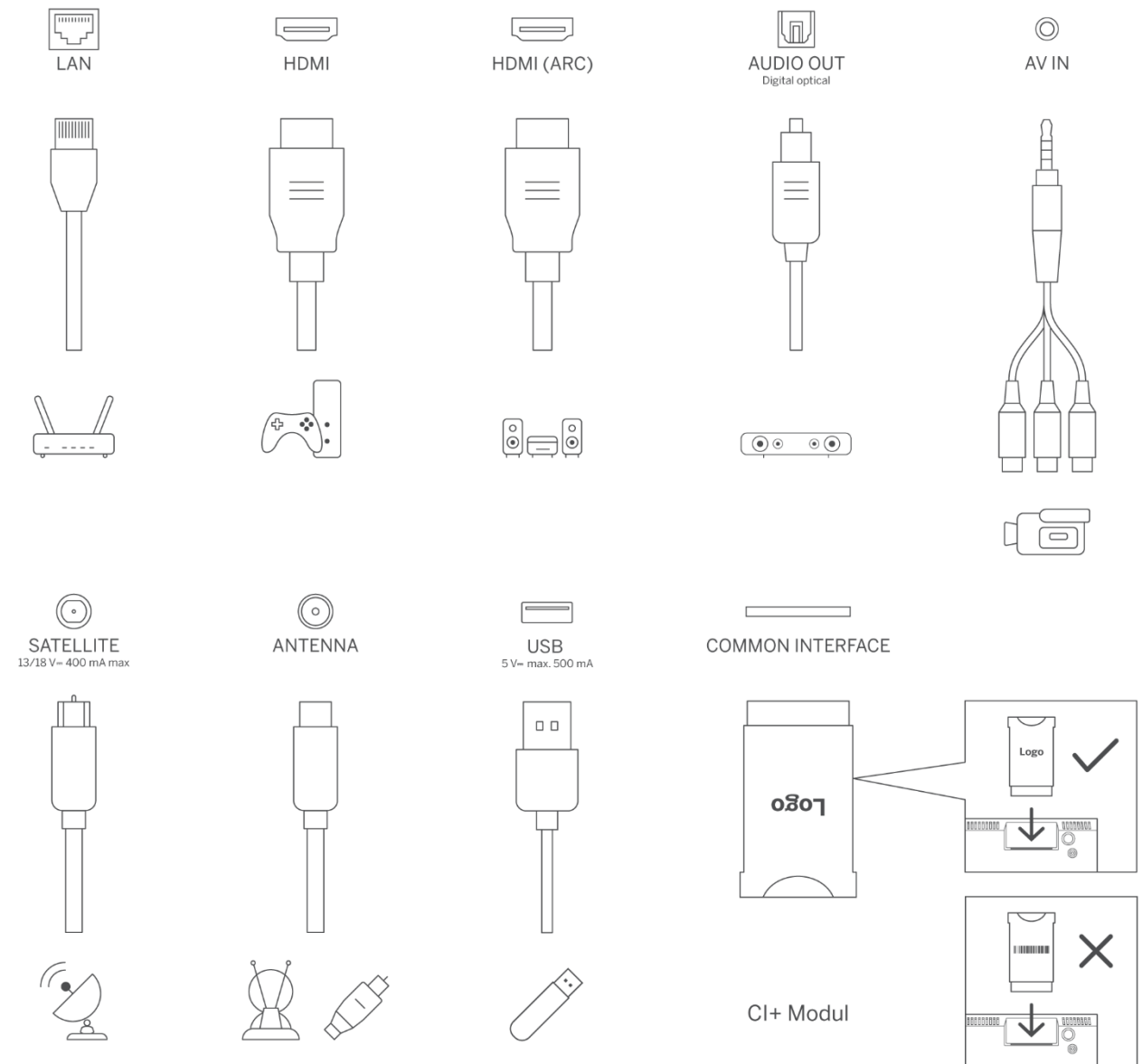



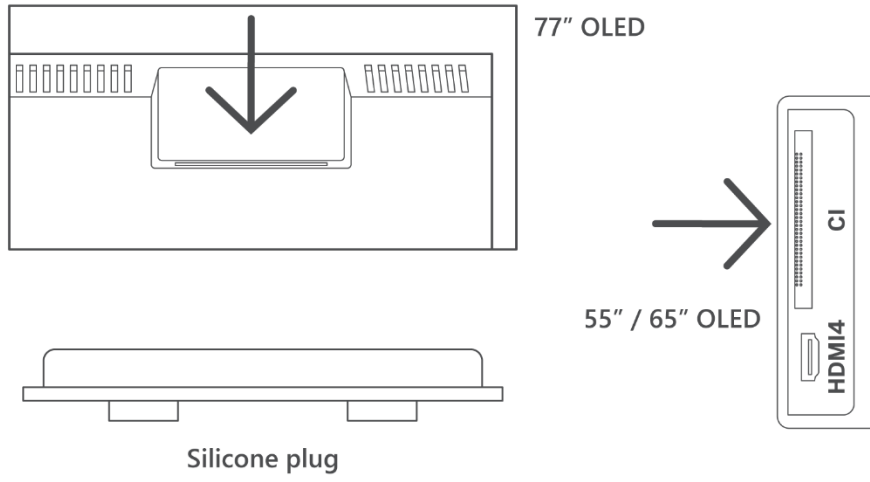



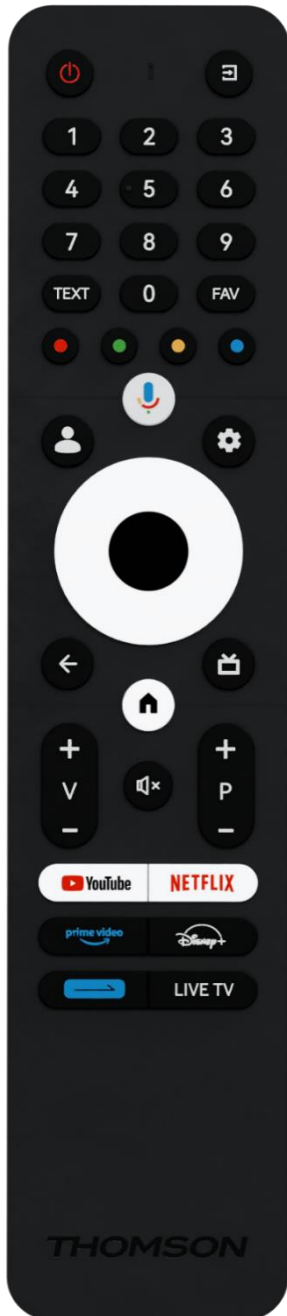









Note: If the model has a CI card slot on the top, a silicone plug for the CI card slot can be found in the accessory bag (for models without CI card slot, there is no such silicone plug), please insert the silicone plug into the slot when the CI card is not in use.



4 Remote Control



	Power button/Standby: Quick Standby / Standby / On
	Source/Input: Select the input of the TV
0-9	Numeric buttons: Switch the channel in Live TV mode, enter a number or a letter in the text box on the screen
TEXT	Open and close teletext (where available in Live TV mode)
SUB	Turn subtitles on and off (where available)
	Colored Buttons: Follow the on-screen instructions for colored button functions
	Microphone: Activate the Google Assistant
	Profile Switch: Switch between multiple Google profiles
	Settings: Display Live TV Settings menu (in Live TV mode), display available setting options such as sound and picture; In case you have purchased a SW with PVR (recording) function: upon pressing and holding setting button for 5 seconds, an additional keyboard with more functions opens in the TV Live app.
	Directional buttons: Navigate menus, setting options, move the focus or cursor etc., set record time and display the subpages in Live TV-Teletext mode when pressed Right or Left. Follow the on-screen instructions
	OK: Confirm selections, enter sub-menus, view channel list (in Live TV mode). Press 5 sec. to switch the backlight of the remote control on/off
	Back/Return: Return to previous menu screen, go one step back, close windows, close teletext (in Live TV-Teletext mode). Exit the playback of multimedia files and return to the MMP (Multi Medi Player) overview menu
	Electronic program guide
	Home: Open the Home Screen
+ v -	Volume +/-: Control the Sound Volume of the TV.
	Mute: Completely turn off the volume of the TV
+ P -	Programs +/-: Switch between TV/radio channels. Scroll the channel list page by page when the channel list is displayed on the TV screen.
	Launch the YouTube application
	Launch the Netflix application
	Launch the Prime Video application
	Launch the Disney + application
	Daily key button. Choose and set your favourite app(s) or function(s) for easier access.
LIVE TV	Launch the Live TV application

5 TV installation

5.1 Set your TV

Put your TV on a firm place which can handle the weight of the TV. To avoid danger, please do not position the TV near water or heat sources (such as light, candle, heater), do not block the ventilation at the back of the TV.

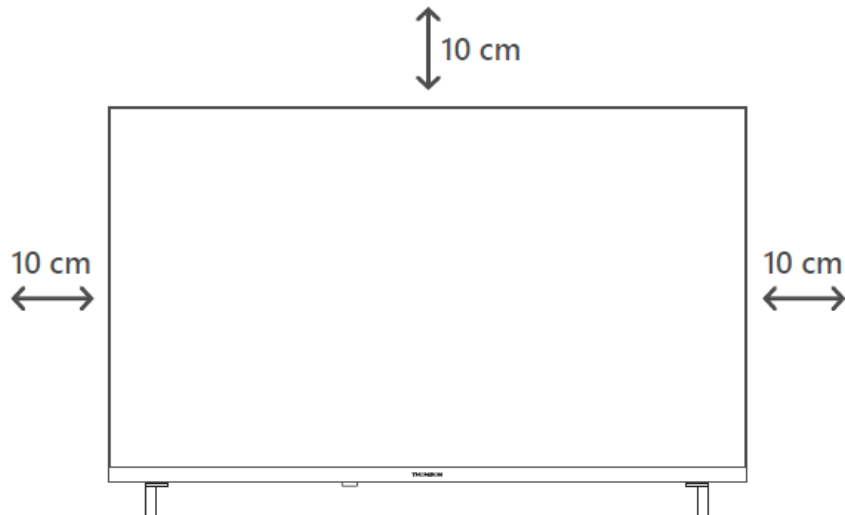

5.2 Connect antenna and power

1. Connect the antenna cable to the antenna socket on the back of the TV.
2. Plug in the power cord of your TV (AC 100-240 V~ 50/60 Hz). The TV enters standby mode (red light).
3. Turn on your TV by pressing the power button of the TV or the power button on the remote control.
4. In case you have purchased a TV model with 12 Volt adapter included - use the right port to connect the adapter to the TV set.

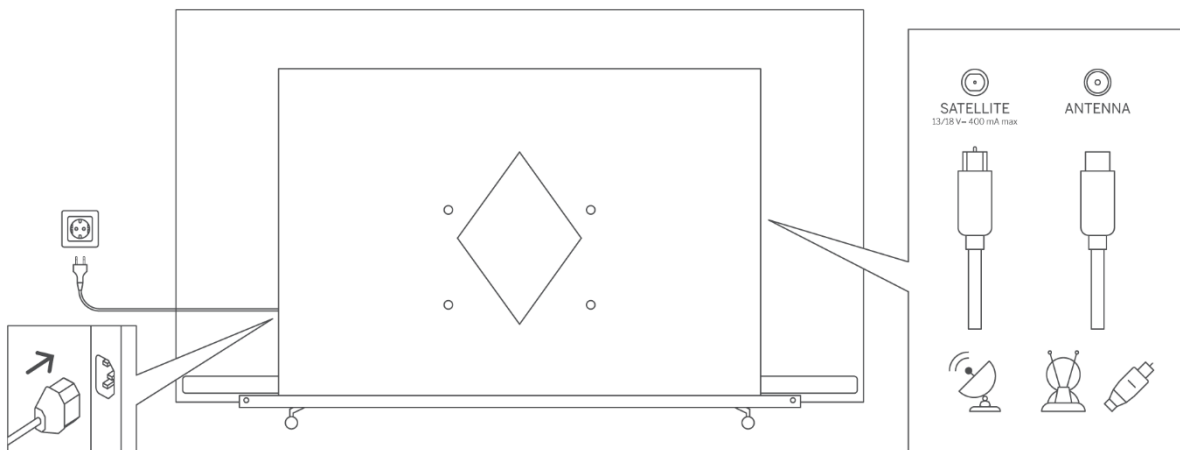

Note:

When you have finished assembling the TV, please remove the transparent protective foil from the front and back of the TV display.

6 Initial setup

For the first initial setup, the on-screen setup wizard will guide you through setting up your TV. Please follow the instructions carefully to setup your TV correctly.

6.1 Pairing Bluetooth remote

Press the Microphone button on your remote control to enter the Bluetooth pairing mode. The indicator light on the remote control will flash when starting the pairing process as well as the corresponding screen will be displayed.



We recommend that you complete the remote-control pairing process. However, if you skip this, you can subsequently pair the remote control with the TV in the Settings > Remote controls & accessories menu.

6.2 Language selection

Use up/down directional buttons to select system language, then press OK to confirm.

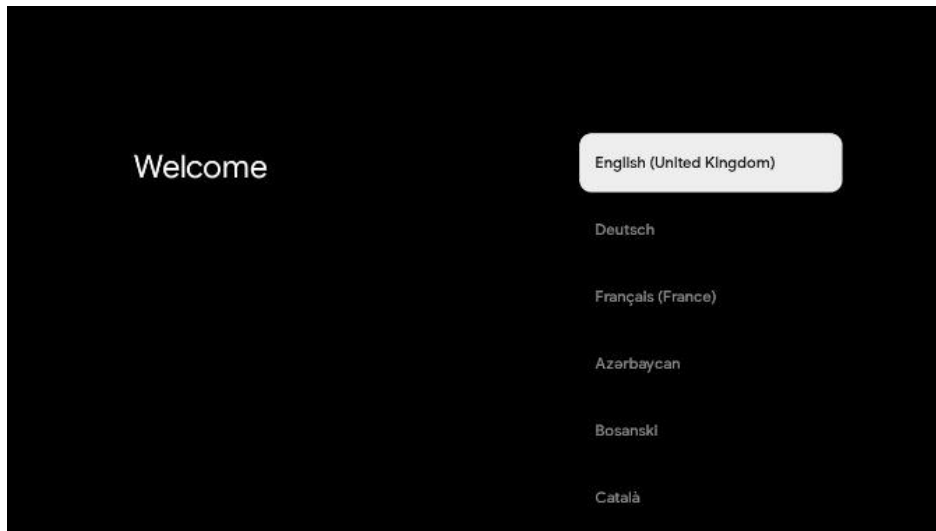

6.3 Region or country selection

Select the country you are located in to perform the installation correctly. This is important because the availability in the Google Play store and installation procedure of many applications depends on the geographic location (Geo-location). This is why certain applications are available for one country and not for others.

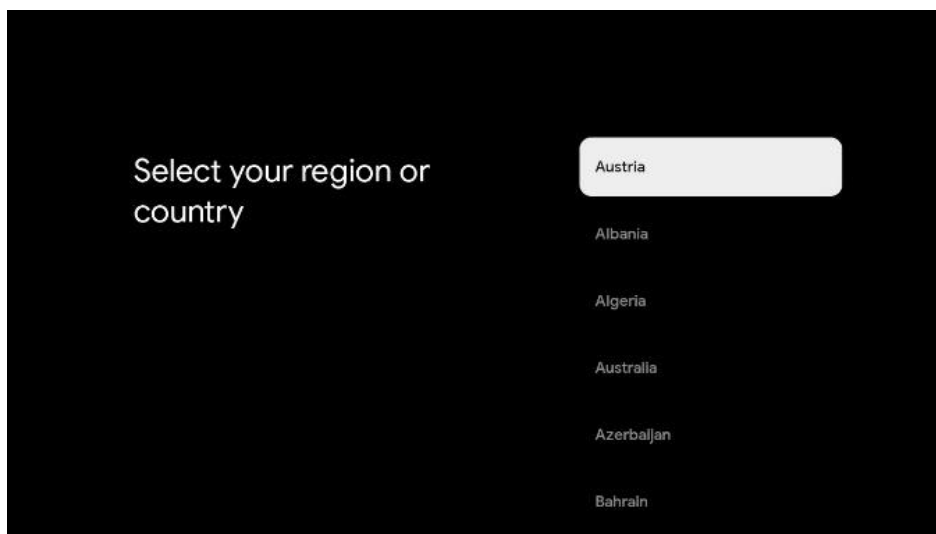

6.4 TV setup option

Use up/down directional buttons to select your TV setup option, then press OK to confirm.

Note: If you select Set up Google TV, you will require a Google account to proceed with the installation. You can use an existing Google account or create a new one.

Note: Please select the Set up Basic TV option if you only want to use your TV to watch TV or listen to radio programs via terrestrial antenna, cable, or satellite antenna and if you do not want

to connect your TV to the internet so that you can watch video contents from streaming Apps like YouTube or Netflix.

The detailed installation of the Basic TV option is described in the menu chapter 6.4.2.

6.4.1 Set up Google TV

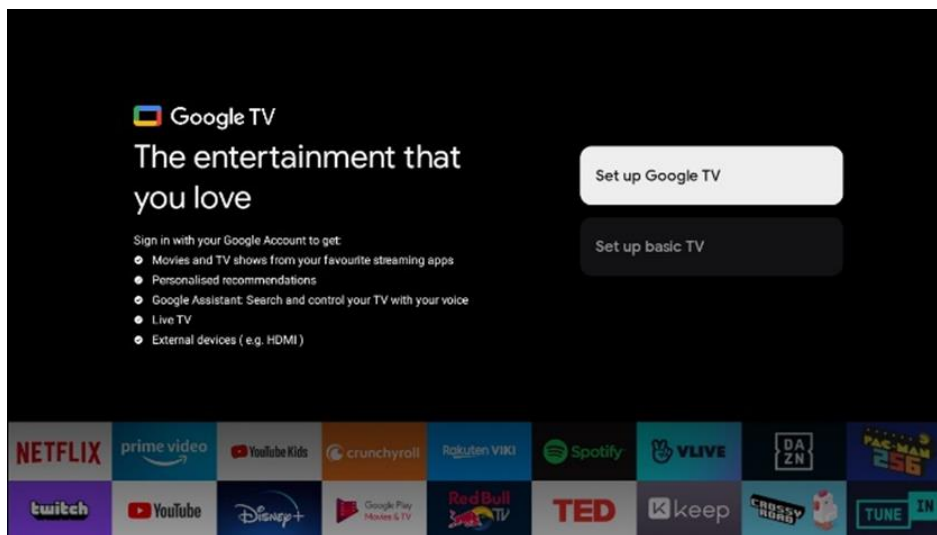

6.4.1.1 Set up with Google Home App

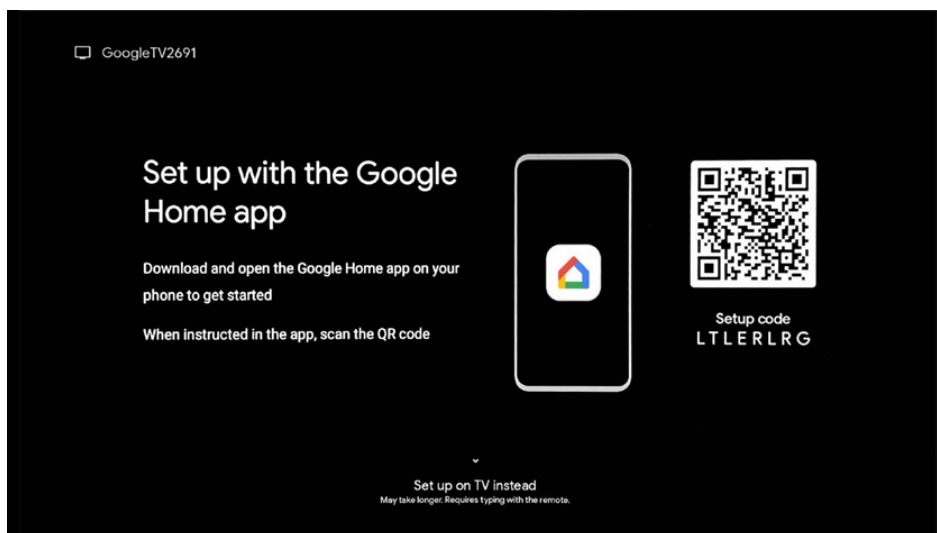

To set up with the Google Home app, it is necessary to have a mobile device (smartphone or tablet) with the Google Home app installed. To install the Google Home app, please scan the QR code on your TV or search for Google Home in the app store on your mobile device. If the Google Home app is already installed on your mobile device, open it and follow the instructions on your TV and mobile device. The setup of the TV via the Google Home application on your mobile device should not be interrupted.

Note: Some mobile devices with the latest Android OS version are not fully compatible with the installation of Google TV via Google Home App. Therefore, we recommend the installation option Set up on TV.

6.4.1.2 Set up on TV

Please select this installation option if you want to set up your TV using the remote control.

6.4.1.3 Select your Wi-Fi Network

To utilize the many advantages of your Google TV, your TV must be connected to the Internet. You can connect your TV to your modem/router wirelessly via Wi-Fi or by cable.

Note:

Your Internet connection is automatically recognized and displayed if you have connected your TV to the modem/router directly using the LAN connection cable.

If you want to connect your TV to the internet wirelessly via Wi-Fi, press the up/down directional buttons to select the desired WLAN network, enter the password and then press Confirm to establish the connection. If you select Skip because you want to set up your TV as a Basic TV, you can configure the internet connection later in the TV Settings menu.

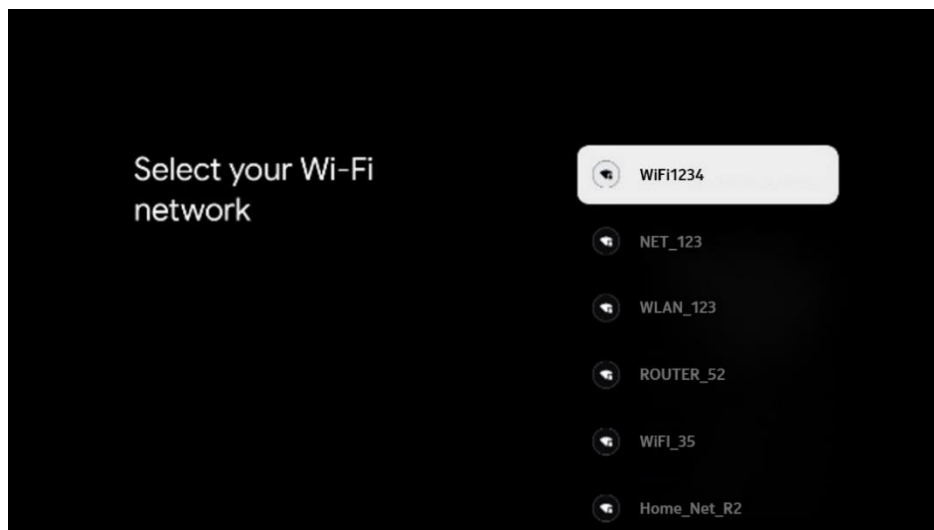

6.4.1.4 Sign-in with your Google Account

To sign in with your Google account, enter your email address and your password.

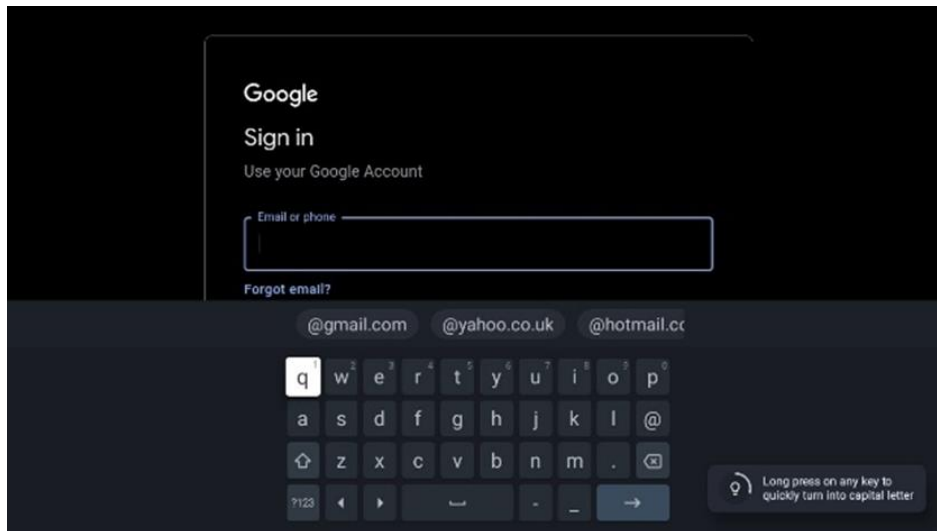

6.4.1.5 Google Terms of Services

Before you continue, please take the time to read the General Terms and Conditions, the Terms of Use for Games, the Privacy Policy, and the available Google services. You declare your agreement with these services by clicking on Accept.

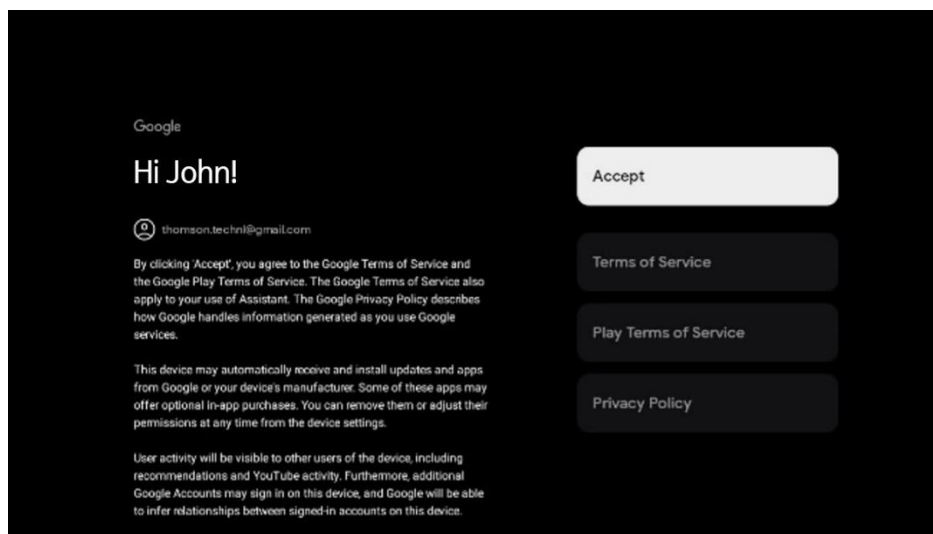

Select Accept to confirm if you want your location identified on your Google Privacy Policy and agree to automatically send diagnostic information to Google to help improve your Google experience.

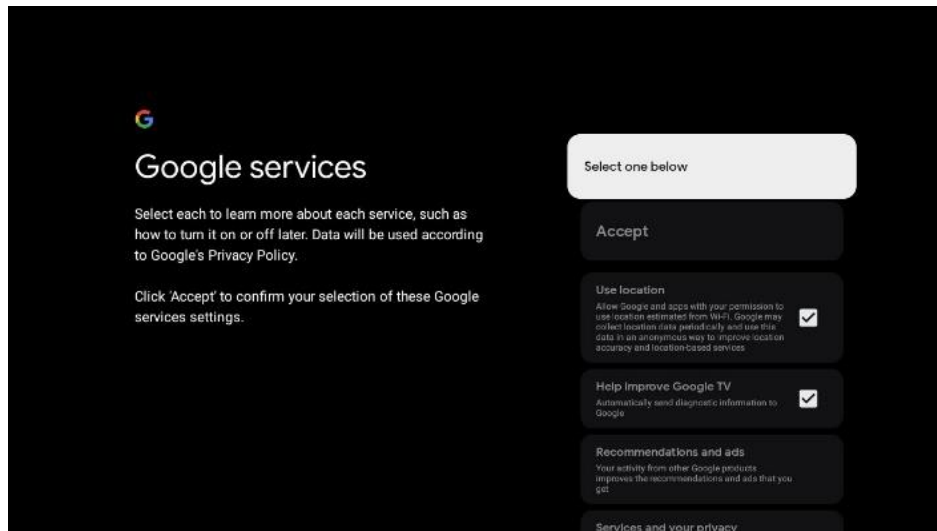

6.4.1.6 Confirm or reject Google services and features

Carefully read through the services and functions that your TV offers. If you don't want to activate one or more of the offered services, you can reject them by clicking No, thanks.

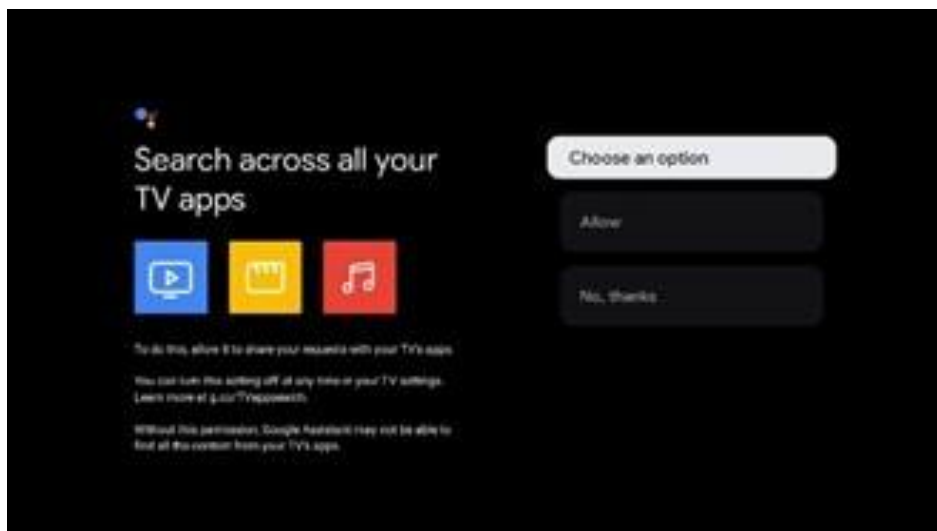

6.4.1.7 Choose your subscriptions

In this step you can select which streaming applications you would like to install automatically. These might be applications for which you already have a subscription for, or applications suggested to you by Google.

Some applications are already pre-selected. You can deselect them, which means that they won't be automatically installed during the first set-up process.

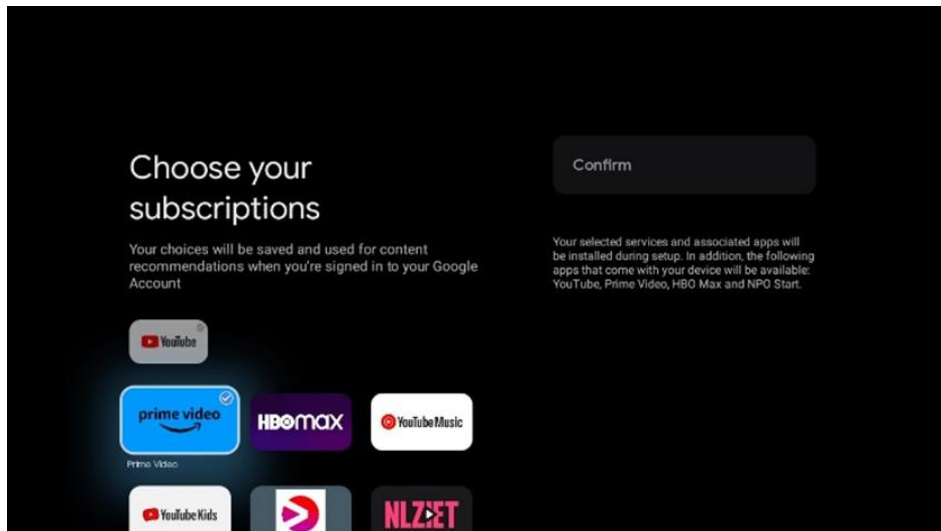

6.4.1.8 End User License Agreement

This agreement mainly declares items regarding software usage specifications, responsibilities of third parties, legal statements, privacy policy, Limitation of liability and so on.

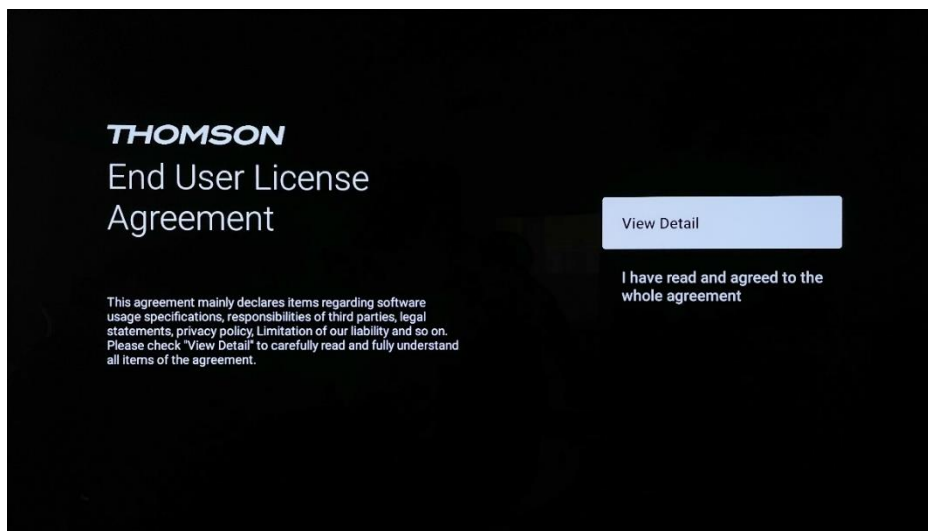

Please check "View Detail" to carefully read and fully understand all items of the agreement.

6.4.1.9 LCN Switch

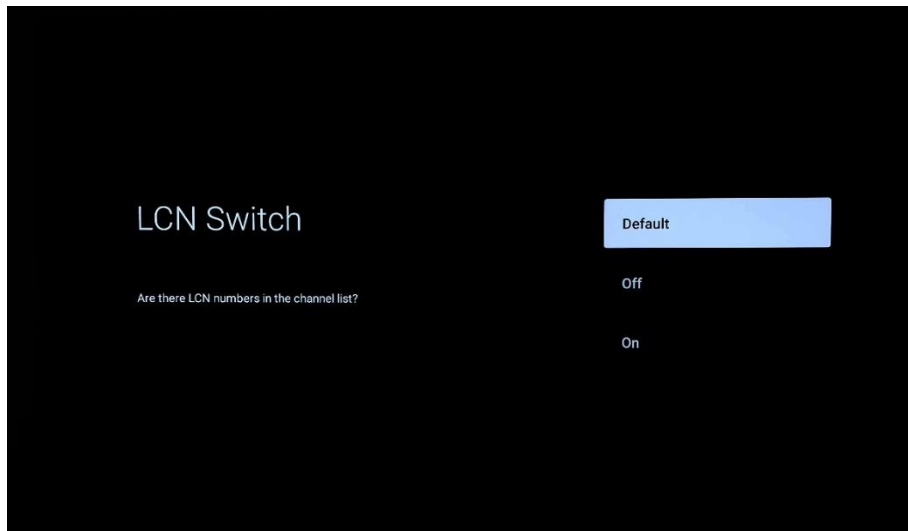

Default

Select the "Default" option to sort TV channels by the LCN (Logical Channel Number) sort order set by your selected TV provider or local area after the channel search process is complete.

Off

Select the "Off" option to sort the TV channels by channel frequency without a specific order.

On

Select the "On" option to sort the TV channels according to the LCN (Logical Channel Number) sort order set by your selected TV provider after the channel search process is completed.

6.4.1.10 Password

Press the **OK** button to input your 4-digit password and follow the steps on the screen. First you will need to choose a new password, then you need to confirm it again. You will need this password to edit functions, like parental controls or to reset your TV to the factory settings.

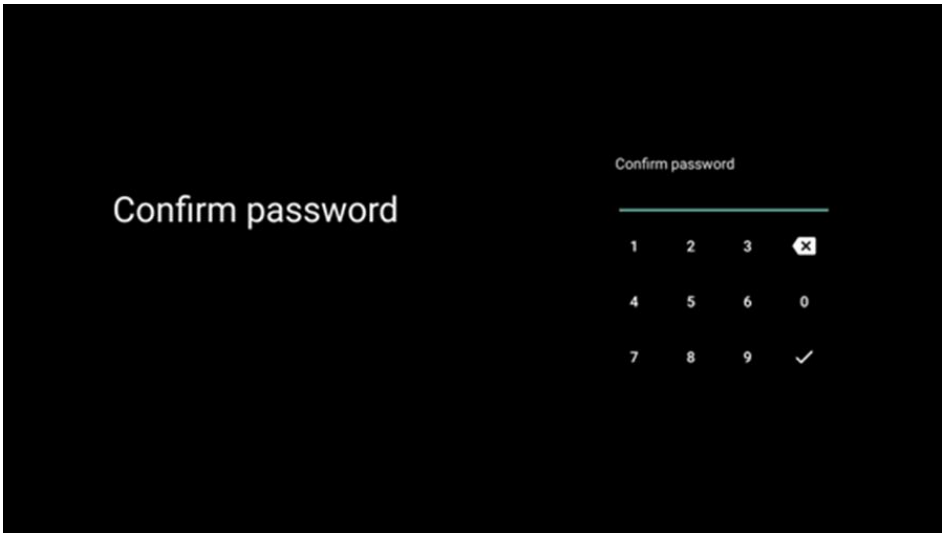
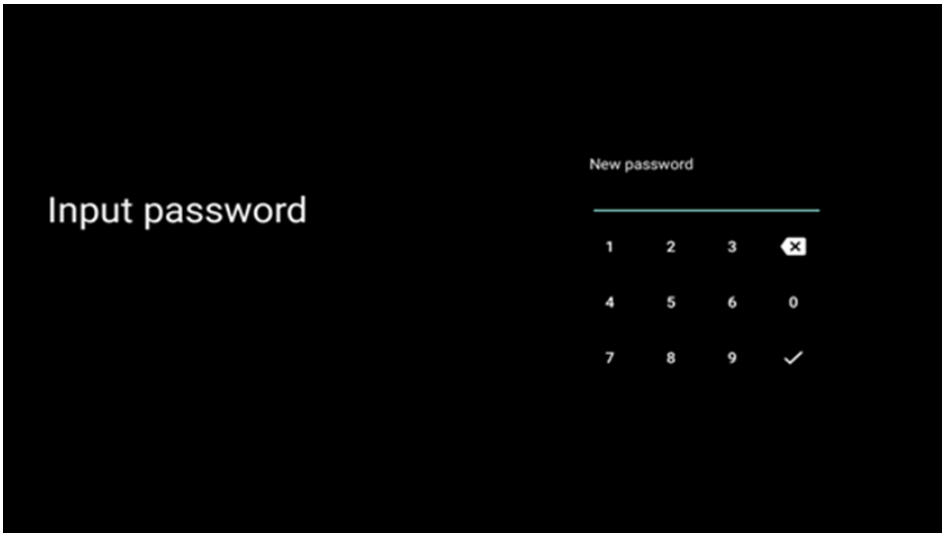
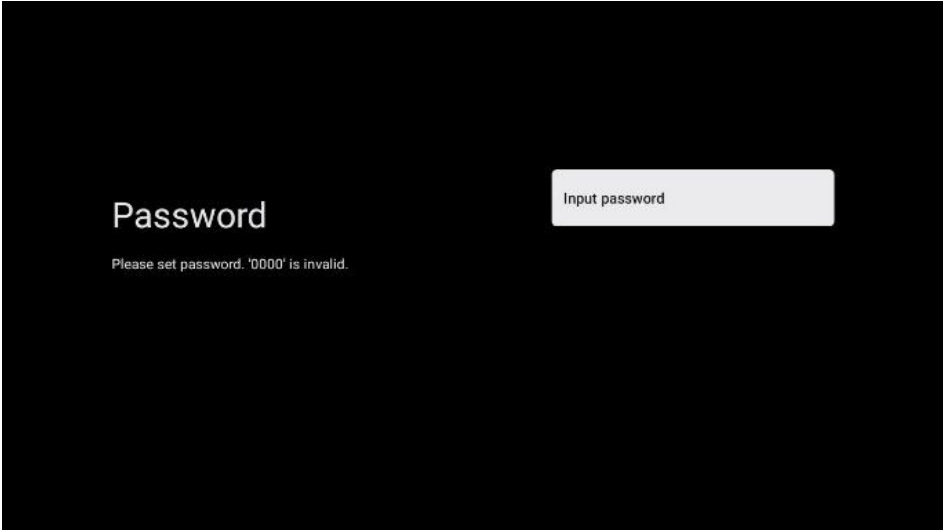

6.4.1.11 Select TV Mode (Home / Shop)

During the installation set-up, you have the option to customize your viewing experience by choosing your preferred TV mode. If you choose Home mode, your TV will function as usual, providing entertainment in your home environment.

Alternatively, selecting Shop mode will configure your TV to display pertinent information directly on the screen. This feature is commonly utilized in retail settings to showcase key details about the TV to potential customers.

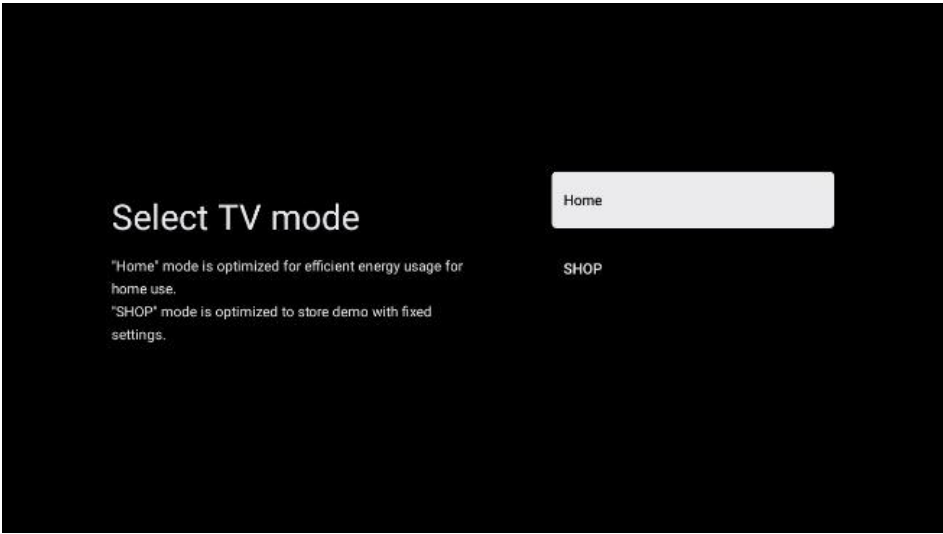

6.4.1.12 Google Cast

Activating the Chromecast function enables you to stream content from streaming applications directly to your TV, or to play digital multimedia content stored on your mobile devices, such as smartphones or tablets, on your TV screen.

6.4.1.13 Tuner Mode

The installation of the TV signal receiver tuner is described in detail in menu chapter 7.

6.4.2 Set up basic TV

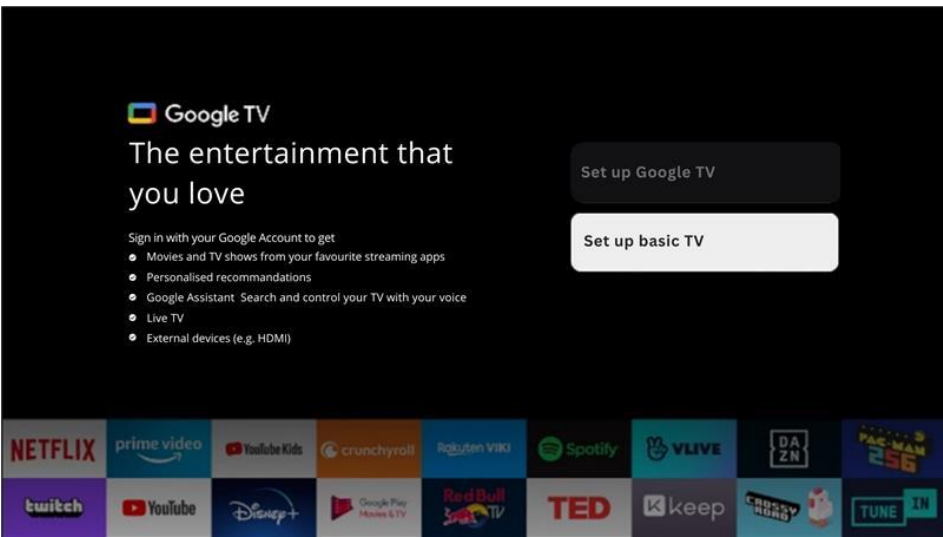

Please select the installation option Set up basic TV if you only want to use your TV to watch TV or listen to radio programs via terrestrial antenna, cable, or satellite antenna and if you do not want to connect your TV to the internet so that you can watch video contents from streaming Apps like YouTube or Netflix.

7 Tuner Mode

Select your TV reception type Tuner to install TV/Radio channels. The reception type options Terrestrial Aerial, Cable and Satellite are available. Highlight the available TV signal reception type option and press **OK** or click on the right directional button to continue.

If you select Skip scan, you can finish the first installation process of the TV without installing the TV channels. You can subsequently install the TV channels in the TV Settings Menu.

7.1 Antenna

If the Antenna option is selected, the TV will search for digital terrestrial and analogue broadcasts. On the next screen highlight the Scan option and press **OK** to start the search or select Skip Scan to continue without performing a search.

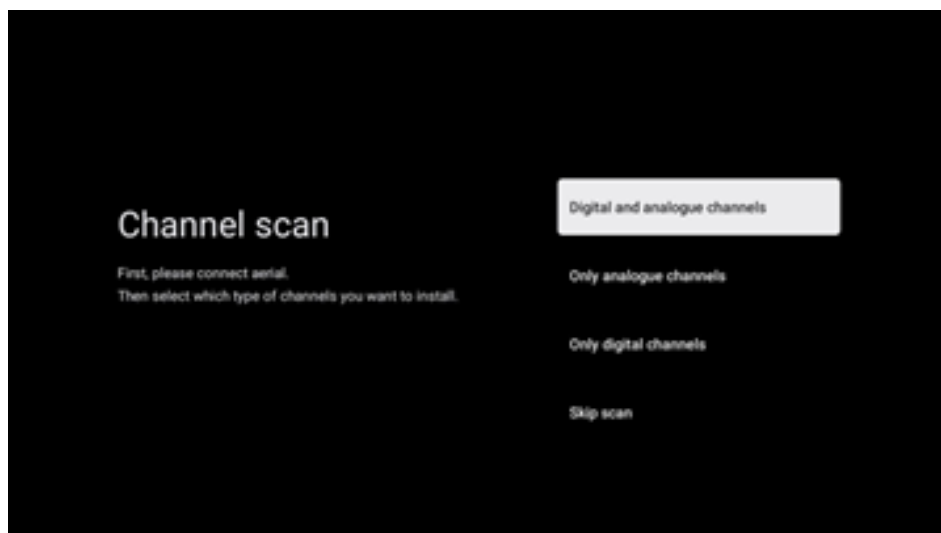

7.2 Cable

If the Cable option is selected, the TV will search for digital cable channels.

In most cable channel networks, only digital channels are available. Select Digital to continue the scan.

Operator Scan: If available, the cable operators will be listed on the screen. Highlight the desired operator and press **OK**. Select Start and press **OK** to perform the channel scan.

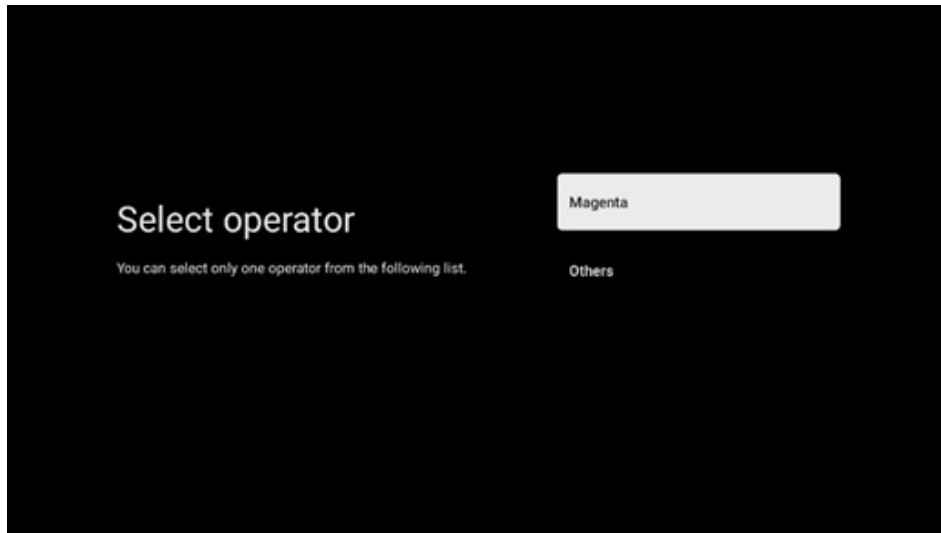

Others: Select the option Others if your cable operator is not listed or if your TV is connected to a local cable system. Select Scan Type and press **OK** to display the scan options.

Full scan: An automatic full search searches the entire frequency band; this should be selected if not all channels were found during a network search.

Quick scan: A quick search will be started, which will bring the channels into a pre-sorted order. With this type of search, it is necessary to enter the network ID and center frequency.

Network scan: With a network search, a complete and up-to-date channel list of a provider is transmitted, so the receiver recognizes all channels, which is preferable for cable TV operators. With this type of search, it is necessary to enter at least the network ID.

Select **Skip Scan** to continue without performing a search.

7.3 Satellite

Antenna type

Please set your antenna configuration.

Next

Select Next if your TV is connected to the satellite system with reception of only one satellite.

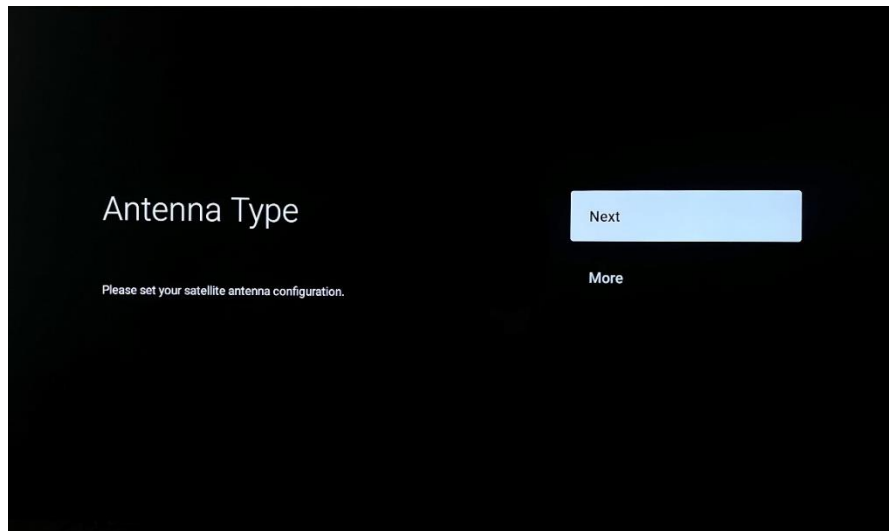

If Satellite option Next is selected, General Satellite and Operator scan options will be available. Select an installation option and press **OK** or click on the right directional button to continue.

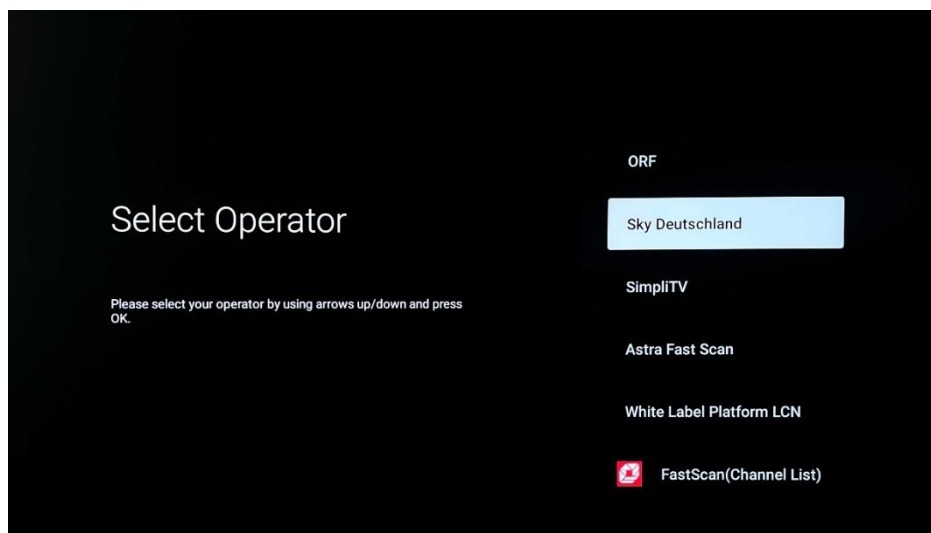

Note: General Satellite and Operator list options may not be available depending on the selected country.

Operator scan:

Highlight the desired operator and press **OK** to confirm your selection. Then press the right directional button to continue with the Operator scan.

You can only select one operator from the list. The TV/radio channels found are sorted according to the LCN order of the selected operator.

General scan:

With the General search option, the selected satellites are searched from the lowest to the highest satellite transponder frequency and the stored TV/radio channels will be listed one after the other according to the search progress in no particular order.

More

Select More if your TV is connected to a satellite system for reception of multiple satellites or to a 1-cable satellite system.

You will see the following screen with some available connection options. Select one of these options which is correct for your home satellite installation network. You may be able to set up different satellites depending on the selected antenna type.

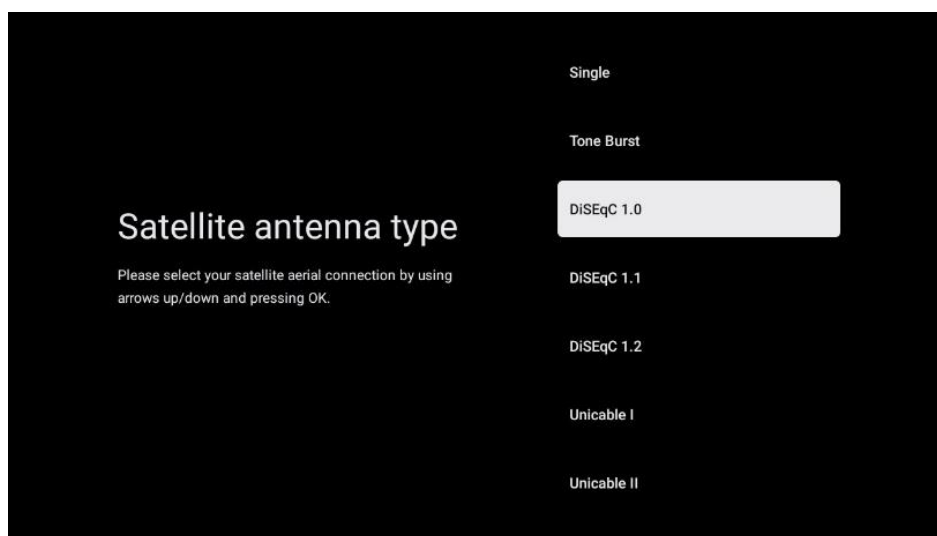

Following Satellite antenna connection types are available:

- **Single**- Satellite system with reception of only one Satellite.
- **Tone burst** – Satellite system with reception of two Satellites.
- **DiSEqC 1.0**- Satellite system with reception of 1-4 Satellites.
- **DiSEqC 1.1**-Extension of the DiSEqC 1.0 protocol and allows the control of multi-feed systems with up to 64 LNBS (Satellites) via the antenna cable.
- **DiSEqC 1.2** -is used to control a motor for rotary systems. The motor can save various positions, which are then approached automatically via DiSEqC 1.2.
- **Unicable I** - Unicable I is a method for distributing satellite TV signals in a satellite system. Several receivers can be connected to a single line. With Unicable I, up to 8 users can be connected to one antenna cable. More about the Unicable distribution system is described in the Channel Menu.
- **Unicable II** - This Unicable II satellite signal distribution system, also called Jess Unicable, is based on Unicable I digital channel stacking technology and enables installations with up to 32 satellite receivers connected over a single coax cable.

8 Home Screen

The Home screen is the centrepiece of your TV. From the Home screen, you can launch any installed Application, launch the Live TV application to watch the TV broadcast, watch a movie from various Streaming applications or switch to a device connected to the HDMI port. Also, you can exit the operation of any application at any time and return to the home screen by pressing the Home button on the remote control.

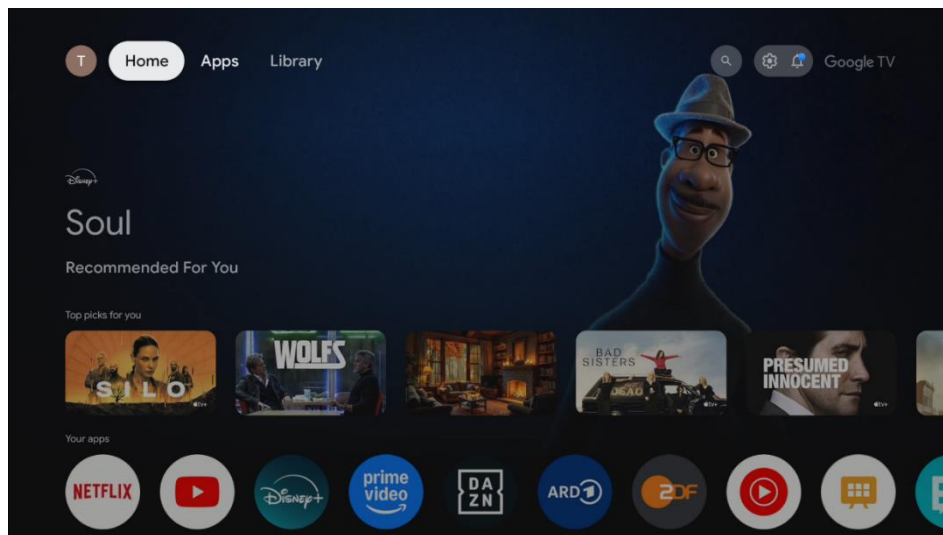

Note:

Depending on the settings of your TV set and your country selection during the initial setup, the Home menu may contain different elements.

In the first row, the streaming content of the streaming applications installed on your TV will be suggested according to your search criteria in your search history. Here you will also find the direct selection of the last TV input connection selected.

The second row is the row of applications. The most important applications for streaming services such as Netflix or YouTube as well as live TV and MMP (multimedia player) can be found in this first line. In this line you will also find the selection box with the last Input source. Select the application with the direction buttons on your remote control and confirm your selection with the OK button to start the selected application.

Select the application and press and hold the OK button to remove the selected application from the first row of favourites, move it to a new position or start it.

Select the last selection button "Show all" to display, start or edit the order of all applications installed on your TV.

The operation of the live TV application and the multimedia player is explained in a separate Menu chapter.

Further down on the home screen, you will find additional channels displayed by genre or streaming content category.

8.1 Google Account

Navigate to your profile icon at the top left corner and press "OK". Highlight profile icon and press "OK".

Here you can change your profile settings, add new Google account, or manage already existed accounts.

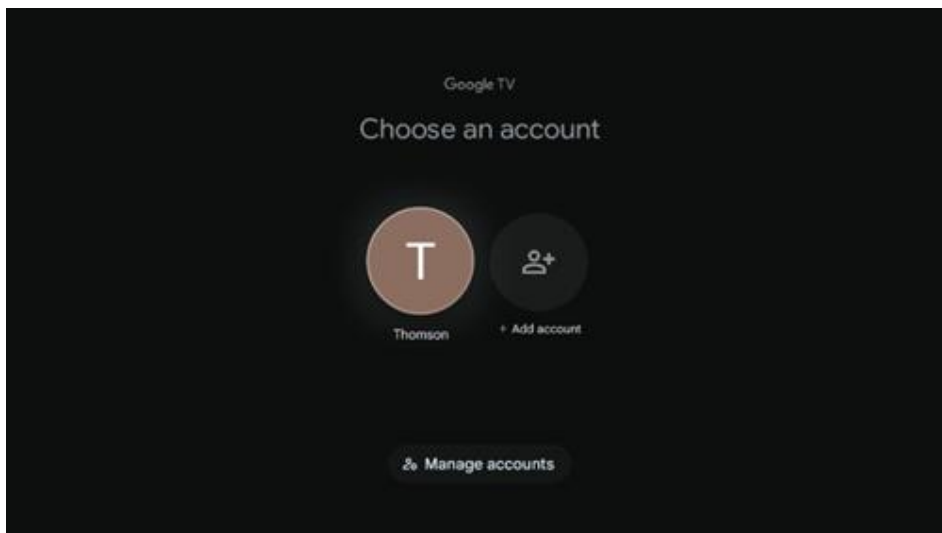

8.2 Apps

Select the Apps tab on the Home screen to display applications installed on your TV. Highlight a search bar to type in a name of an application you wish to install from Google Play Store.

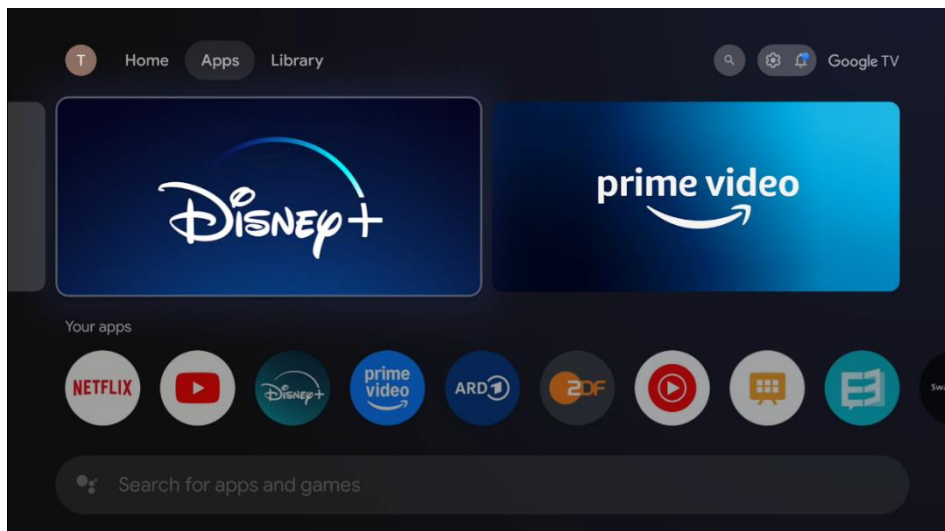

8.3 Library

Select the Library tab on the home page to play the streaming content you have already purchased or rented on your TV or mobile devices such as your mobile phone or tablet using your Google account.

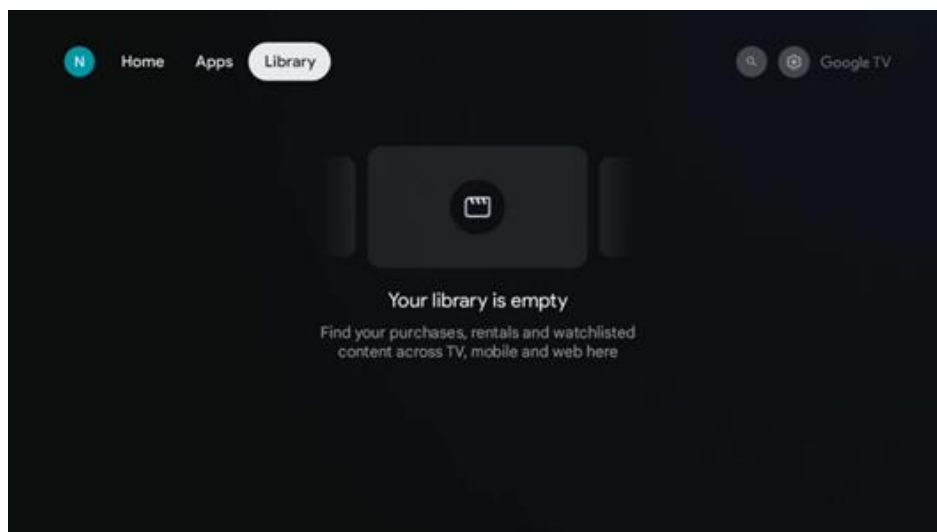

8.4 Google TV Search

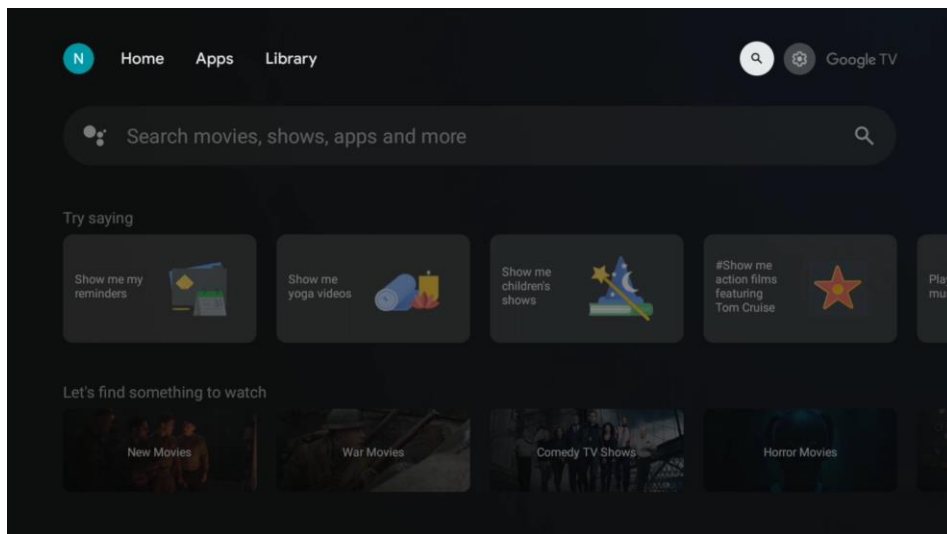

The search tools are located at the top left of the screen. You can either enter a word to start a search using the virtual keyboard or try voice search using the microphone built into your remote control. Move the focus to the desired option and press OK to continue.

Voice search – Press the microphone icon to start the voice search function. Google voice search field appears at the top of the screen. Ask your question to Google and your TV will answer you. For local search terms it is important that the Menu language of the TV is set to the local language.

Keyboard search – Select the search bar and press "OK". The virtual Google keyboard will appear on the screen. Type the question you want answered.

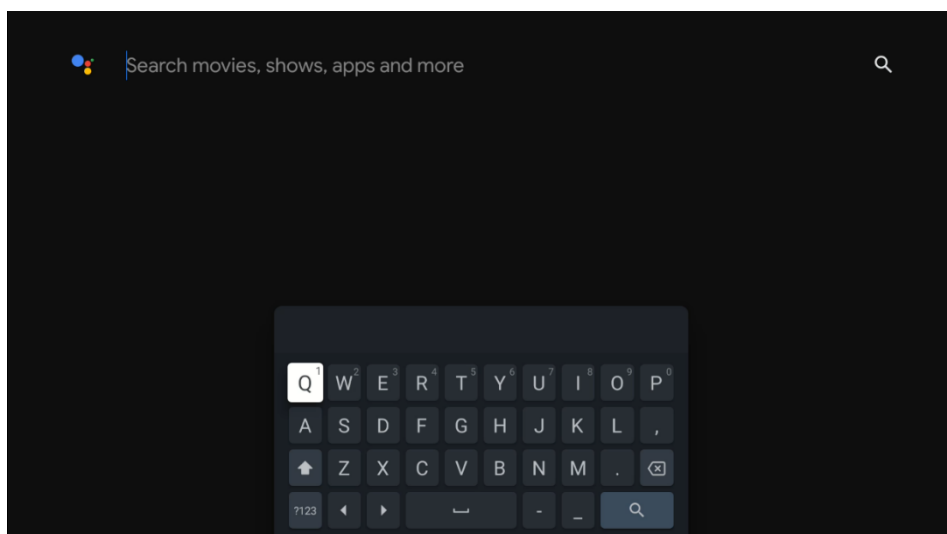

8.5 Notifications

Notification button appears only when there is one or more unread notifications. To check them, please, navigate to the Settings icon, the submenu will be opened. At the bottom of the submenu, you will be able to find all the latest notifications.

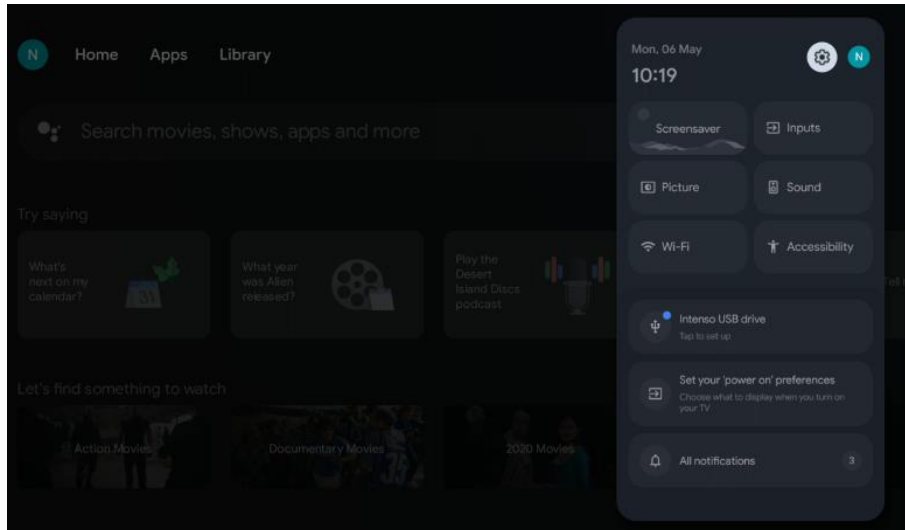

9 Settings

To enter full list of available settings, please, enter the Home Screen, by pressing (icon) Home Screen button, and navigate to the (icon) Settings button at the right top corner.

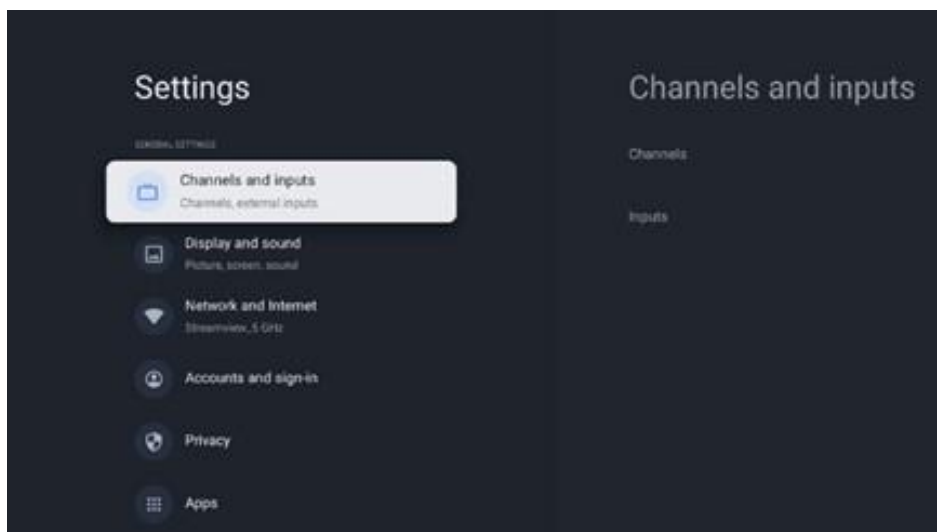

* The above pictures are for reference only, please refer to the product for details.

Note: During operation of media streaming application, like You Tube, Netflix, Prime Video etc., you by pressing **Settings** button, may enter **Display and Sound** menu, to tune Picture, Screen, Sound and Audio output setting without exiting the operation of media streaming applications.

9.1 Set your device name

In this menu you have the option to select the name of your TV from the list of suggested names. You can also assign a customised name for your TV.

This is important for the operation of the Chromecast function so your TV will be identified with the correct name. By assigning the TV name, your TV will also be correctly identified in your home network.

9.2 Channels and inputs

The settings for Channels scanning and available Inputs are displayed in this menu section.

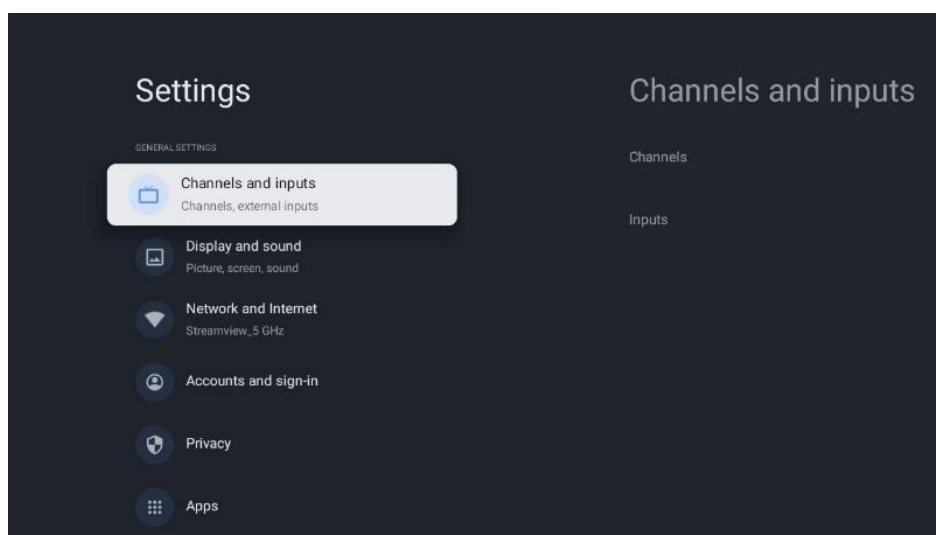

9.2.1 Channels

In this menu you can select the reception tuner installation mode according to your TV signal reception type.: Analogue, Antenna, Cable or Satellite.

Select the mode and press „**OK** “to proceed to the tuning.

9.2.1.1 Analogue

- **Channel scan:** Press the OK button on the remote control to perform the automatic search for Analogue channels. When the scanning process is finished, press the Back button to return to the previous Menu.
- **Update scan:** Press the OK button on the remote control to perform the automatic search to update the channel list, which results in added new channels or updated information of the current channels.
- **Analogue Manual scan:** Press the OK button to manually choose a starting frequency and the direction of the scan.

9.2.1.2 Antenna

- **Chanell Scan:** Press the OK button on the remote control to perform the automatic search for DVB-T/T2 channels. When the scanning process is finished, press the Back button to return to the previous Menu.
- **Update Scan:** Previously added channels will not be deleted, but any newly found channels will be stored in the channel list.
- **Single RF Scan:** Select the RF Channel by using the Right/Left directional buttons. Signal Level and Signal Quality of the selected channel will be shown. Press OK to start scan on the selected RF channel. The found channels will be stored in the channel list.
- **Manual service update:** This function will start the update of the receivable TV/radio channels manually.
- **LCN:** Set your preference for LCN. LCN is the Logical Channel Number system that organizes available broadcasts in accordance with a recognizable channel number sequence (if available).
- **Channel scan type:** Set your scan type preference.
- **Channel store type:** Set your store type preference.
- **Favourite Network Select:** Select your favourite network. This menu option will be active, if more than one network is available.

9.2.1.3 Cable

Channel scan: The Smart TV searches for digital and analogue channels that can be received via cable. Depending on the country, optional DVB-C cable TV providers are offered during the initial installation and are listed on the Channel scan list screen. If you receive the DVB-C signal from a non-dedicated cable TV provider, select the option Others. Press OK to start the channel search. In the Channel scan menu, you can select one of the three channel search options: Full, Advanced, or Quick.

- **Full:** Automatic search of all available DVB-C channels.
- **Advanced:** Automatic search of all available DVB-C channels. For this option, it is necessary to enter the DVB-C provider's reception parameters, frequency and network ID. With this search option, the channels are sorted by LCN of the cable providers.
- **Quick:** Automatic search for all available DVB-C channels. This search will search all available cable transponders with the standard symbols.

Single RF Scan: Manual search of DVB-C channels by transponder frequency.

LCN: LCN options for DVB-C channel search.

Channel Scan Type: Set your scan type preference.

Channel Store Type: Set your store type preference.

9.2.1.4 Satellite

First, you have to choose which channel installation mode to use.

Channel installation Mode - Preferred Satellite

- **Satellite Re-scan:** The satellite search process will be performed again.
- **Satellite Add:** This function is useful when the General Satellite option is selected as the TV signal type. When the Preferred Satellite option is selected, DiSEqC settings will be automatically determined and channels from new satellite providers will be added from new selected satellites, depending on the selected satellite provider.
- **Satellite Update:** If you select the Scan function, the receivable satellites and the corresponding DiSEqC settings will be determined automatically and the new channels will be added.
- **Satellite Manual Tuning:** Select the satellite on which you want to perform the manual search of the satellite transponder and press OK. Set the exact reception parameters of the desired satellite transponder (frequency, symbol rate and polarization). Make sure that the signal quality and signal level indicate a sufficient value and press the Back button. Press the Right directional button to start the search. The found programs will be saved at the end of the program list.

Channel installation Mode - General Satellite

- **Satellite Re-scan:** The satellite search process will be performed again. As an option, you can activate another receivable satellite and add it to the automatic search. Select another satellite and press OK. Set the exact reception parameters of the desired satellite, the DiSEqC connections and the reception parameters of a receivable satellite transponder (the frequency, the symbol rate, and the polarization). Make sure that the signal quality and signal level indicate a sufficient value and press the Back button. Press the Right directional button to start the scan. The found programs will be saved at the end of the program list.
- **Satellite Add:** Press OK to set the reception parameters of the satellite you want to add. Activate the satellite in the satellite status and set the exact reception parameters of the desired satellite. Set the DiSEqC ports and the reception parameters of a receivable satellite transponder (the frequency, the symbol rate, and the polarization). Make sure that the signal quality and signal level indicate a sufficient value and press the Back button. Press the Right directional button to start the scan. The found channels will be stored at the end of the channel list.
- **Satellite Update:** The channel scan of the selected satellites will be started and new channels will be added to the channel list automatically.
- **Satellite Manual Tuning:** Select the satellite on which you want to perform the manual search of the satellite transponder and press OK. Set the exact reception parameters of the desired satellite transponder (frequency, symbol rate and polarization). Make sure that the signal quality and signal level indicate a sufficient value and press the Back button. Press the Right directional button to start the search. The found programs will be saved at the end of the program list.

9.2.1.5 Auto Channel Update

This function enables automatic channel updates. By default, it remains deactivated. If you've individually sorted channels to maintain a specific order, it's advisable to keep this function disabled.

9.2.1.6 Channel Update Message

This function enables automatic channel updates. By default, it remains deactivated. Enable this function if you'd like to receive on-screen notifications when new channels become available.

Parental controls: This menu allows you to configure parental control options. To access it, you'll need to enter the PIN code you set during the initial TV setup process.

Open-source licences: Here you will find information about Open-Source licences.

9.2.2 Inputs

Here you will find information about devices connected to the HDMI inputs of your TV and the HDMI-CEC operation options.

Connected input: Here, are listed devices connected to the Aux or HDMI connections of your TV. You can rename the connection or assign individual device name for specific connection.

Standby Inputs: Here are listed the available HDMI inputs.

Unconnected Input: Here are listed the connections to which no device is connected.

Consumer Electronic Control (CEC – HDMI Link)

With CEC function of your TV, you can operate a connected device with the TV remote control. This function uses HDMI CEC (Consumer Electronics Control) to communicate with the connected devices. Devices must support HDMI CEC and must relate to an HDMI connection.

The TV comes with the CEC function switched on. Make sure that all CEC settings are properly set up on the connected CEC device. The CEC functionality has different names on different brands. CEC function might not work with all devices. If you connect a device with HDMI CEC support to your TV, the related HDMI input source will be renamed with the connected device's name.

To operate the connected CEC device, select the related HDMI input source from the Inputs menu on the Home Screen. Or press the Source button if the TV is in Live TV mode and select the related HDMI input source from the list. To terminate this operation and control the TV via

the remote again, press the Source button, which will still be functional, on the remote and switch to another source.

The TV remote is automatically able to control the device once the connected HDMI source has been selected. However not all buttons will be forwarded to the device. Only devices that support CEC Remote Control function will respond to the TV remote control.

HDMI Control On/Off: Allow the TV to control HDMI devices.

Device auto power Off: Power Off HDMI devices with the TV

TV auto power on: Power on the TV with HDMI device

HDMI Link device list: Here are listed the devices that support the HDMI Link function and are connected to your TV.

9.3 Display and Sound

Adjust Picture, Screen, Sound and Audio output settings for your preference.

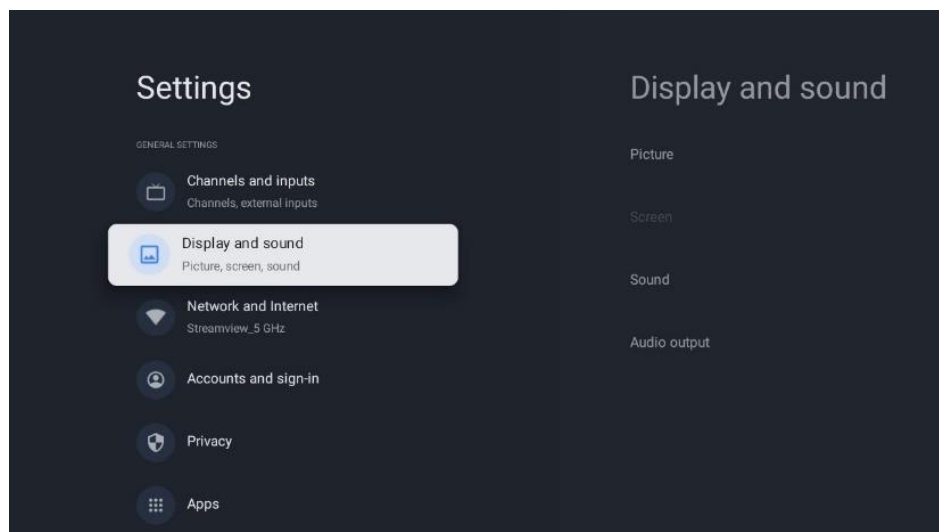

9.3.1 Picture

Here you can adjust Picture settings.

9.3.1.1 Picture Mode

In the initial installation of the TV, by default, the TV is set in "Energy saving" picture mode. Select one of the picture mode presets or you can manually adjust Picture settings for your preferences in „User „mode (refer to 9.2.1.2).

9.3.1.2 Manual Picture Adjustments

Adjustments you can make:

- **Backlight**
Changes the level of backlight, adjusting the level of illumination of the TV display panel
- **Auto brightness**
When On, the TV adapts the brightness of its display in accordance with the brightness of the surroundings
- **Brightness**
Changes the level of light emitted from the TV from darker to brighter
- **Contrast**
Changes the level of contrast adjusting the picture luminating or the white brightness level, therefore, changing the brightness of all colors
- **Saturation**
Changes the level of saturation, adjusting the intensity or vividness of colors on the display
- **HUE**
Changes the angular representation of the color values in an image. By adjusting the level, you remap the colors throughout an image
- **Sharpness**
Changes the sharpness level, adjusting the edge enhancement
- **OLED**
OLED Compensation: Automatic panel noise clearing operation. If you start this operation, the screen will turn off. Please, do not disconnect the TV from the power supply during this operation process until the TV flashes 3 times on the bottom bar. This process may take a few minutes after you can turn on the TV with the remote control.
Manual Off-RS Compensation: The TV will calibrate the screen after it is switched to standby. This process takes about 15 minutes. Please do not disconnect the TV from the power supply during this time. Select the option in the dialog screen (OK if this operation should be performed or No if this operation should not be performed).
Pixel Shift: Pixel shift is a feature designed to prevent image retention on the TV screen by slightly moving the displayed image after a specific time.

9.3.1.3 Advanced Settings

- **Colour temperature:** Set your colour temperature preference. User, Cool, Standard and Warm options will be available. You can adjust red, green and blue gain values manually. If one of these values is changed manually, Colour Temperature option will be changed to User, if not already set as User.
- **Dolby Vision notification** - The user will be informed on the TV screen in the Pop -Up message window whether the Multimedia or Streaming content is played in Dolby Vision.
- **DNR:** Dynamic Noise Reduction (DNR) is the process of removing noise from digital or analogue signal. Set your DNR preference as Low, Medium, Strong, Auto or turn it off by setting as Off.
- **MPEG NR:** MPEG Noise Reduction cleans up block noise around outlines and noise on the background. Set your MPEG NR preference as Low, Medium, Strong or turn it off by setting as Off.
- **Max Vivid:** This picture menu option, On/Off, significantly increases the contrast,

brightness and sharpness.

- **Adaptive Luma Control:** Adaptive Luma control adjusts contrast settings globally according to content histogram to provide deeper black and brighter white perception. Set your Adaptive Luma Control preference as Low, Medium, Strong or turn it off by setting as Off.
- **Local contrast control:** Local contrast enhancement attempts to increase the appearance of large-scale light-dark transitions, like how sharpening with an "unsharp mask" increases the appearance of small-scale edges.
- **Filmmaker Mode** - Filmmaker Mode allows your TV to present movies and shows exactly as the filmmaker intended by turning off all post-processing effects, such as motion smoothing, and maintaining the original aspect ratios, colours, and frame rates. In this menu you have the option to activate or deactivate the Filmmaker mode and to activate or deactivate the Auto switch option.
- **Flesh tone:** The Flesh Tone option allows you to refine the flesh colours in the pictures without affecting the other colours on the screen
- **DI Film Mode:** It is the function for 3:2 or 2:2 cadence detection for 24 fps film contents and improves the side effects (like interlacing effect or judder) which are caused by these pull-down methods. Set your DI Film Mode preference as Auto or turn it off by setting as Off. This item will not be available if Game Mode or PC Mode (optional) is turned on.
- **Blue Stretch:** Human eye perceives cooler whites as brighter white, Blue Stretch feature changes White balance of mid-high grey levels to cooler colour temperature. Turn the Blue Stretch function on or off.
- **Gamma:** Set your gamma preference. Dark, Middle and Bright options will be available.
- **FPS Display:** Activate this function to enhance visibility in First-Person Shooter games, making dark areas of the screen brighter and easier to see.
- **Game Mode:** Game mode option will be activated optionally when the game console is connected to one of the HDMI 120 HZ ports. Game mode is the mode which cuts down some of the picture processing algorithms to keep up with video games that have fast frame rates. Turn the Game Mode function on or off.
- **ALLM: Auto Low Latency Mode** enables the ideal latency setting to automatically be set allowing for smooth, lag-free and uninterrupted viewing and interactivity.
- **PC Mode:** PC mode option will be activated as an option when the PC is connected to one of the HDMI 120 HZ ports.

Note:

To ensure 120 FPS and to enable PC/Game mode on your TV, please use a proper HDMI 2.0/2.1 cable and connect one side to your system and another to the HDMI2 or HDMI3 TV port.

The TV will automatically recognize the signal source and set itself to PC/Game mode. Please, note that Game mode is available on a system with a dedicated Graphics Processing Unit (GPU). Game mode allows to lower the response time of your TV. For better gaming experience, please use HDMI 2.1 cable. Here are the differences between HDMI 2.0 and HDMI 2.1.

Feature	HDMI 2.0	HDMI 2.1
Bandwidth	18 Gbps	48 Gbps
Resolution	4K at 60Hz	8K at 60Hz, 4K at 120Hz
Refresh Rate	Up to 60Hz	Up to 120Hz
HDR Support	HDR10	HDR10+, Dynamic HDR
Audio Channels	32 audio channels	Enhanced Audio Return Channel (eARC)
Data Rate	4K at 60Hz	8K at 60Hz, 4K at 120Hz
Latency	Standard	Auto Low Latency Mode (ALLM)
Variable Refresh Rate	Not Supported	Supported

You can manually select the mode, if both are available on your connected system, by clicking Settings button, then proceeding to Picture and then to Advanced settings. You will see PC mode and Game mode options by scrolling down the menu.

- **De-Contour:** The De-Contour feature in the picture settings of OLED TVs is designed to reduce banding artifacts or "contours" in areas with subtle color gradients, such as skies, shadows, or fog. Banding occurs when transitions between colors are not smooth, creating visible lines or blocks instead of a seamless gradient.
- **AISR:** This setting enhances the upscaling of 1080i or 1080p videos to 4K Ultra HD or 8K Ultra HD resolution, though lower resolution videos do not benefit from this processing. It specifically allows for upscaling content, such as Blu-ray ISO, M2TS, or MKV files, to 1080p for high-quality display on 4K or 8K TVs or projectors. This advanced upscaling uses artificial intelligence to reconstruct the image, creating additional pixels rather than merely modulating luminance or oversampling subpixels (as in typical 4:2:0 chroma upscaling). As a result, the output can closely resemble the native 4K version of the content, enabling you to fully utilize the resolution of your 4K or 8K display when playing 1080p video files.
- **MEMC:** Motion Estimation, Motion Compensation. This technology enhances the smoothness of video playback by inserting additional frames between the original ones. By analysing the motion in consecutive frames, MEMC calculates and generates intermediate frames, effectively increasing the frame rate of the scene. This results in smoother motion, especially during fast-paced sequences, making the viewing experience more fluid and comfortable.
- **HDMI RGB Range:** Adjust this setting if your TV supports RGB full range. The colour scale range for RGB video signals can vary based on the type of TV you are using. Ensure this setting is properly configured to match your TV's capabilities for optimal colour accuracy and picture quality.
- **Eye Protection Mode:** Compared to LCD displays, OLED displays are considered more eye-friendly due to their lower blue light emission. A blue light level of around 50% is

considered gentle and well-tolerated for the eyes.

- **Colour space:** Defines the spectrum of colours supported by the TV, influencing the richness and accuracy of colour representation on the screen.
- **Specular Boost:** enhances the brightness and clarity of highlights in scenes, particularly in HDR (High Dynamic Range) content. It focuses on boosting specular highlights—small, intense points of light like reflections, glints, or bright sunlight—making them more vivid and realistic.
- **Colour tuner:** Colour saturation, hue, brightness can be adjustable for red, green, blue, cyan, magenta, yellow and flesh tone (skin tone) for having more vivid or more natural image. Set the Hue, Colour, Brightness, Offset and Gain values manually. Highlight Enable and press OK to turn this function on.
- **11 Point White Balance Correction:** White balance feature calibrates TV's colour temperature in detailed grey levels. By visually or measurement, grey scale uniformity can be improved. Adjust the strength of the red, green, blue colours and Gain value manually. Highlight Enable and press OK to turn this function on.

9.3.1.4 Reset to default

Reset the video settings to factory default settings.

Note: Depending on the currently set input source some menu options may not be available.

9.3.2 Sound

In this Menu you can adjust Sound settings.

9.3.2.1 Dolby Processing

Dolby Audio Processing (DAP) is a collection of advanced post-processing technologies aimed at enhancing the audio quality during TV playback. Press the OK button to access the Dolby Processing menu.

- **Dolby processing Enabled / Disabled** - Here you can activate or deactivate the Dolby processing function. The Dolby processing function is activated by default.
- **Sound Mode** - Set your sound preference. Game, Movie, Music, News, Stadium, Standard and User options are available.
- **Volume Leveler**- Volume Levelling automatically regulates the audio output to ensure a consistent volume, regardless of the variation in the source material.
- **Surround Virtualizer** - Virtual Surround is an audio feature designed to create the illusion of multiple sound sources, enhancing the sense of depth and immersion beyond the actual number of speakers.
- **Dolby Atmos** - Dolby Atmos delivers immersive sound that surrounds you from every direction, placing you at the centre of your movies, TV shows, sports, games, and music. Enhance your home theatre experience with Dolby Atmos for a truly captivating audio experience. Here you can activate or deactivate the Dolby processing function. The Dolby processing function is activated by default.

9.3.2.2 Sound Style

Sound style can be set when Dolby processing is deactivated. Optionally select User, Standard, Vivid, Sports, Movie, Music or News sound style.

- **Balance:** Here you can set the speaker balance.
- **Bass:** Here you can set the Bass level.
- **Treble:** Here you can set the Treble level.
- **Surround Sound:** Here you can enable or disable Surround sound. : This menu option is available for Multimedia or Live TV playback content that includes surround sound.
- **Equalizer Detail:** Here you can set the Equalizer individually if Dolby processing is deactivated and Sound Style "User" is selected.
- **Speakers:** Here you can deactivate the TV speakers if, for example, the TV is connected to an external AV amplifier system or soundbar.
- **eARC:** Here you can deactivate the eARC function that is available on the HDMI 1 port.
- **Auto Volume Control:** The Auto Volume feature helps maintain consistent sound levels across different channels. When enabled, it prevents sudden volume spikes when switching channels, providing a stable and smooth audio experience.
- **Downmix Mode: Audio Downmixing** involves converting a multi-channel audio signal into a stereo signal, such as downmixing 5.1 or more channels into just 2 channels. When paired with Video Distribution, you're transmitting a single video source to multiple outputs while simplifying the audio for stereo playback.
- **Dialogue Enhancer:** Enhanced Dialog mode allows users to boost the clarity of spoken dialogue, ensuring that conversations remain clear and distinct, even in scenes with loud background noises like explosions or music.
- **Reset to default:** Resets the sound settings to factory defaults.

9.3.2.3 Manual Sound Adjustments

Adjustments you can make:

- **Sound Style:** For easy sound adjustment, you can select a preset setting. User, Standard, Vivid, Sport, Movie, Music, or News options will be available. Sound settings will be adjusted according to the selected sound style.
- **Balance:** Adjust the left and right volume balance for speakers and headphones
- **Bass:** Adjust the level of the low tones.
- **Treble:** Adjust the level of the low tones.
- **Surround sound On/Off:** Activates the surround mode of the TV speakers.
- **Equaliser detail:** Setting the Equalizer parameters in User sound mode. Note: You can select one of the pre-installed sound modes offered in this menu or set Balance, Bass, Treble, Surround sound or Equaliser detail only if Dolby Audio processing is deactivated.
- **Speakers On/Off:** Enable or disable TV speakers.
- **Speaker Delay:** Here you can adjust the delay of the speaker sound.

- **Auto volume control:** With Auto Volume Control, you can set the TV to automatically level out sudden volume differences. Typically, at the beginning of adverts or when you are switching channels. Select this option and press the OK button to switch it On or Off.
- **Downmix mode:** Set your preference to convert multi-channel audio signals to two-channel audio signals. Press OK button to see the options and set. Stereo and Surround options will be available. Highlight the option you prefer and press OK button to set.
- **Dialogue enhancer:** Automatically adjusts the sound of dialogues, making them stand out from other sounds.
- **Reset to default:** Resets the sound settings to factory defaults.

9.3.3 Audio Output

Digital output: Set the digital sound output preference. Auto, Bypass, PCM, Dolby Digital Plus and Dolby Digital options will be available. Highlight the option you prefer and press OK to set.
Digital output delay: Here you can adjust the delay of the SPDIF delay value

9.4 Network & Internet

You can configure your TV's network settings using the options of this menu.

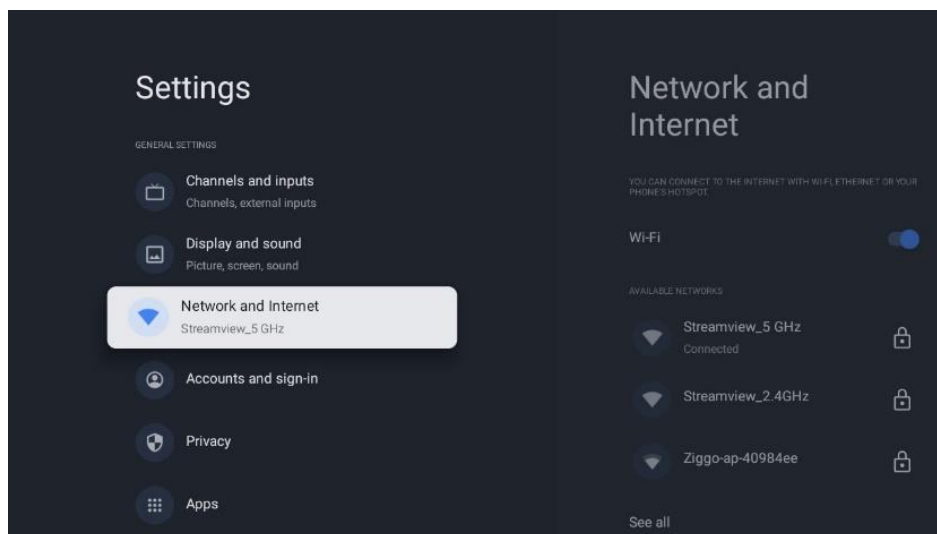

9.4.1 Wi-Fi On/Off

Turn the wireless LAN (WLAN) function on and off.

9.4.2 Choose available Wi-Fi Network

When the WLAN function is turned on, available wireless networks will be listed. Highlight "See all" and press OK to see all networks. Select one and press OK to connect. You may be asked to enter a password to connect to the selected network in case the network is password protected.

9.4.3 Other options

- **Add new network:** Add networks with hidden SSID's
- **Data saver:** Automatically adjusts video quality to use fewer mobile data. It will monitor and limit your network traffic.
- **Data usage and alerts:** Showcases the amount of data used per day and allows you to set data alerts.
- **Scanning always available:** You can let the location service and other apps scan for networks, even when WLAN function is turned off. Press OK to turn it on and off.

9.4.4 Ethernet options

- **Connected / Not connected:** Displays the status of the internet connection via Ethernet, IP and MAC addresses.
- **Proxy settings:** Set a HTTP proxy for browser manually. This proxy may not be used by other apps.
- **IP settings:** Configure your TV's IP settings.

9.4.5 Others

Network privacy policy: Read about network privacy policy and accept or decline it.

Wake configs:

- **WoW:** Turn the Wake on WLAN function on and off. This function allows you to turn on or awaken your TV via wireless network.
- **WoL:** Turn the Wake on LAN function on and off. This function allows you to turn on or awaken your TV via network.

9.5 Accounts & Profiles

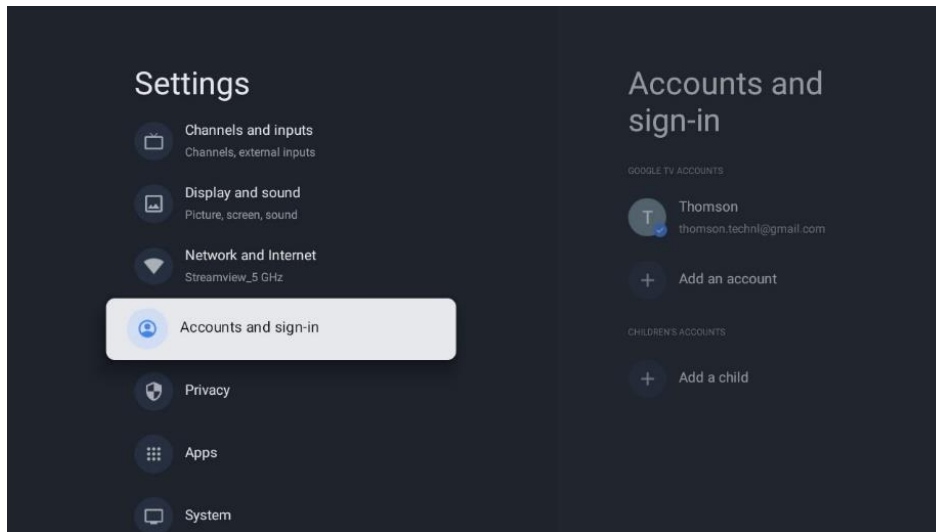

Google TV account: This option will be available if you have signed in to your Google account. You can lock your account preferences, configure your data syncing preferences, manage your payments and purchases, adjust Google Assistant settings, enable Apps-only mode, and remove the account from your TV.

Add account: Add a new one to available accounts by signing in to it.

Add a child: Add a child friendly account with parental protection.

9.6 Privacy

Here you can change and adjust your privacy settings and apps permissions.

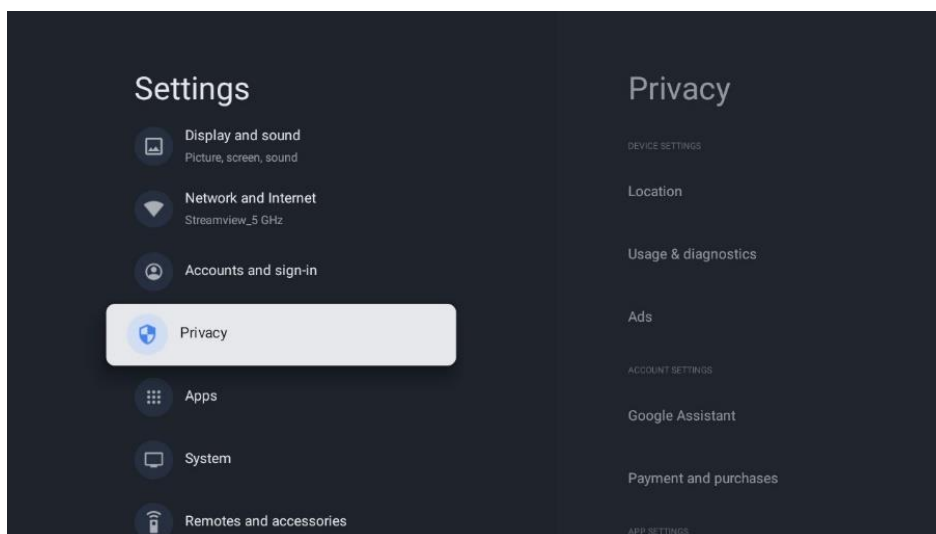

Device settings:

- **Location:** Select whether Google may collect location data according to your Wi-Fi. It is important that you provide Google with your location because the installation of many applications depends on the Geo-location. Installation of certain streaming applications, especially those that stream TV broadcast channels, is only possible according to Geo-location rules.
- **Usage & diagnostic:** Automatically send diagnostic information to Google.
- **Ads:** Select whether Google is allowed to collect usage data and diagnostics and promote to you personalized ads.

Account settings:

- **Google assistant:** Select your active account, view the permissions, select which applications should be included in the search results, activate the secure search filter and view the open-source licences.
- **Payment and purchases:** Setup Google Payment and Purchases settings.

App settings:

- **App Permissions:** Refer to the controls that determine what access and capabilities each installed app has on your device. These permissions may include access to your location, camera, microphone, storage, and other device features.
- **Special app access:** Select which apps can have access to your information and have special access.
- **Security and restrictions:** You can use the options in this menu to allow or restrict the installation of apps from sources other than the Google Play Store. Set the options so that your TV does not allow or warns against the installation of apps that could cause serious issues.

9.7 Apps

Use the options in this Menu to manage the applications installed on your TV.

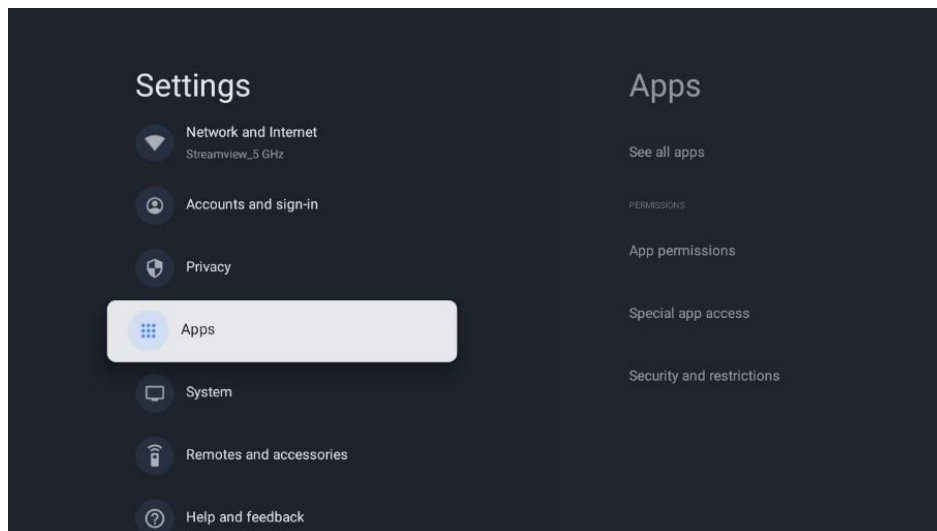

Recently opened apps: Recently opened apps are displayed here.

See all apps: Select " See all apps" and press OK to display a comprehensive list of all installed apps on your TV. You will also be able to see the storage space each App occupies. From there you can check App versions, start or force stop their operation, uninstall downloaded Apps, check permissions and switch them On or Off, manage notifications, clear data and cache and much more. Simply highlight an App and press OK to access the available options.

Permissions: Manage the permissions and some other features of the apps.

- **App permissions:** The apps will be sorted by permission type categories. You can enable disable permissions for the apps from within these categories.
- **Special app access:** Configure some app features and special permissions.
- **Security & restrictions:** Using the options of this menu; You can allow or restrict installation of apps from sources other than the Google Play Store. Set the TV to disallow or warn before installation of apps that may cause harm.

9.8 System

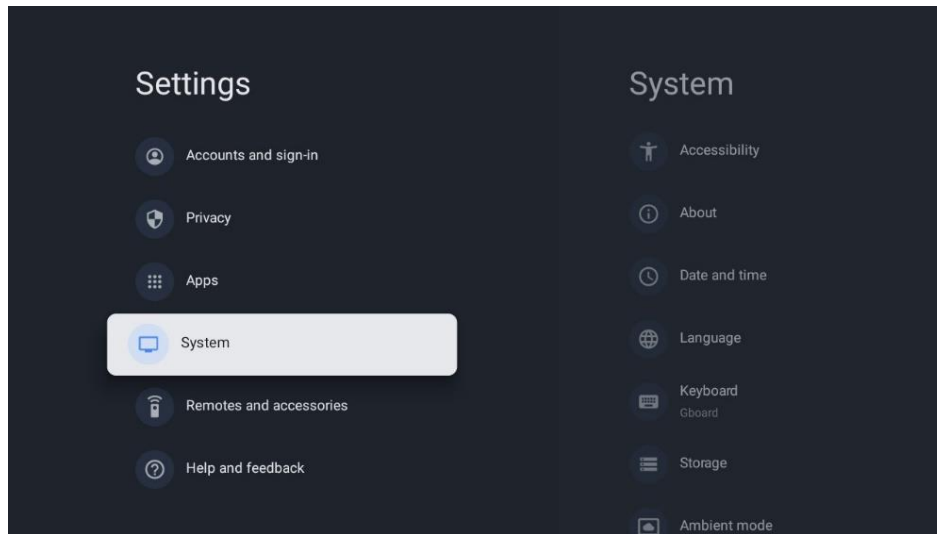

9.8.1 Accessibility

Here you can turn on/off captions, adjust their language and text size, choose caption style.

Enable or disable high-contrast text.

Enable or disable Google's "Text to speech" function. This function will automatically voice text displayed on your screen. It is useful function for people with eyesight problems. In this menu section you may adjust settings for "Text to speech" such as speech rate and default language.

9.8.2 About

Here you can find Hardware and Software information about your TV as well as Android OS and Netflix ESN version.

- **System update:** Select this Menu option and press OK on your remote control to check if a software update is available for your TV.
- **Device name:** Select this Menu option and press OK button on your remote control to change the name or assign a customised name for your TV. This is important because your TV should be correctly identified in your network or when performing the Crome cast function.
- **Reset:** Select this Menu option to reset your TV to factory settings and reinstall your TV.
- **Status:** In this Menu you will find the HW information of your TV such as IP address, MAC address, Bluetooth address, Serial number and Uptime.
- **Legal information:** In this menu you will find the Legal information of your TV.
- **Model:** Shows you the model of your TV.
- **Android TV OS version:** Shows you which OS version is installed on your TV.

- **Android TV OS security patch level:** Shows the date of the security patch installed on your TV.

9.8.3 Date and Time

Set the date and time options on your TV. You can set your TV so that the time and date data is updated automatically via the network or via the broadcasts. Set them according to your environment and preferences. Deactivate the "Automatic date & Time" option if you want to change the date or time manually. Then set the date, time, time zone and hour format options.

9.8.4 Language

Set the Menu language of your TV.

9.8.5 Keyboard

Select your virtual keyboard type and manage keyboard settings.

9.8.6 Storage

The total storage space status of the TV and the connected devices, if available, is displayed here. To view detailed usage information, highlight Internal storage partition or External storage connected device and press OK. Options for ejecting and formatting the connected storage devices are also displayed.

9.8.7 Ambient mode

Ambient mode on a TV is a feature that transforms the TV screen into a digital photo frame or virtual art display when not in use. You can manually start this mode in this menu section.

Channels: Choose the source of photos or images to show in ambient mode.

More settings:

- Display weather using C or F. You may choose to show both degree systems or hide degrees at all
- Display or hide time
- Adjust personal photos
- Portrait Google Photos settings
- Personal Photo curation
- Slideshow speed

9.8.8 Power and Energy

Power-on behaviour: Choose to startup your TV with Google TV home screen or your last used input.

Power & Energy: Adjust time of inactivity, after which the TV turn off itself automatically.

Power:

- **Sleep time:** Define an idle time after which you want your TV to enter sleep mode automatically.
- **Picture off:** Select this option and press OK to turn the screen off. Press a button on the remote or on the TV to turn the screen on again. Note that you cannot turn the screen on via the Volume +/-, Mute and Standby buttons. These buttons will function normally.
- **Switch off Timer:** Define a time after which you want your TV to switch off automatically. Set as Off to disable.
- **Auto sleep:** Here you can set when your TV set automatically switches to standby mode after a certain period of inactivity.

Timer:

- **Power On Time Type:** Set your TV to turn on by itself. Set this option as On or Once to enable a power on timer to be set, set as Off to disable. If set as Once the TV will turn on only once at the defined time in Auto Power On Time option below.
- **Auto Power On Time:** Available if the Power On Time Type is enabled. Set the desired time for your TV to come on from standby using the directional buttons and press OK to save the new set time.
- **Power Off Time Type:** Set your TV to turn off by itself. Set this option as On or Once to enable a power off timer to be set, set as Off to disable. If set as Once the TV will turn off only once at the defined time in Auto Power Off Time option below.
- **Auto Power Off Time:** Available if the Power Off Time Type is enabled. Set the desired time for your TV to go to standby using the directional buttons and press OK to save the new set time.

9.8.9 Cast

Remote Control notification

When running the Chromecast function from the mobile device that is in the same network as your TV, your TV will be recognised as a Google Cast device and allows the Google Assistant and other services to wake up your TV and respond to connected Chromecast devices. It will be possible to stream content or local multimedia content from your mobile devices to your TV.

Select your preference for Chromecast availability. You have three setting options:

- **Always** - your TV will always be visible to other devices that support this feature (even if it is in standby mode and the screen is switched off)
- **While casting** - Your TV will always be visible only while running the Chromecast function.
- **Never** - Your TV will not be visible to other devices.

9.8.10 Google

In this Menu option you can check whether system service updates are available.

9.8.11 System sounds

In this menu option you can activate or deactivate the system sounds.

9.8.12 Shop Mode

In this menu option you can activate or deactivate Retail (Shop) mode of TV.

9.8.13 Restart

Activate this Menu option to restart the TV.

9.9 Remote and accessories

This menu chapter explains how you can connect Bluetooth devices such as a soundbar, headphones, Bluetooth speakers, mouse & keyboard, or game controller to your TV.

Bluetooth Enable / Disable: Here you can activate or deactivate the Bluetooth function of your TV.

Pair accessory:

- Set the device you want to connect to the TV to pairing mode.
- Select the "Pair accessory" Menu option and press the OK button on the remote control to start the search for Bluetooth devices in pairing mode.
- The available devices will be recognised and displayed in a list.
- Select the desired device from the list and press OK to start the pairing process with the TV.

Accessories:

- When the pairing process is completed, Bluetooth connected devices will be listed in under accessories.

9.10 Help & Feedback

Please visit the Google support website to send feedback or request support.

10 Source & Shortcuts & Recent direct access Menu

Press the **Source** button on the remote control to display the **Direct Access** Menu.

In this menu, you can choose your live TV signal source, access various TV functions directly, or quickly open recently used applications.

Settings:

Select this menu option to select or move direct access items.

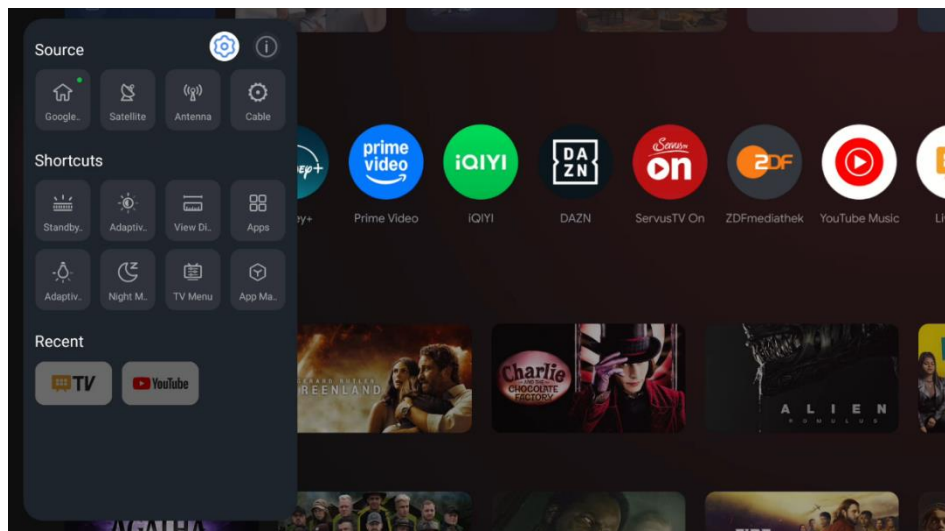

Source:

Select to the Source selection or move the Signal source icon such as Google TV, Satellite, Antenna, Cable or one of the assigned HDMI inputs.

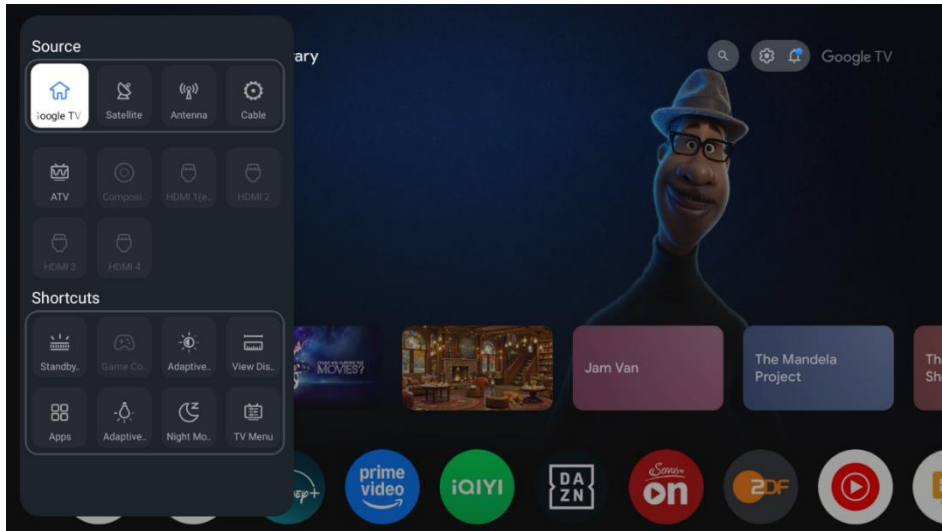

Shortcuts:

Select to the Shortcuts selection or move the Shortcut function icon such as TV Menu, Standby light bar or Apps or others.

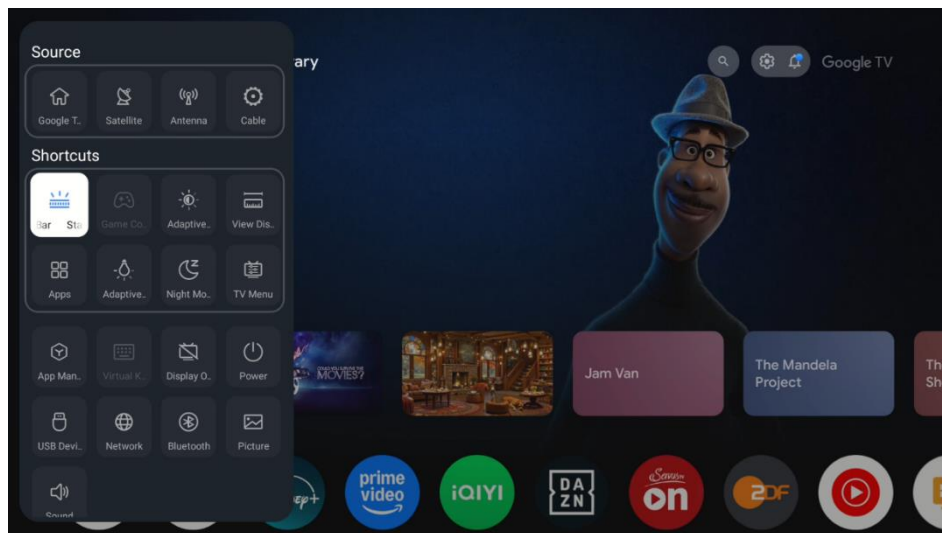

Info:

Select this Menu option to activate or deactivate the description of the selected function.

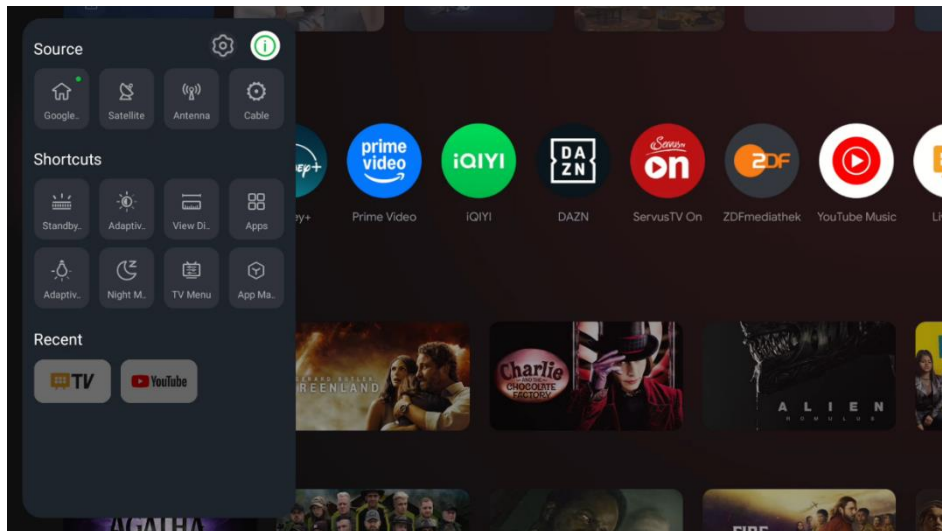

Shortcuts:

Here you can directly access selected menu functions.

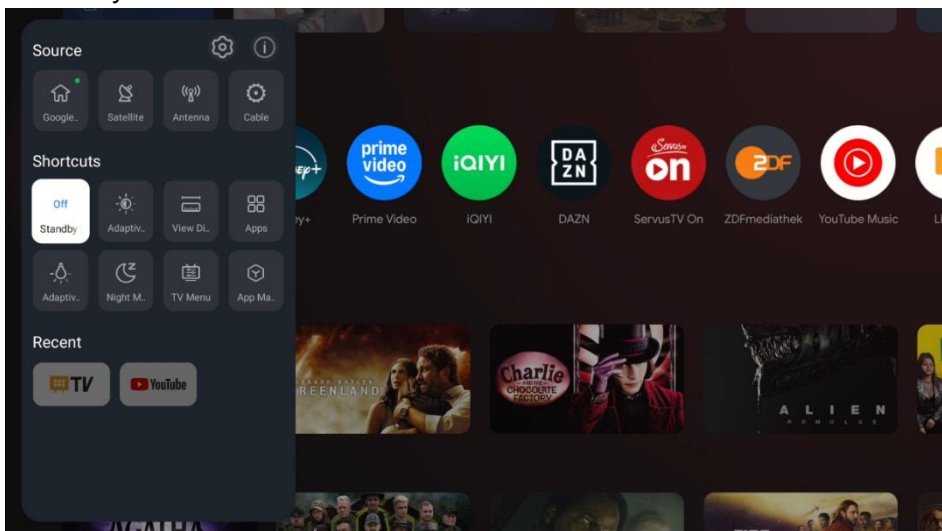

Recent:

Here you can launch the Application that was recently active.

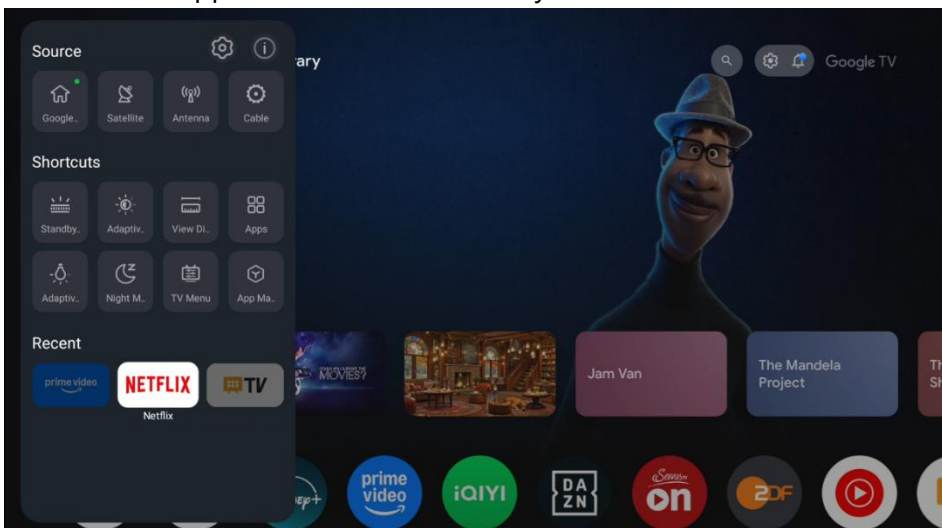

11 Multimedia Player

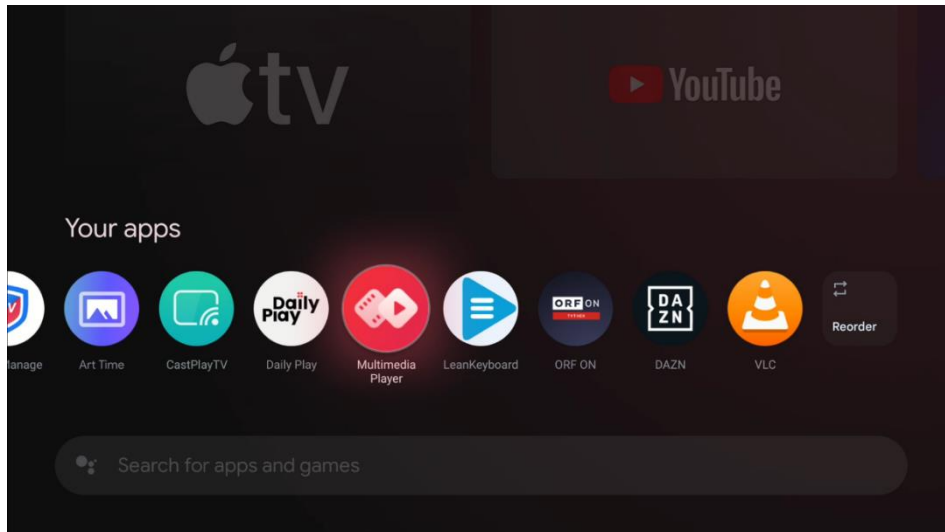

Playback of multimedia data from external storage devices

Plug the USB storage device into one of the USB inputs on the TV to view your photos, play your music, and video files stored on the connected USB storage device.

To begin, start the MMP application from your Home screen and select the desired media type.

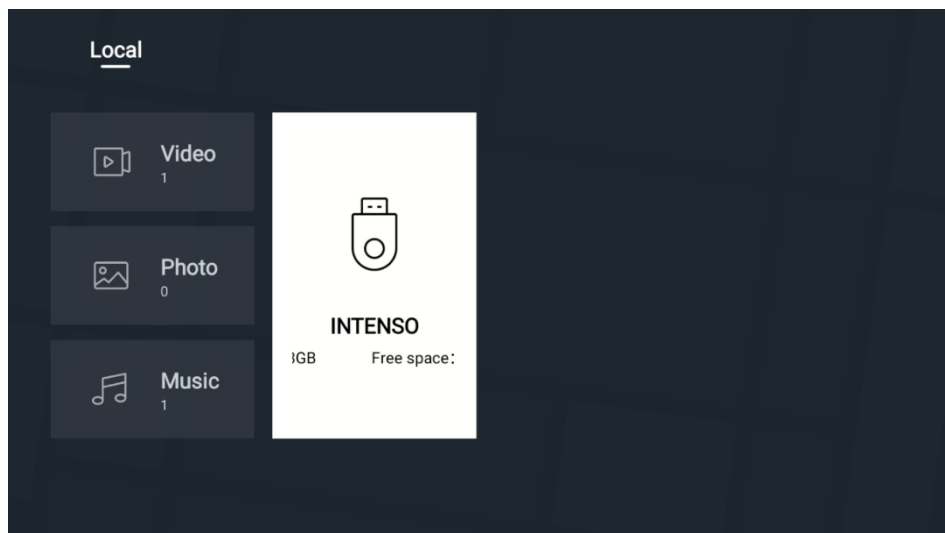

On the next screen, highlight a file name from the list of available media files and press the OK button. Follow the on-screen instructions for more information on other available button functions.

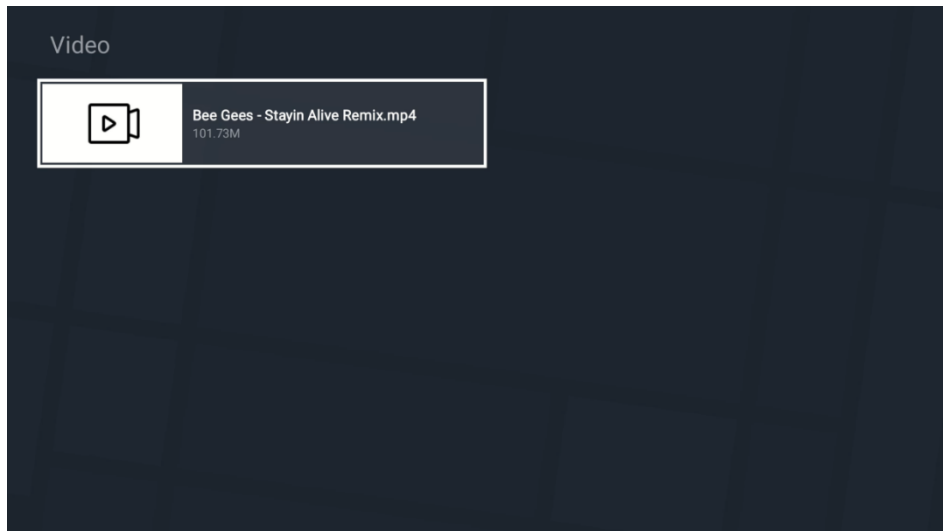

To play multimedia files from external USB storage devices, you can also use any of the multimedia players available for download in the Google Play store.

Note:

- Depending on the storage capacity of your connected USB device, it may take several seconds before your files are listed. Do not remove your drive while playing a file.
- Storage capacities larger than 2 TB are not supported.
- External storage media formatted in FAT32 or NTFS file systems will be recognized by the TV. Storage media formatted in exFAT format must first be formatted in NTFS on a PC and then connected to the USB port of the TV.

12Live TV Settings

Select the Live TV app on the Home screen and press the OK button to launch it.

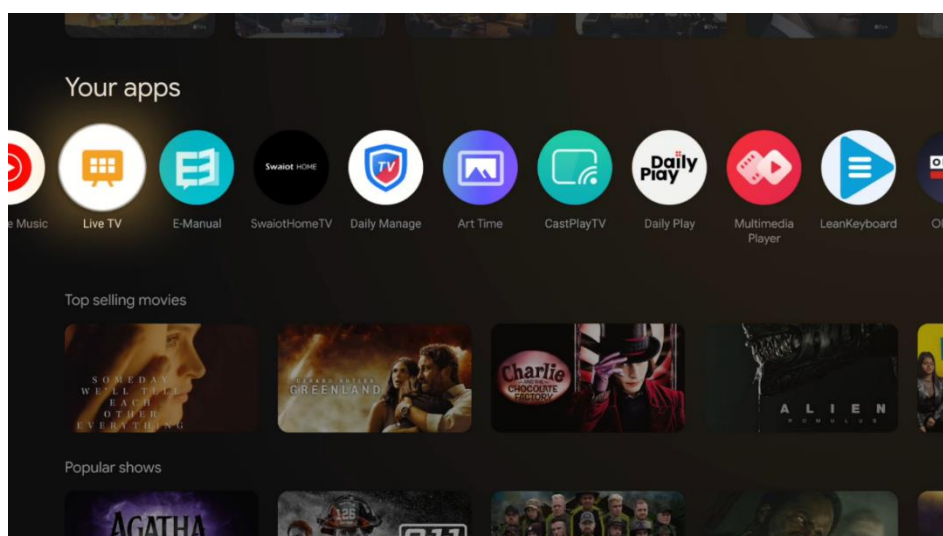

If you have not installed the Live TV broadcast channels in the initial installation process, you can do this subsequently in the following menu steps:

- Go to the Home Screen, then navigate to the top right corner and press (icon) Settings icon.
- In Live TV app press (icon) Settings button on your remote control, in the TV options submenu navigate to Settings and press "OK".

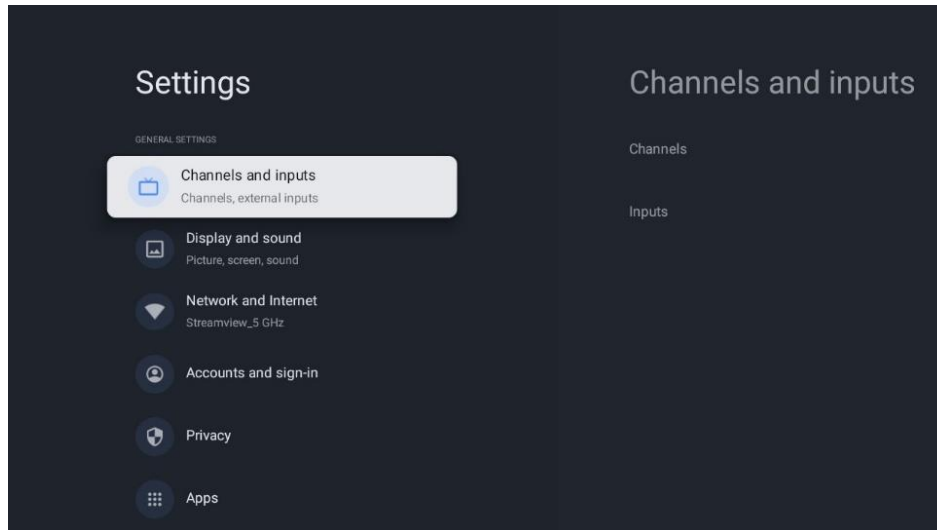

Refer to 9.2 Chapter- Channels and Inputs to proceed with channels installation.

13Live TV App

Please launch the Live TV app from the Home screen of your TV.

Press Source button on RCU to open the direct access Menu. Please select the "TV Menu" in the Shortcuts selection. The Menu options "Channels", "TV options" and "Record" will be available on the TV screen. Press the Up or Down button on the remote control to access one of these three main Menu options.

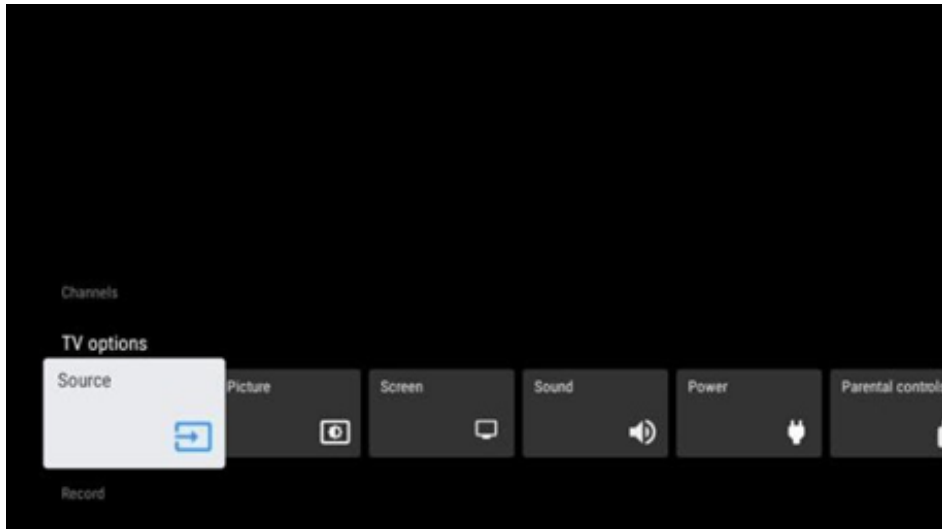

13.1 Channels Menu

13.1.1 Programme Guide (EPG)

Experience the convenience of the Electronic Programme Guide (EPG) feature on your TV, enabling you to effortlessly browse the schedule of channels currently available in your channel list. Please note, the availability of this function depends on the programme.

To access the electronic programme guide while in Live TV mode, simply select this corresponding menu option or press the EPG button (icon) on your remote control. To return to Live TV, press the "Back" button (icon) on your remote control.

Navigate through the programme guide using the directional buttons on your remote control. Utilize the Up/Down directional buttons or the Programme +/- buttons to browse through channels, and the Right/Left directional buttons to select a desired event on the highlighted channel. Detailed information such as the full event name, start and end time, date, genre, and a brief description will be displayed at the bottom of the screen if available.

Easily filter events by pressing the blue button on your remote control, offering a variety of filter options to quickly locate events of your preferred type. For more information about a highlighted event, press the yellow button to display detailed information.

To view events from the previous or next day, simply press the red or green buttons respectively. These functions are assigned to the coloured buttons on your remote control when available. Refer to the on-screen instructions for the specific functions of each button.

Please note that the guide will not be accessible if the TV input source is locked in the Settings > Channel > Parental Controls > Locked Inputs menu either in Live TV mode or on the home screen.

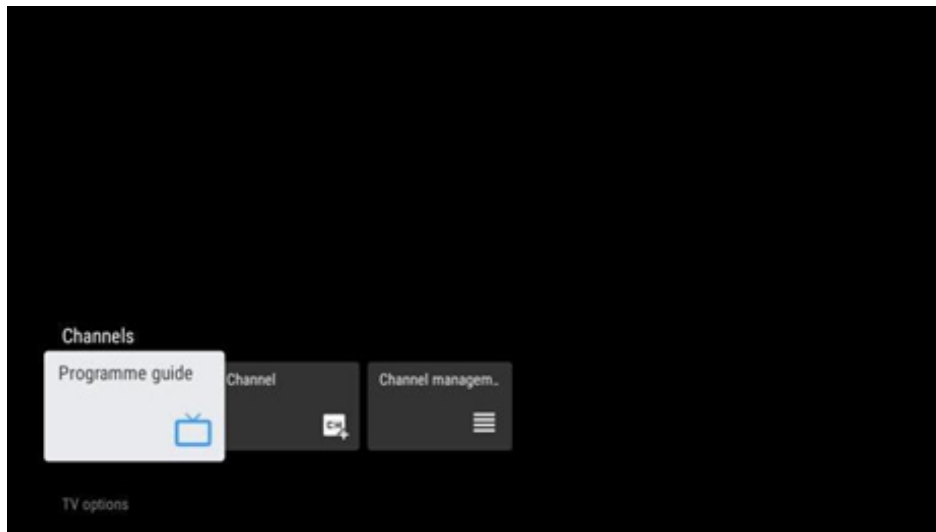

13.1.2 Channel

Select the Live TV signal reception type to which your TV is connected.

13.1.3 Channel Management

- Launch Live TV app
- Press "OK" to open Channel list
- Press Red Dot button to open Channel management

13.1.3.1 Channel Management for Satellite reception

Preferred Satellite Installation option:

If you selected the Preferred Satellite installation option when setting up satellite channels, the channels will be organized based on the LCN (Logical Channel Number) regulation of the chosen operator. As a result, you'll only have two options for editing the channel list:

1. **Channel Re-sort:** This option reorders channels according to the LCN regulation of the selected operator.
2. **Clear Channel List:** This option deletes all installed TV channels.

These are the only available options because the Preferred Satellite - Operator scan strictly adheres to a specific channel order set by the operator.

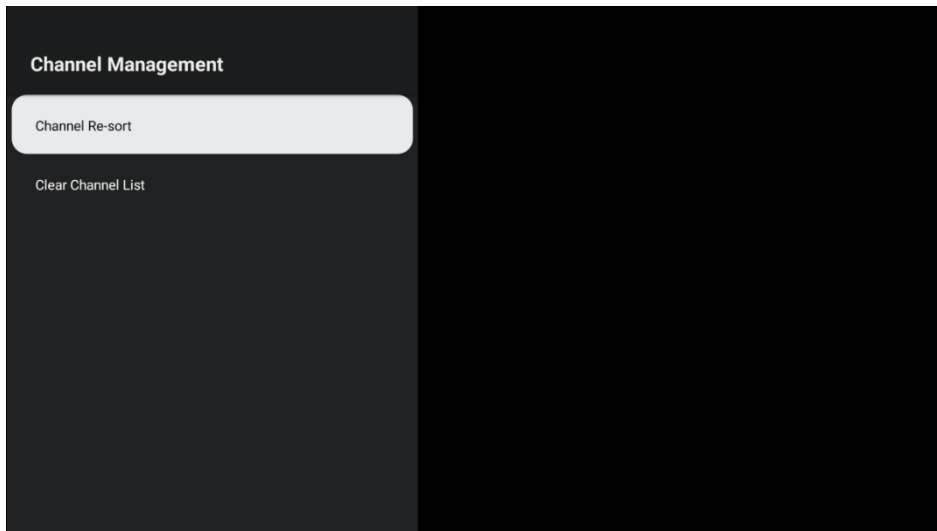

General Satellite Installation option:

If you chose the General satellite installation option when setting up satellite channels, you'll have access to all channel list editing options, as this list is not restricted by LCN (Logical Channel Numbering) rules.

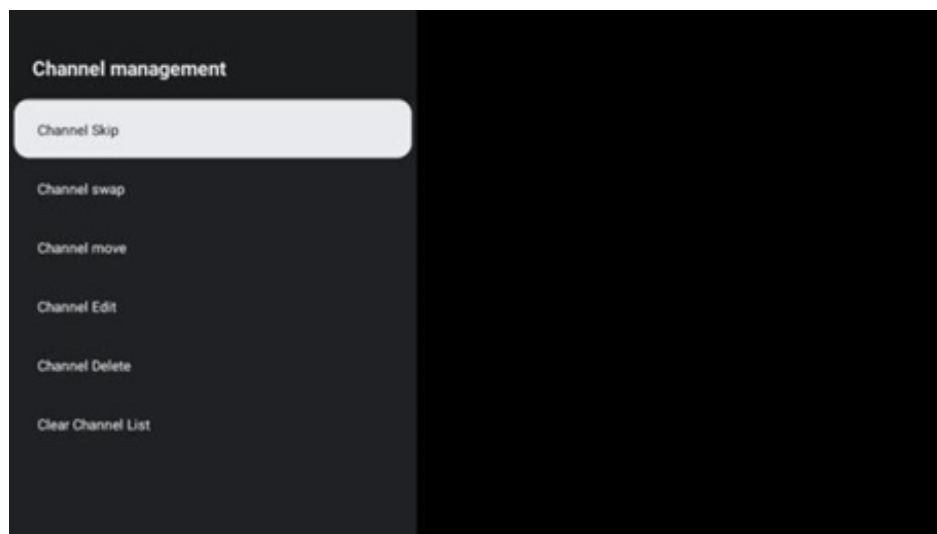

- Open LiveTV app
- Press "OK" to open Channel list
- Press Red Dot button to open Channel management

Follow the following steps to edit the channels individually:

Channel SKIP

Once a channel is set to be skipped, it will no longer appear in the channel list or program guide, even after restarting the TV, but the channel is not deleted.

- Select Channel Skip option
- Select the channels which you want to SKIP

Channel SWAP

Allows you to switch the position of channels in the channel list.

- Select Channel Swap option
- Select the channel which you want to SWAP (for example, channel 1).
- Move the selection to the number where you want the channel to be swapped (for example, channel 16).
- Confirm by pressing "OK" button

Channel MOVE

Allows you to rearrange the position of channels in the channel list.

- Select Channel Move option
- To change the channel position, select the channel that you want to MOVE (for example, channel 1)
- Move the selection to the number where you want the channel to be moved to (for example, channel 5)
- After selecting the position, press the Blue Dot button on your remote - a Warning message will appear
- Select YES and press OK on your remote. The channel will be moved to the desired position.

Channel EDIT

Allows you to customize and manage the channels stored on your TV.

- Select Channel EDIT option
- Select the channel that you want to EDIT (for example, channel 1).
- Now you have option to edit the number of the channel and the channel name.

Channel DELETE

Allows users to remove unwanted channels from their channel list. Note that to return deleted channels, you will have to perform channel scan.

- Select Channel Delete option
- Select the channel that you want to Delete (for example, channel 5).
- After selecting the channel, press the Blue Dot button on your remote - a Warning message will appear.
- Select YES and press OK on your remote. The channel will be deleted from the list.

Channel RE-SORT

Reorders the whole channel list. If there is Logical Channel Number (LCN) from your provider, then the channels will be reordered according to LCN.

Clear Channel List

Clear the whole channel list. When complete, you will have to scan for channels again. To check how to do it, please, refer to 9.1.1.

Channel Management for **Antenna** reception

The same Channel Management options as for the General satellite channel list are available for the channels installed in Antenna reception. Please read this chapter.

13.1.3.2 Channel Management for Cable reception

Cable: Operator scan

The channel list generated in the **Operator** scan has limited channel editing options due to LCN rule.

Cable: Full scan

The channel list generated in the **Full** scan has the same channel editing options as General scan option in Satellite scan.

13.1.3.3 Channel Management for Antenna reception

Antenna: Operator scan

The channel list generated in the operator scan has limited channel editing options due to LCN rule.

Antenna: Automatically scan

The channel list generated in the operator scan has the same channel editing options as General scan option in Satellite scan. Please make sure that LCN is deactivated.

13.1.4 Channel List options

To open Channel list, open Live TV and press "OK". You will be able to see the channel list defined by LCN, if this option is enabled.

Some options in the Channel list:

You can select "Channel management", "Channel operation", "Select Type" and "Add favourite" by pressing the coloured dot button on your remote control

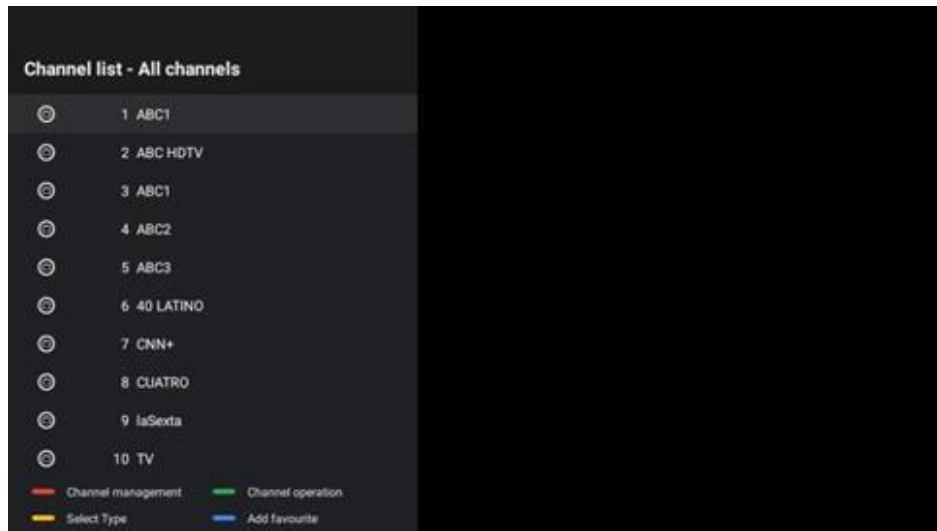

13.1.4.1 Channel operation

There are "Sort" and "Find" in the "Channel operation" by pressing "green dot" button.

You can select your preferred way to sort, by selecting "Sort" and then pressing "OK".

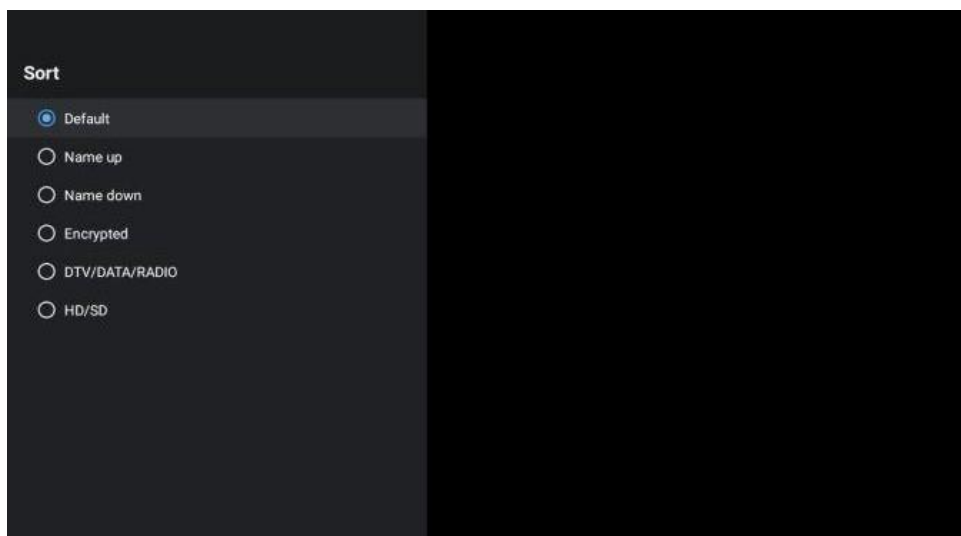

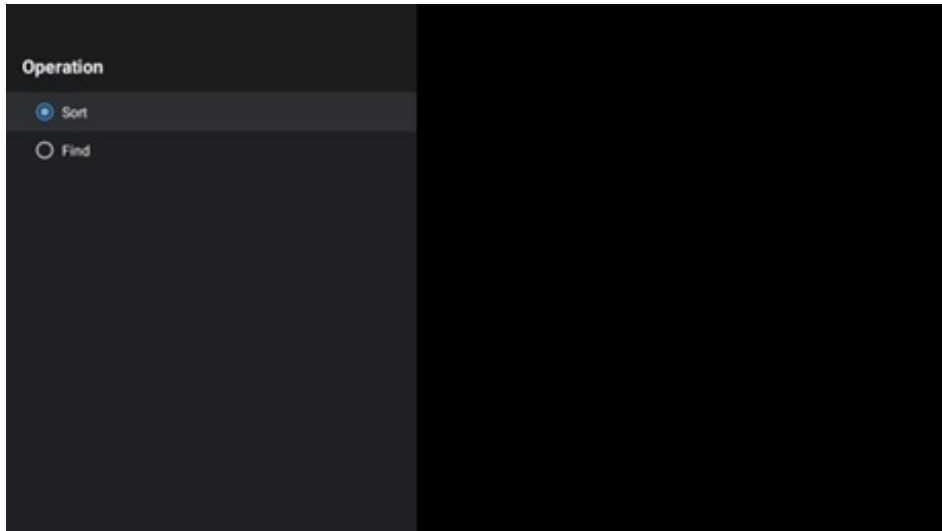

13.1.4.2 Select Type:

You can decide what type of media to show in LiveTV. In the Channel list press “yellow dot”.

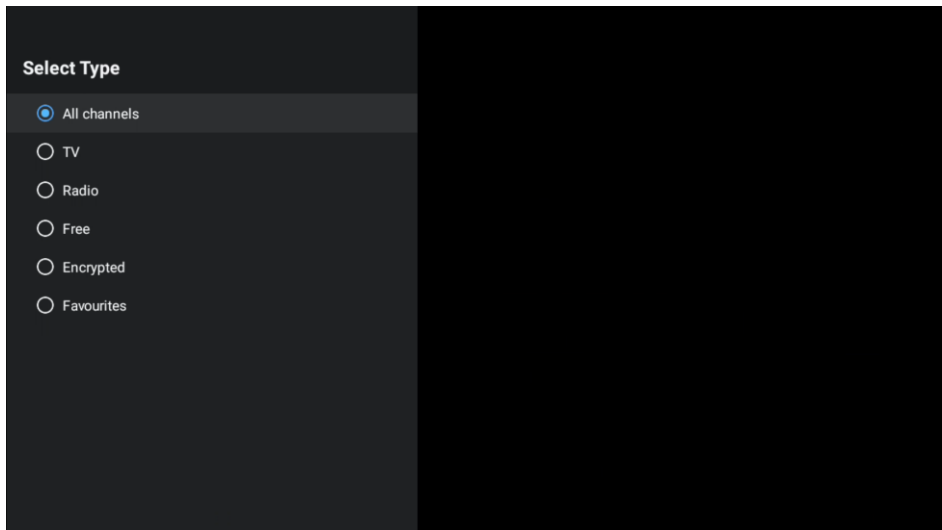

13.1.4.3 Add Favorite

Add channels to the favourite lists. The TV has the option of 4 favourite lists. When you add your favourite channels to the list, go to Select type and select “Favourites”. Then select the list of favourite channels, which you want to watch.

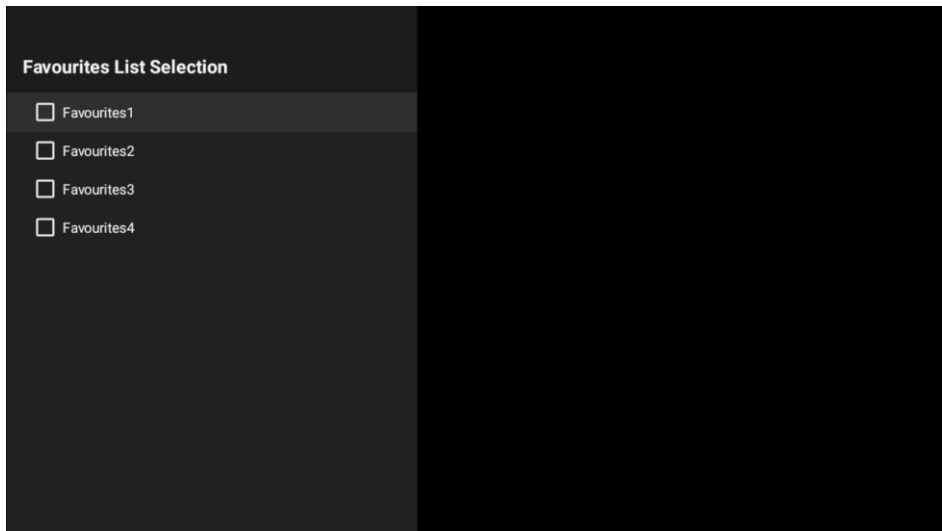

13.2 TV Options

"Source", "Picture", "Screen", "Sound", "Power", "Parental controls", "CI Card", "Advanced Options" and "Settings" are in TV Options.

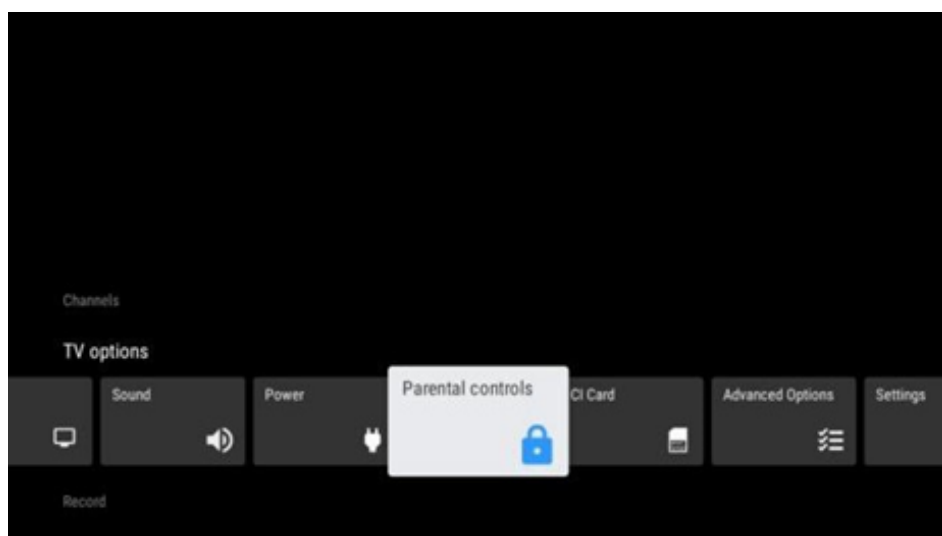

13.2.1 Source

Display the list of available input sources. Select the desired one and press OK to switch to that source.

13.2.2 Picture

Opens picture settings. How to adjust these settings, refer to 9.3.1.

13.2.3 Screen

Opens screen aspect ratio adjustments. Adjust these settings for your comfortable watching.

13.2.4 Sound

Opens sound settings. How to adjust these settings, refer to 9.3.2.

13.2.5 Power

Opens power and energy settings. How to adjust these settings, refer to 9.8.8.

13.2.6 Parental controls

This menu allows you to configure parental control options. To access it, you'll need to enter the PIN code you set during the initial TV setup process.

13.2.7 CI Card

In this menu, the available menu options of the connected CI cam/card will be indicated.

13.2.8 Advanced Options

- **Audio:** Allows you to adjust audio preferences such as audio language, second audio language, soundtrack settings and audio type. Selecting the preferred audio language is particularly important for TV channels that broadcast in several languages.
- **Subtitle:**
 - Analogue Subtitle: Set this option as Off, On or Mute. If Mute option is selected, the analogue subtitle will be displayed on the screen but the speakers will be muted simultaneously.
 - Digital Subtitle: Set this option as Off or On.
 - Subtitle Tracks: Set your subtitle track preference, if any available.
 - Digital Subtitle Language: Set one of the listed language options as first digital subtitle language preference.
 - Second Digital Subtitle Language: Set one of the listed language options as second digital subtitle language preference. If the selected language in the Digital Subtitle Language option is not available, the subtitles will be displayed in this language.
 - Subtitle Type: Set this option as Normal or Hearing Impaired. If Hearing Impaired option is selected, it provides subtitle services to deaf and hard of hearing viewers with additional descriptions.
- **Teletext:**
 - Digital Teletext Language: Set the teletext language for digital broadcasts.

- Decoding Page Language: Set the decoding page language for teletext display.
- **Blue Mute:** The "Blue Mute" function on a TV is a feature that changes the screen colour to blue when there is no signal detected on a particular input or channel.
- **No signal auto power off:** Set the time after which the TV goes into Standby mode, provided there is no signal.
- **Default channel:** Set your default startup channel preference. When the Select Mode is set as User Select, Show Channels option will become available. Highlight and press OK to see channel list. Highlight a channel and press OK to make a selection. Selected channel will be displayed, every time the TV is turned back on from quick standby mode. If the Select Mode is set as Last Status, the last watched channel will be displayed.
- **HBBTV Settings:** Allows you to enable or disable HBBTV support, choose tracking options, adjust cookie settings, adjust device ID settings.
- **System information:** Display detailed system information on the current channel such as Signal Level, Signal Quality, Frequency etc.
- **Open-source licences:** Showcases all the information regarding licences.

13.2.9 Settings

The Settings Menu is explained in detail in Menu chapter 9 of this User Manual.

13.3 Record

Note:

To be able to record your favorite channels and shows, you must activate the "Record" option, as it is not available by default.

You can activate this option via activation code. You can pay for and download the activation code and instructions on how to activate the recording function on the Products & Downloads section on our website: <https://tv.mythomson.com/en/Products/Accessories-Downloads/>

Connect an external storage device such as a USB stick or HDD/SSD to one of the TV's USB ports. Please note that the USB stick or HDD/SSD should have at least 32 GB for convenient recording. Then launch the **Live TV** app. Press the **Settings** button on your remote control, navigate to the **Record** submenu and select the menu option "**Device info**". Select the connected USB device intended for recording and press the OK button. Select the Format menu option and press the **OK** button. Please, confirm your selection in the dialogue window that appears.

Your USB stick or HDD/SSD will be prepared for the record function.

13.3.1 Start recording

Select this Menu option to start direct recording. To stop recording, select this Menu option again and confirm your selection with the OK button.

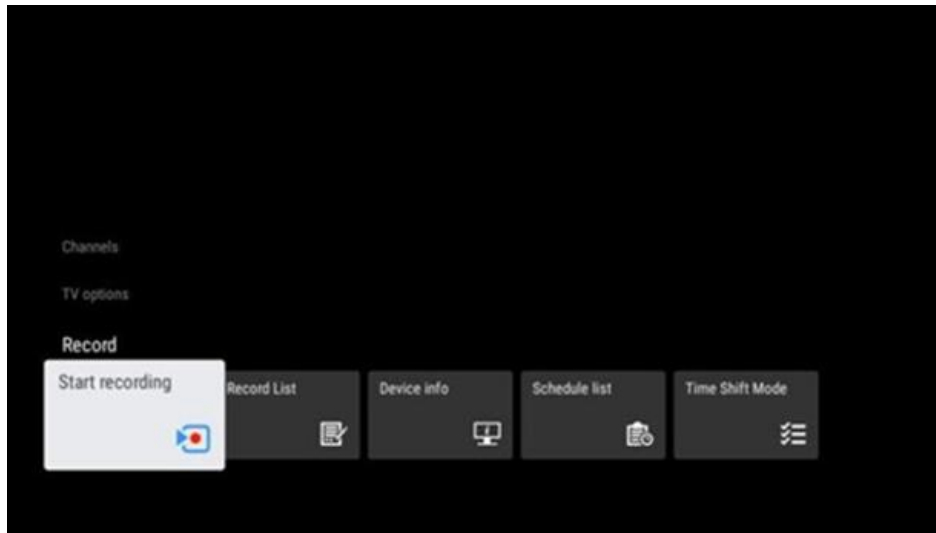

You can also start direct recording or **Time Shift** recording via the **Virtual keyboard**. To launch the **Virtual keyboard**, press the **Source** button on the remote control and then select the **Virtual keyboard** icon in the "**Shortcuts**" area and confirm your selection with the **OK** button.

Note:

You can also launch the Virtual Keyboard by configuring the "Daily key" button on the remote control. You can configure the "Daily" button in "Multi function" mode or "Single function" mode. For example, in "Multi function" mode, you can configure one of the Direction buttons to launch the Live TV Menu and the other to launch the Virtual Keyboard. Or in "Single function" mode, you can configure the "Daily key" button to launch the Virtual Keyboard directly.

The functionality of the Daily key button is explained in the **Menu chapter 12**.

13.3.2 Record List

The recorded programmes will be displayed in this submenu. Highlight a recording and press the yellow button to delete it or press the blue button to display detailed information. Use the red and green buttons to scroll up and down the page.

13.3.3 Device Info

Connected USB storage devices will be displayed. Highlight the device of your choice and press OK to see available options.

- **Set Time Shift:** Tag the selected USB storage device or a partition on it for time shift recording.
- **Set PVR:** Tag the selected USB storage device or a partition on it for PVR.
- **Format:** Format the selected USB storage device. Refer to USB Recording section for more information.
- **Speed Test:** Start a speed test for the selected USB storage device. The test result will be displayed when completed.

13.3.4 Schedule List

You can add reminders or recording timers via the Schedule list menu. Highlight Schedule list and press OK. Previously set timers are listed if they are available.

Select "Add" in the dialogue window to add a timer recording. The "Schedule list" menu is displayed on the screen. You can specify the type of timer by setting the Schedule type option as Reminder or Recording. If other parameters are set, press "Green" button on your remote control. The timer is added to the list.

If available, you can also edit or delete the timers in this list. Highlight the timer of your choice and press one of the coloured buttons displayed at the bottom to edit, add or delete. Once you have edited a timer, the dialogue window will be displayed to replace the overlapped timer. If you want to delete a timer, a confirmation dialogue will be displayed on the screen. Highlight Yes and press OK to delete the selected timer.

If the time intervals of two timers overlap, a warning message is displayed. You cannot set more than one timer for the same time interval.

Press the "Back" button to close the schedule list.

13.3.5 Time Shift Mode

In time shift recording mode, the programme is paused on the TV screen and simultaneously recorded in the background on the connected USB storage medium. The time shift recording function must first be activated in Menu / Record / Time Shift Mode / OK.

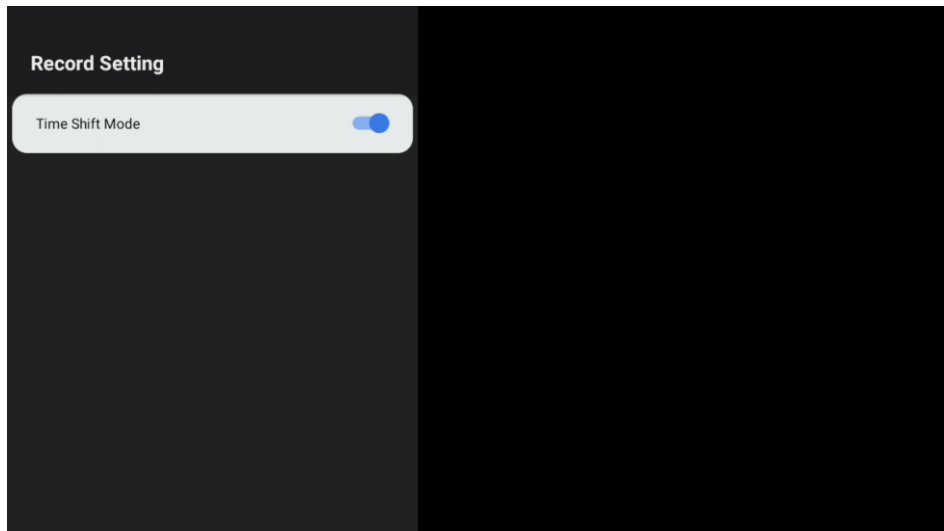

To activate Time shift recording while watching a programme in live TV mode, press and hold the Menu button. The virtual keyboard will be displayed on the screen.

- Select the Pause icon and press OK to start the time shift recording.
- Select the Play icon and press the OK button to resume playback from the point where you started the time shift recording.
- Select the Stop symbol to end the Time shift recording and continue with the TV broadcast in real time.

Note: When you use the Time Shift function for the first time, a configuration dialogue for the hard disk setup is displayed on the TV screen. Select the configuration options offered and follow the steps in the Time Shift configuration menu. You can select either automatic or manual setup mode. In manual mode, you can format your USB storage device if you wish and specify the storage location to be used for Time Shift recordings.

The Time Shift recording function is not available for radio programmes.

14 Daily Key Button Function

The Daily Key button allows you to directly access installed applications or functions on your TV device.

To configure the function of the "Daily button" on the remote control, please start the "Daily button" application on the TV Home screen.

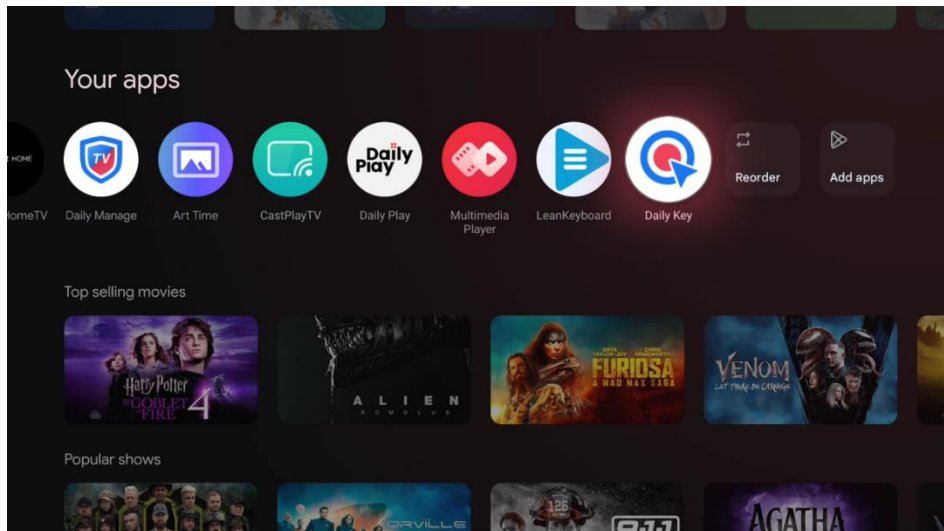

You have two configuration options available:

Multi-function:

With this type of configuration, you can assign various applications or functions to each of the directional buttons. Select one of the "+" icons and then choose an installed application or system function that you want to assign to that button.

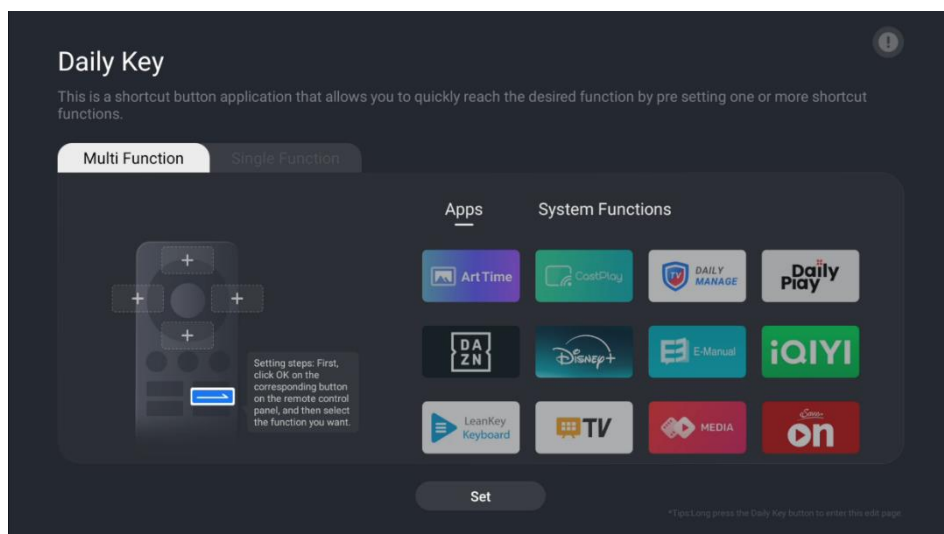

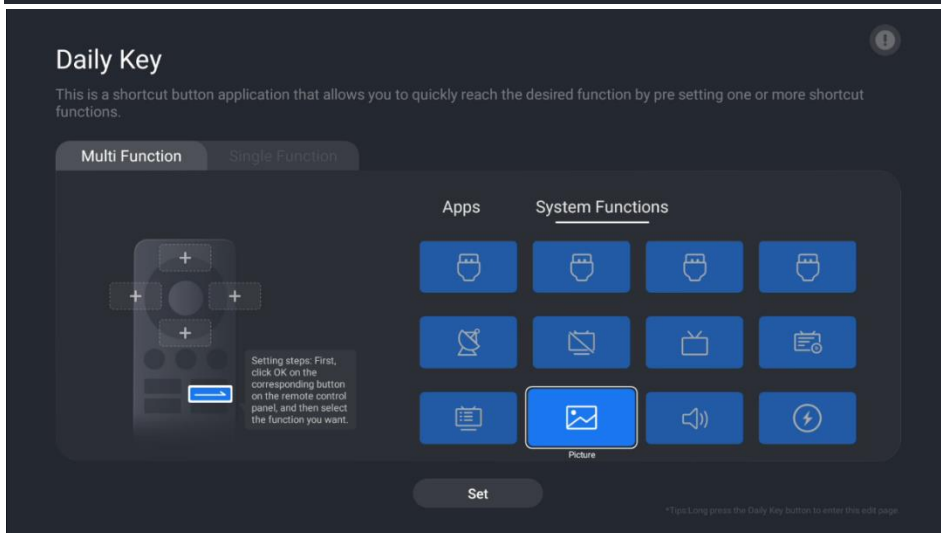
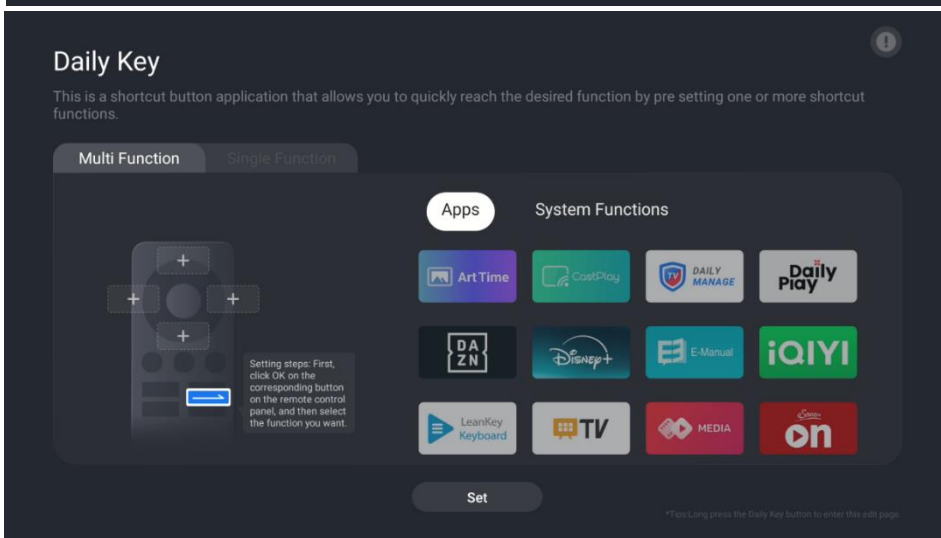
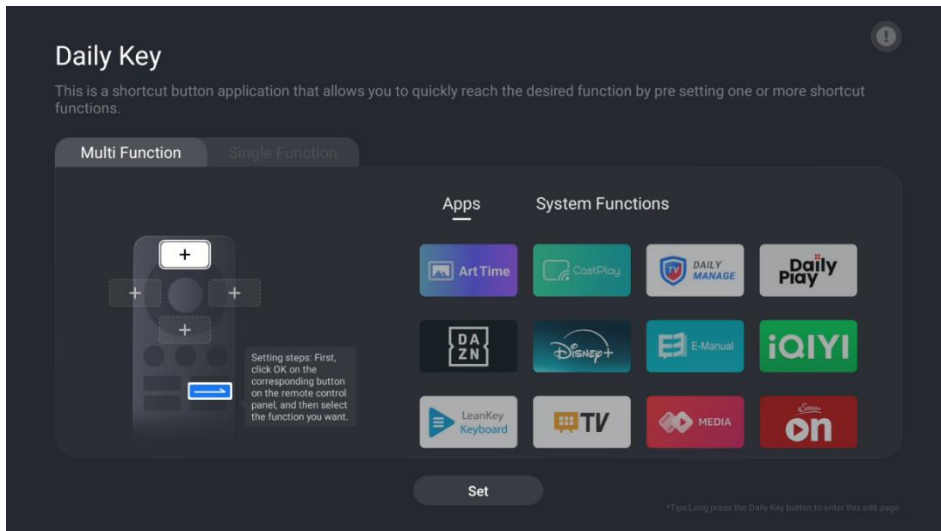

Once you have configured the Direct Access button function, press the **Daily Key** button on your remote control to launch the assigned application or function. A graphical representation of your remote control will appear in the lower left corner of the screen. Press the corresponding configured **Directional button** to launch the desired application or function.



Single Function

With this configuration method, only one application or system function will be set for direct access using the Daily Key button. The configuration process for this function is the same as that of the Multi-function configuration process.

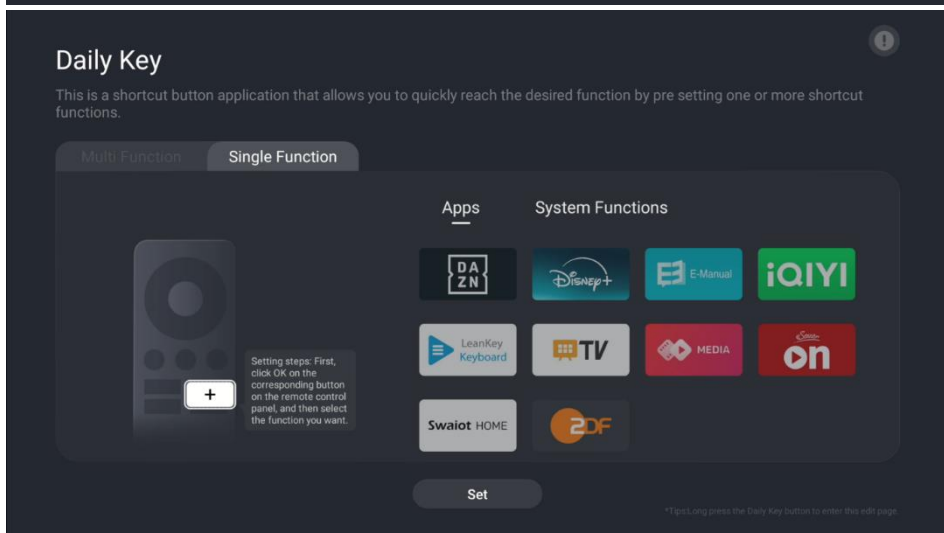
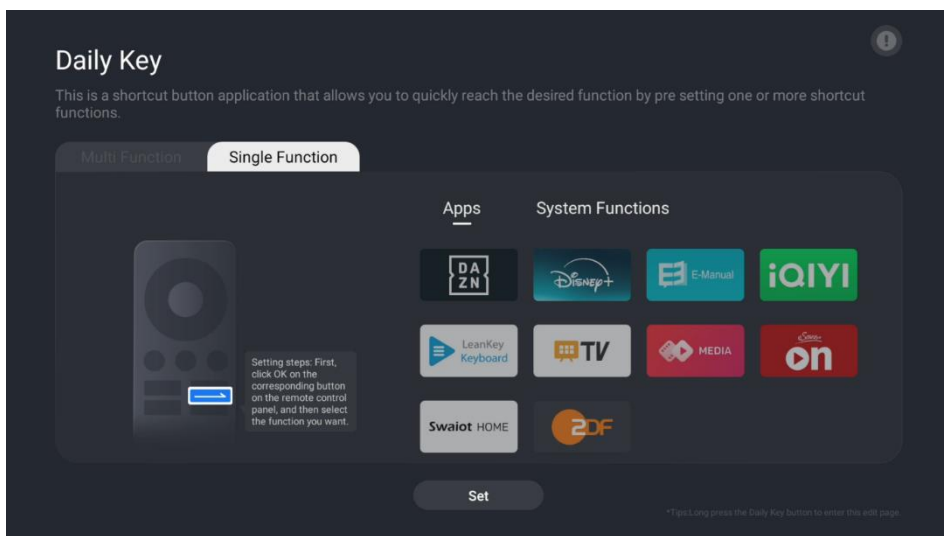

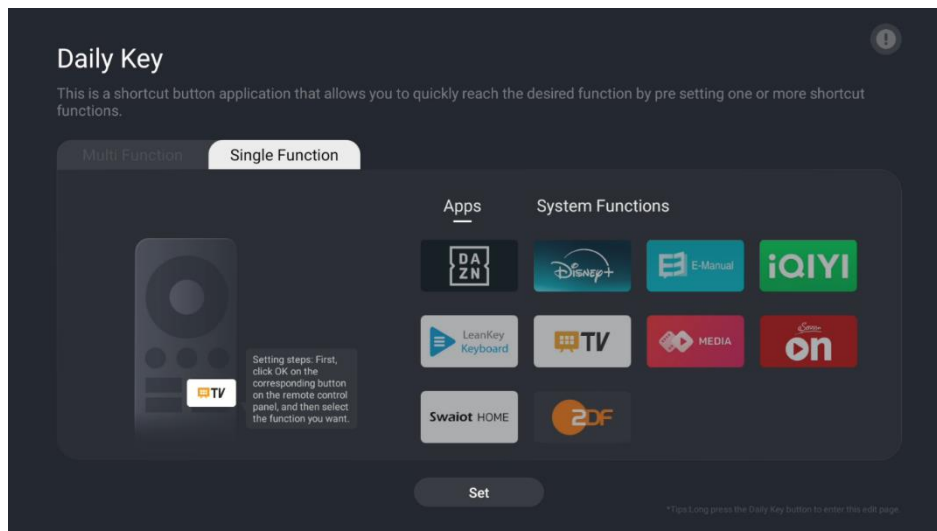

When you are finished with the configuration, you can press the Daily key button on remote control to launch the desired application or function.

15 Troubleshooting

No power	Check if the AC power cord of your TV is plugged in or not. If there is still no power, please disconnect the plug and reconnect to the socket after 60 seconds. Turn the power back on.
No picture	Check if the antenna cable at the back is connected properly. View other channels to see if the problem still occurs.
Video appears with no audio	Try to increase the volume. Check if the TV's sound is on mute or not.
Remote doesn't work	Make sure the plastic bag which came with the remote control is removed. Try using the remote in a shorter distance from the TV. Check if the placement of the batteries is correct or try using new batteries with the remote control. The TV will go into Standby mode if it receives no response within a few minutes.
Problems are unresolved	Unplug the power cable and wait for 30 seconds, then reconnect power cable to the socket. If the problems still exist, do not attempt to repair the TV by yourself. Kindly contact the service center.

16 Technical specifications

	55OG8S24	65OG8S24	77OG8S24
Operating Voltage	AC 100-240V 50/60Hz	AC 100-240V 50/60Hz	AC 100-240V 50/60Hz
Audio Output Power	2x12 + 20 + 5x2	2x12 + 20 + 5x2	2x15 + 25 + 5x2
Power Consumption (W)	85	110	160
Networked Standby Power Consumption (W)	0,5	0,5	0,5

Weight with stand (Kg)	19.7	24	36.6
TV Dimensions LxWxH (with stand) (mm)	1226x256x752	1447x326x882	1723x377x1040
TV Dimensions LxWxH (without stand) (mm)	1226x53x711	1447x56x835	1723x63x997
Display	55" / 139cm	65" / 164cm	77" / 195cm
Screen resolution	3840 x 2160	3840 x 2160	3840 x 2160

16.1 Country restrictions

Intended for indoor use only in EU member states and EFTA states.

AT	BE	BG	CH	CY	CZ	DE	DK	EE	ES	FI	FR
GR	HR	HU	IE	IS	IT	LI	LT	LU	LV	MT	NL
NO	PL	PT	RO	SI	SK	SE	TR	UK	(NI)		

16.2 Licenses

Subject to alterations. In consequence of continuous research and development technical specifications, design and appearance of products may change. Google TV is the name of this device's software experience and a trademark of Google LLC. Google, YouTube, Google cast built-in and YouTube Music are trademarks of Google LLC. Google Assistant is not available in certain languages and countries. Availability of services varies by country and language. Netflix is a registered trademark of Netflix, Inc. Netflix streaming membership required. 4K Ultra HD availability subject to your Netflix subscription plan, Internet service, device capabilities, and content availability. www.netflix.com/TermsOfUse (La disponibilité de la 4K Ultra HD dépend de votre forfait Netflix, de votre connexion Internet, des capacités de l'appareil et de la disponibilité du contenu. www.netflix.com/TermsOfUse). Disney+ subscription required, see terms at <https://www.disneyplus.com>. ©2024 Disney and its related entities. ©2024 Amazon.com, Inc. or its affiliates. Amazon, Prime Video, and all related marks are trademarks of Amazon.com, Inc. or its affiliates. Amazon Prime membership or Prime Video fees apply. See primevideo.com/terms for details. Wi-Fi is a registered trademark of Wi-Fi Alliance®. The terms HDMI and HDMI High-Definition Multimedia Interface, and the HDMI logo are trademarks or registered marks of HDMI Licensing Administrator, Inc. in the United States and other countries. Dolby, Dolby Vision, Dolby Atmos and the double-D symbol are registered trademarks of Dolby Laboratories Licensing Corporation. Dolby Vision IQ is a trademark of Dolby Laboratories Licensing Corporation. Manufactured under license from Dolby Laboratories. Confidential unpublished works. Copyright © 2019–2024 Dolby Laboratories. All rights reserved. All product names are trademarks or registered trademarks of their respective owners. ©2024 StreamView GmbH, Franz-Josefs-Kai 1, 1010 Vienna, Austria. This product has been manufactured and sold under the responsibility of StreamView GmbH. THOMSON, and the THOMSON logo are trademarks used under license by StreamView GmbH – further information at www.thomson-brand.com.