

# THOMSON

---

## Thomson Go Plus

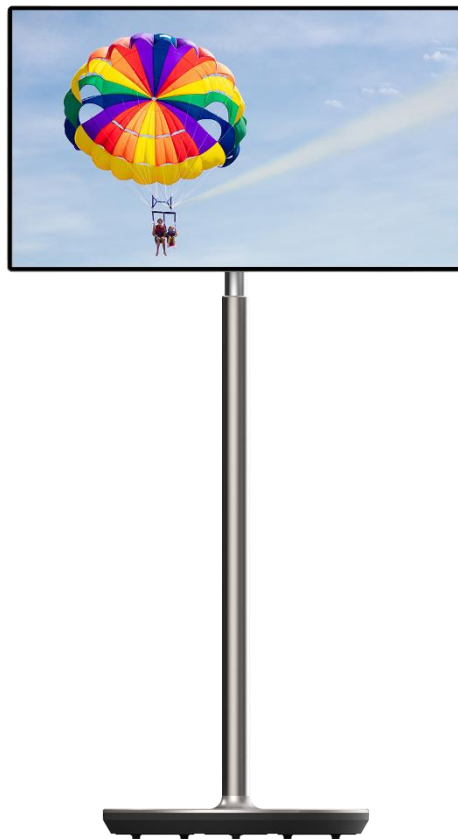

[tv.mythomson.com](https://tv.mythomson.com)



[tv.mythomson.com/  
en/Support/FAQs/](https://tv.mythomson.com/en/Support/FAQs/)

# IMPORTANT

Please read this manual carefully before installing and operating this device.  
Keep this manual handy for further reference.  
Pictures shown in this user manual are only schematic diagrams.

## Contents

- 1 Safety Information ..... 5
  - 1.1 Markings on the product..... 6
  - 1.2 Warning..... 6
- 2 Installation Instructions for Lifter and Smart Display..... 7
  - 2.1 Assembly of Lifter..... 7
  - 2.2 Assembly of Display Screen..... 8
  - 2.3 Disassemble the Lifter..... 9
  - 2.4 Adjustment of Angle and Height..... 9
- 3 Operation buttons and connections..... 10
  - 3.1 Connections..... 10
  - 3.2 Button Functions..... 11
    - 3.2.1 TV control buttons ..... 11
    - 3.2.2 Power supply connection and Power On/Off button on the TV stand ..... 11
  - 3.3 Use of Internal Battery..... 12
- 4 Initial Setup..... 13
  - 4.1 Select your Country ..... 13
  - 4.2 Vision Settings ..... 14
  - 4.3 Wi-Fi connection..... 15
  - 4.4 Copy apps & data..... 16
  - 4.5 Create user ..... 16
  - 4.6 Google account credentials..... 17
  - 4.7 Terms of Service and Privacy Policy ..... 17
  - 4.8 Google services ..... 18
  - 4.9 Create PIN ..... 18
  - 4.10 Activate "Hey Google" for Google Assistant..... 19
  - 4.11 Add a card to your Google Play..... 20
  - 4.12 Additional Settings..... 21

4.13	Remote control pairing .....	21
5	Remote Control and Touch Screen .....	23
5.1	Pairing Bluetooth Remote .....	23
6	Touch Screen Operation .....	25
7	Home Screen.....	27
8	Settings.....	30
8.1	Network & Internet.....	30
8.2	Connected devices .....	31
8.3	Apps.....	32
8.4	Notifications .....	32
8.5	Battery.....	33
8.6	Storage .....	34
8.7	Sound .....	34
8.8	Display .....	35
8.9	Wallpaper.....	35
8.10	Accessibility.....	36
8.11	Security.....	37
8.12	Privacy.....	38
8.13	Location.....	39
8.14	Safety & Emergency .....	39
8.15	Passwords & Accounts .....	40
8.16	Digital Wellbeing and Parental Controls.....	41
8.17	Google Services.....	42
8.18	System.....	43
8.18.1	Language & Input .....	43
8.18.2	Gestures .....	44
8.18.3	Date & Time .....	44
8.18.4	Backup .....	45
8.18.5	System Update.....	45
8.18.6	Multiple Users .....	45
8.18.7	Reset Options.....	45
8.18.8	About.....	46

9 Troubleshooting..... 47

10 Technical specifications ..... 48

10.1 Restrictions..... 48

10.2 Licenses ..... 48

# 1 Safety Information



In extreme weather (storms, lightning) and long inactivity periods (going on holiday) disconnect the screen from the mains.

The mains plug is used to disconnect the battery from the electrical network and therefore it must remain readily operable. If the battery is not disconnected electrically from the mains, the device will still draw power for all situations even if the TV is in standby mode or switched off.

**Note:** Follow the onscreen instructions for operating the related features.

**Important:** Please read these instructions fully before installing or operating the device.

## WARNING

**This device is intended to be used by persons (including children) who are capable / experienced of using such a device unsupervised, unless they have been given supervision or instruction concerning the use of the device by a person responsible for their safety.**

- Use Thomson Go Plus at an altitude of less than 2000 meters above sea level, in dry locations and in regions with moderate or tropical climates.
- Thomson Go Plus is intended for household and similar general use but may also be used in public places.
- The ventilation should not be impeded by covering or blocking the ventilation openings with items, such as newspapers, tablecloths, curtains, etc.
- The power cord plug should be easily accessible. Do not place any object on the power cord. A damaged power cord/plug can cause fire or give you an electric shock. Handle the power cord by the plug, do not unplug the battery by pulling the power cord. Never touch the power cord/plug with wet hands as this could cause a short circuit or electric shock. Never make a knot in the power cord or tie it with other cords. When damaged it must be replaced, this should only be done by qualified personnel.
- Do not expose Thomson Go Plus to dripping or splashing liquids and do not place objects filled with liquids, such as vases, cups, etc. on or over Thomson Go Plus and its battery (e.g., on shelves above the unit).
- Do not expose Thomson Go Plus to direct sunlight or do not place open flames such as lit candles on the top of or near Smart Display.
- Do not place any heat sources such as electric heaters, radiators, etc. near Thomson Go Plus.
- Do not place the Smart Display on the inclined surfaces.
- To avoid danger of suffocation, keep plastic bags out of the reach of babies, children and domestic animals.
- Carefully attach the stand to the TV. If the stand is provided with screws, tighten the screws firmly to prevent the TV from tilting. Do not over-tighten the screws.
- Do not dispose of the batteries in fire, or with hazardous or flammable materials.
- Do not use household cleaning agents to clean the TV. Instead clean the screen with a soft, dry cloth. Before cleaning, unplug the device for safety.

## WARNING

- Batteries must not be exposed to excessive heat such as sunshine, fire or the like.
- Excessive sound pressure from earphones or headphones can cause hearing loss.

## BATTERY WARNING

This product contains an internal lithium-ion battery. Only use the supplied power adapter. Handle with care to avoid leaks, fire, or explosions. Follow proper battery disposal and charging guidelines to prevent injury or damage.

**ABOVE ALL - NEVER let anyone, especially children, push or hit the screen, push anything into holes, slots or any other openings in the case.**

## 1.1 Markings on the product

The following symbols are used on the product as a marker for restrictions and precautions and safety instructions. Each explanation shall be considered where the product bears related marking only. Note such information for security reasons.



Class II Equipment: This appliance is designed in such a way that it does not require a safety connection to electrical earthing.



This marking indicates that this product should not be disposed of with other household wastes throughout the EU. Please recycle it responsibly to promote the sustainable reuse of material resources. To return your used device, please use the return and collection systems or contact the retailer where the product was purchased.

## 1.2 Warning

Do not ingest the battery. If you think batteries might have been swallowed or placed inside any part of the body, seek immediate medical attention.

Keep new and used batteries away from children. If the battery compartment does not close securely, stop using the product and keep it away from children.

Thomson Go Plus may fall, causing serious personal injury or death. Many injuries, particularly to children, can be avoided by taking simple precautions such as:

- ALWAYS use the mounting method recommended by the manufacturer of the Smart Display.
- ALWAYS route cords and cables connected to your device so they cannot be tripped over, pulled or grabbed.
- NEVER place Thomson Go Plus in an unstable location.
- NEVER place items that might tempt children to climb, such as toys and remote controls, on top of the Smart Display.

- NEVER leave children unattended around the device. Children may attempt to push, climb or move the stand, which could result in tipping, injury or damage.

If the existing Smart Display is going to be retained and relocated, the same considerations as above should be applied.

Apparatus connected to the protective earthing of the building installation through the mains connection or through other apparatus with a connection to protective earthing – and to a television distribution system using coaxial cable, may in some circumstances create a fire hazard. Connection to a Thomson Go Plus distribution system has therefore to be provided through a device providing electrical isolation below a certain frequency range (galvanic isolator).

## 2 Installation Instructions for Lifter and Smart Display

### 2.1 Assembly of Lifter

1. Take the first layer out of the packaging and place it next to the box.
2. Take out the battery/base and the lifter.

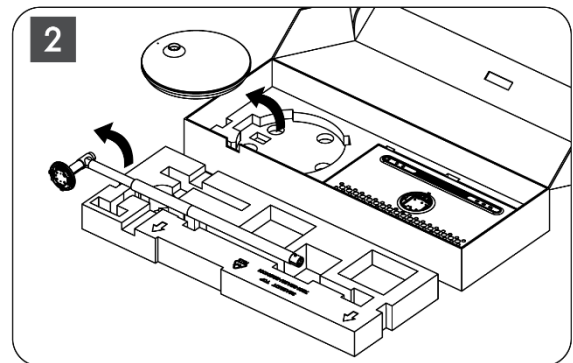
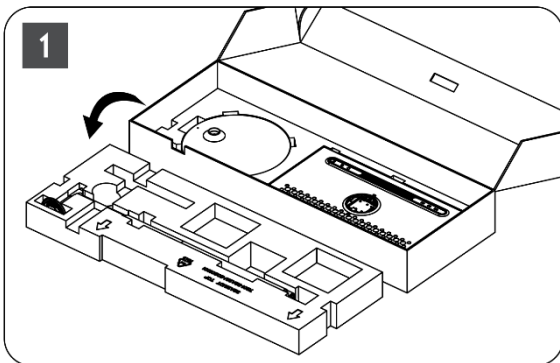

3. Put both layers back into the packaging. Make sure that the first layer is on top again.
4. Place the holder base with the wheels into the slot provided in the first layer of the packaging.

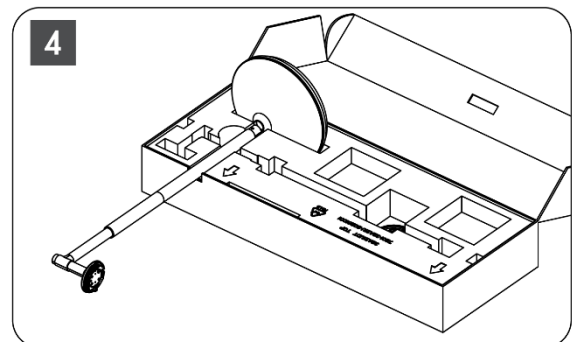
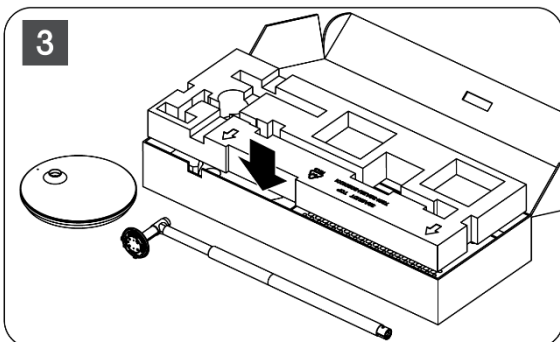

5. Install the lifter to the base by aligning it with the slot position.
6. Insert the screws into the screw slot and tighten the screws.

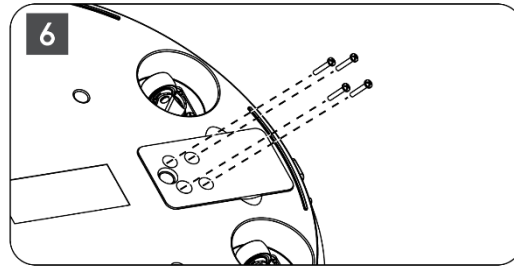
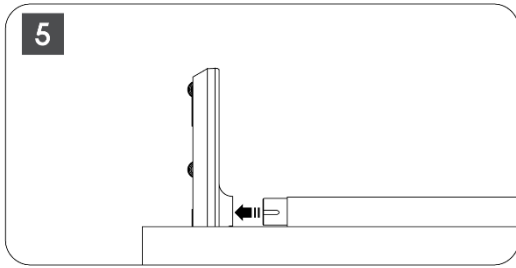

## 2.2 Assembly of Display Screen

7. Tilt the display screen upward, aim it at the support rod and install it.
8. Rotate the display screen for 90°, then wind the power cable around the lifting rod clockwise, clamp power cable into buckle 1, then insert power cable plug, and finally arrange power cable and clamp it into buckle 2.

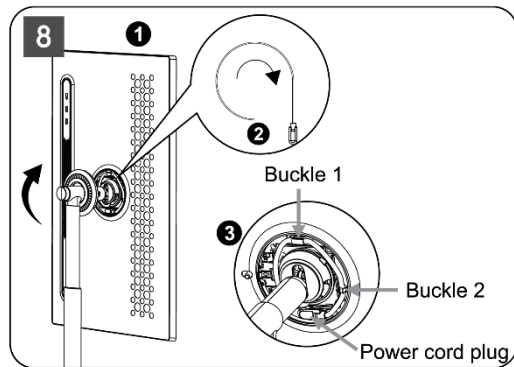
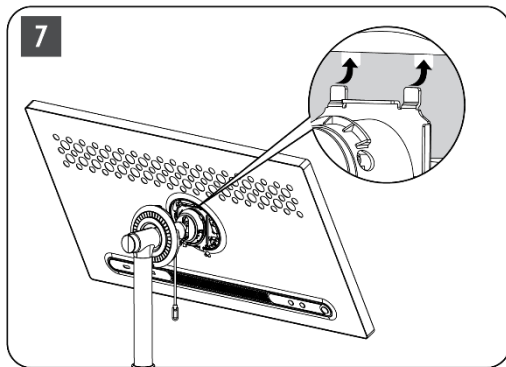

9. Aim the arrow on ring-shaped decoration strip at the arrow of the internal plastic part, press four snaps to assemble. Adjust the angle of the display screen as required.

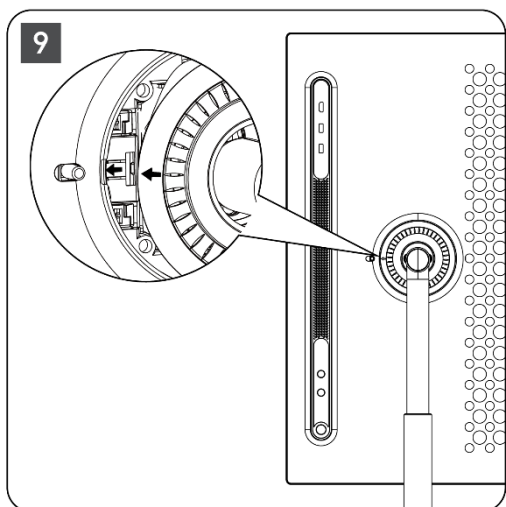



## 2.3 Disassemble the Lifter

To disconnect the screen from the lifter, remove the cover ring, disconnect the power cable and press the quick release button on the back of the device. Then you can remove the display screen from the lifter.

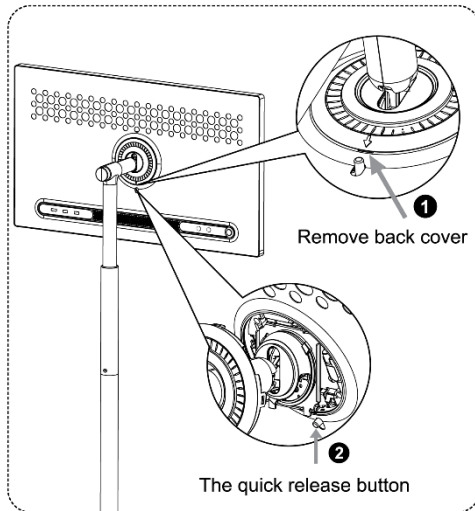

## 2.4 Adjustment of Angle and Height

You can adjust the height and viewing angle of the Smart Display to assure a comfortable viewing experience.

**Note:** Some applications available on Thomson Go Plus do not support vertical display. Please check their descriptions to learn more.

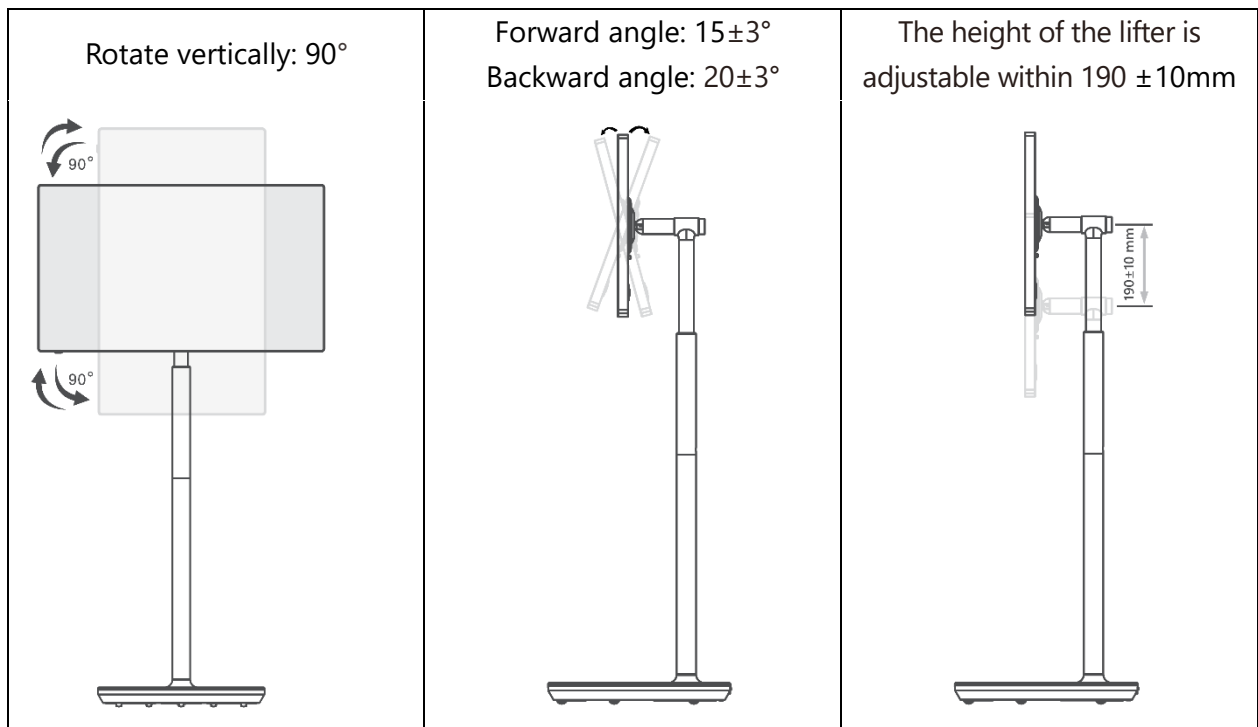

**Caution:**

- Before adjusting the height and the angle of the Smart Display ensure enough space without obstacles for adjustments.
- Do not rotate Thomson Go Plus at an angle beyond the limit or beyond the maximum adjustable height range.
- Do not let your hands or fingers get stuck in the stand or height adjustment area.

## 3 Operation buttons and connections

### 3.1 Connections

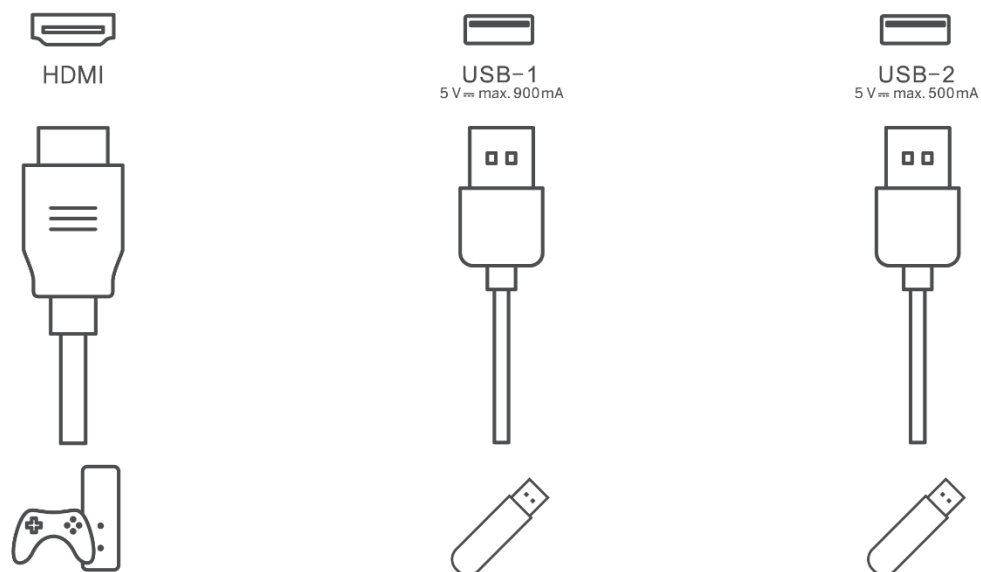

**Note:** The peripheral equipment and cables described in this manual should be purchased separately.

**Attention:** First plug the power cable into the device, then insert the power adapter into the wall socket.

## 3.2 Button Functions

### 3.2.1 TV control buttons

On/Off: Power on or off the device

- ⏻ Power Button:
- In standby/screen-off mode, press ⏻ button to turn on the Smart Display.
  - During normal operation of the device, press ⏻ button to enter screen-off state.
  - Press & hold ⏻ button to activate Google Assistant/Gemini.
    - From the drop-down menu on screen or in the All apps menu select Settings (icon) > System > Gestures > Press & hold power button, then click "Power menu" or "Digital assistant" to set functions of Press & hold power button as needed.
    - Note that the device itself doesn't have a built-in microphone.

⊕ VOL+: Increase the volume.

⊖ VOL-: Decrease the volume.

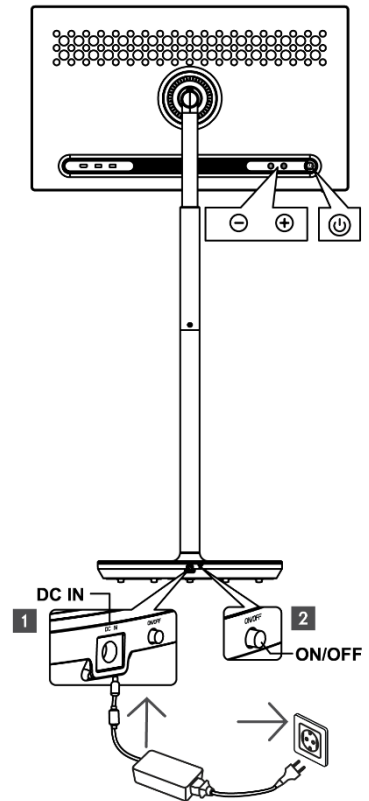

### 3.2.2 Power supply connection and Power On/Off button on the TV stand

#### Power supply

Connect the plug from the power adapter to the corresponding connector on the TV stand to establish a connection to the power supply. Once connected, you can enjoy watching TV while the built-in battery in the stand charges. The battery will continue to charge even when the TV is on standby mode.

#### Power On / Off Main switch

To power the TV on or off, press the main power switch. When the TV is turned off via the main switch, it will not respond to the control buttons on TV or remote-control commands.

### 3.3 Use of Internal Battery

The base of Thomson Go Plus stand contains an internal battery that can power the product for up to 4 hours when Thomson Go Plus is not connected to the power supply. The battery light indicator has three different colors (green, yellow and red), which changes with the remaining battery capacity.

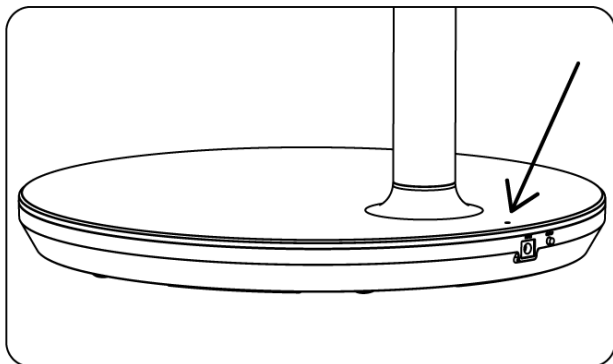

#### **Battery indicator:**

When the TV is connected to the power supply:

- Green light flashing: Battery is fully charged

When the TV is not connected to the power supply (battery operation):

- Green light: The battery capacity is adequate.
- Yellow light: The battery capacity is moderate.
- Red light: The battery capacity is low

#### **Note**

- It takes about 4 hours to fully charge the battery when the Smart Display is turned off.
- The battery capacity decreases depending on the operating time. This means that the battery capacity decreases slightly after prolonged use of the TV, i.e. after months or years, which is also expected operation of battery.
- The remaining battery capacity will also decrease in standby mode.
- The maximum operating time after a full charge is approximately 3 hours.
- The operating time of the TV in battery mode may vary depending on the connected devices, operating temperature and user settings. Therefore, the actual operating time may differ from the specified operating time.

## 4 Initial Setup

For the first initial setup, on-screen setup wizard will guide you through setting up your Smart Display.

Please follow the instructions on the screen to set up Thomson Go Plus. Use the touchscreen function of the display to select and configure the available options.

### 4.1 Select your Country

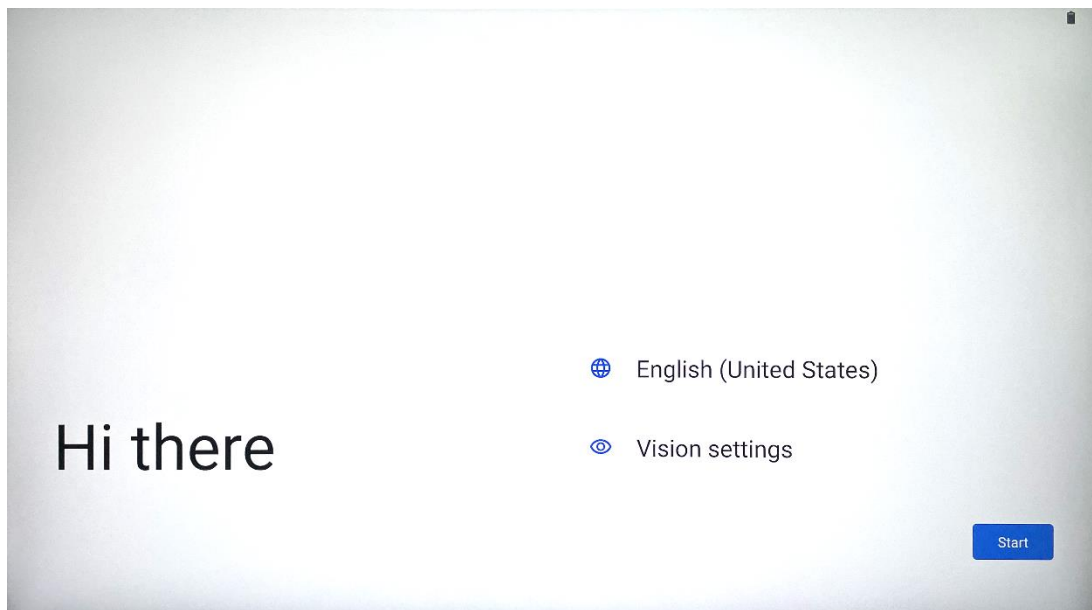

By default, Thomson Go Plus is set to English interface language. It can be changed to any available by tapping on English. Please select your preferred language listed in the list.

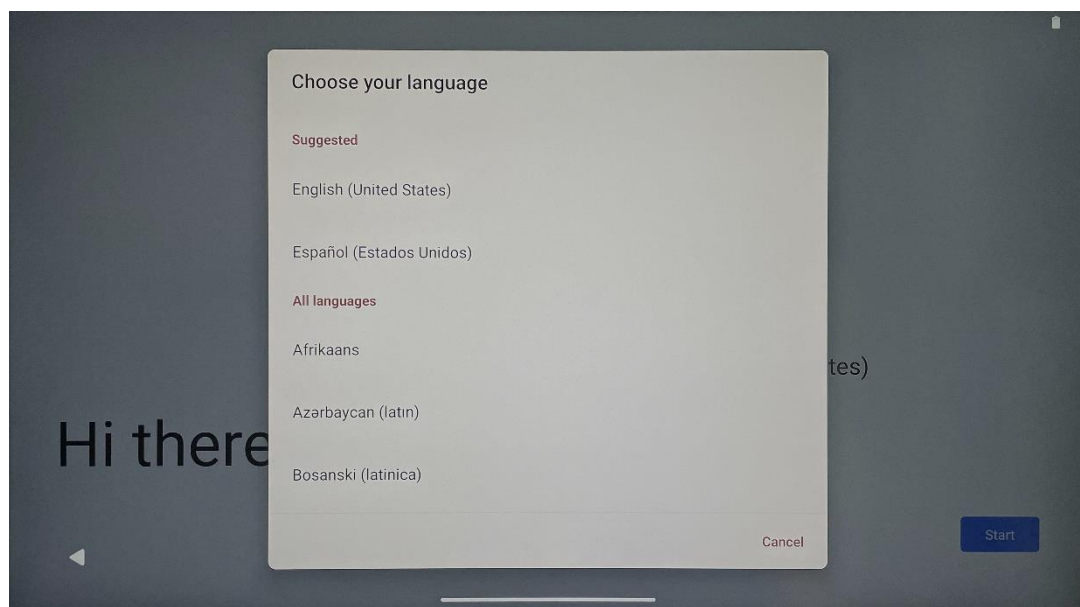

## 4.2 Vision Settings

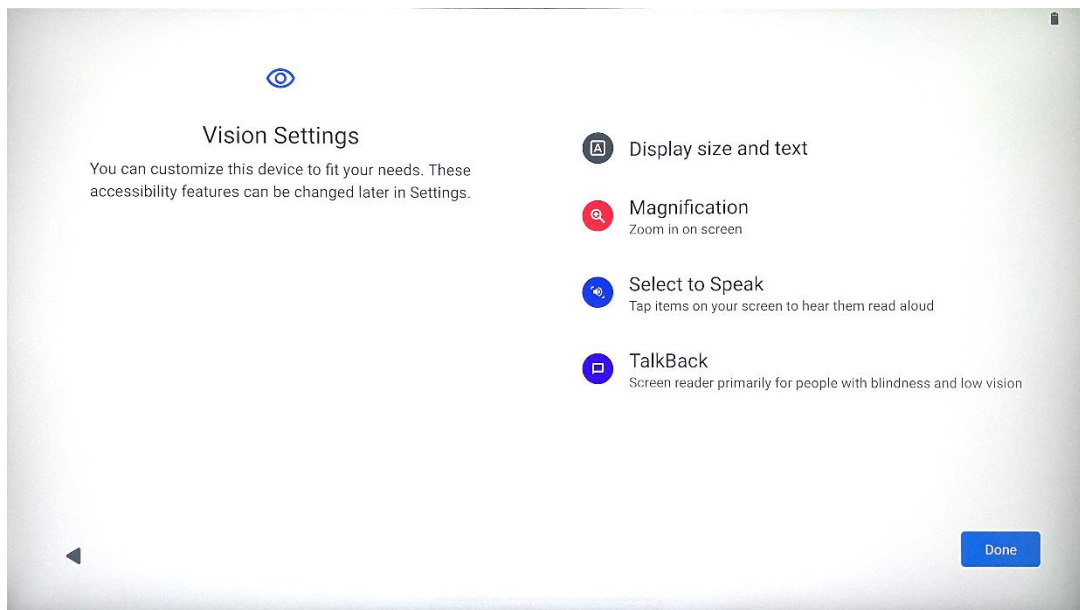

You can adjust the settings of Thomson Go Plus according to your preferences. These accessibility features can be changed later in the Settings.

- **Display size and text:** Adjust font's size.
- **Magnification:** Enable zooming in/out function.
- **Select to Speak:** When tapping an item on the screen, the Smart Display will read aloud the selected item.
- **TalkBack:** The most suitable for people with blindness and low vision. Thomson Go Plus will provide spoken feedback so that the device can be used without looking at the screen.

After selecting your language and setting up accessibility features if needed proceed by tapping Start.

## 4.3 Wi-Fi connection

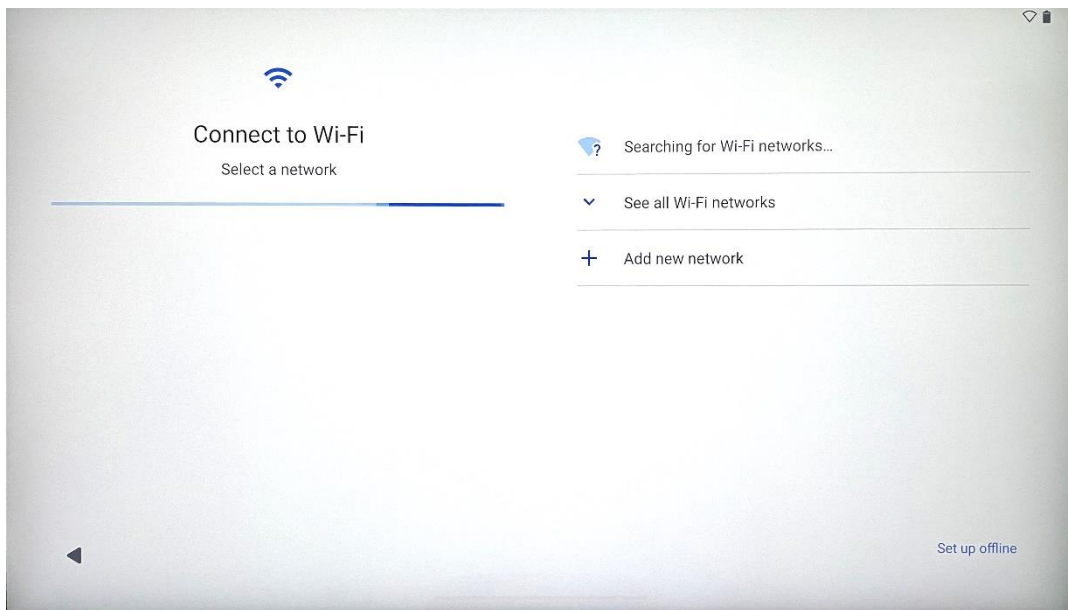

Select an available Wi-Fi network or add one manually. You may setup the device offline, however, it is recommended to connect Thomson Go Plus to the Wi-Fi network for better experience and latest features from Google.

When the network is selected, enter a password and press Connect.

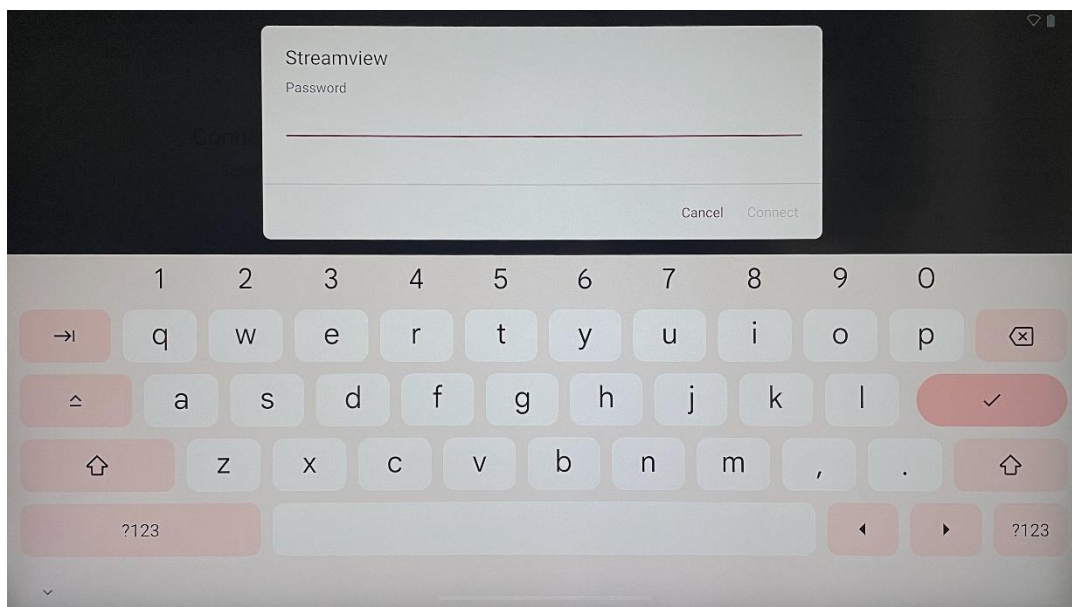

## 4.4 Copy apps & data

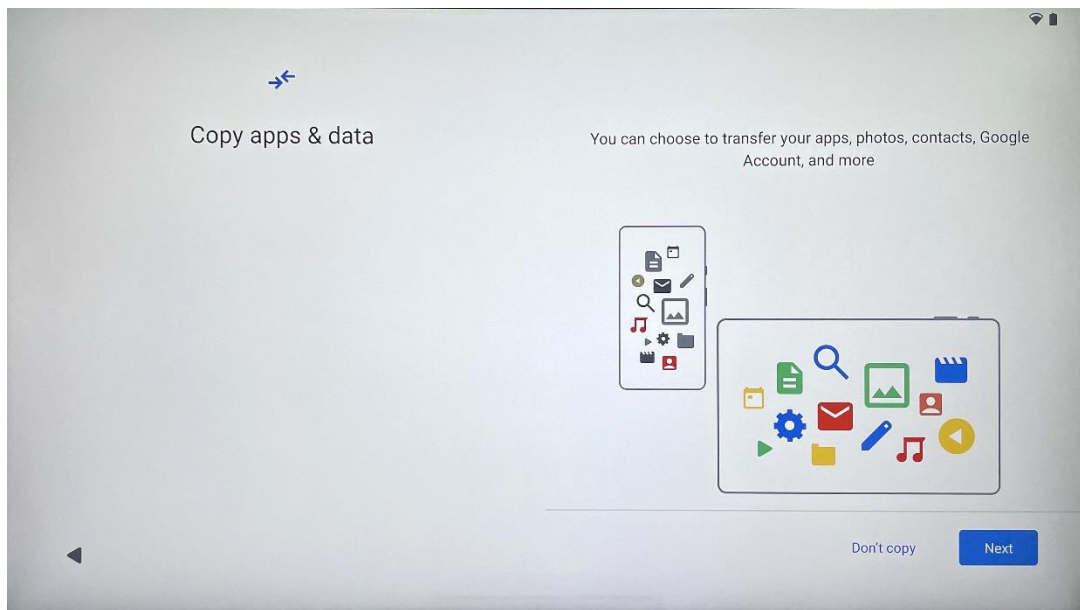

You may choose to transfer your apps, photos, contacts, Google Account and other information from your previous or current device. Tap Next and proceed according to the setup wizard on-screen. The transferring process may differ and depends on another device you wish to transfer data from.

## 4.5 Create user

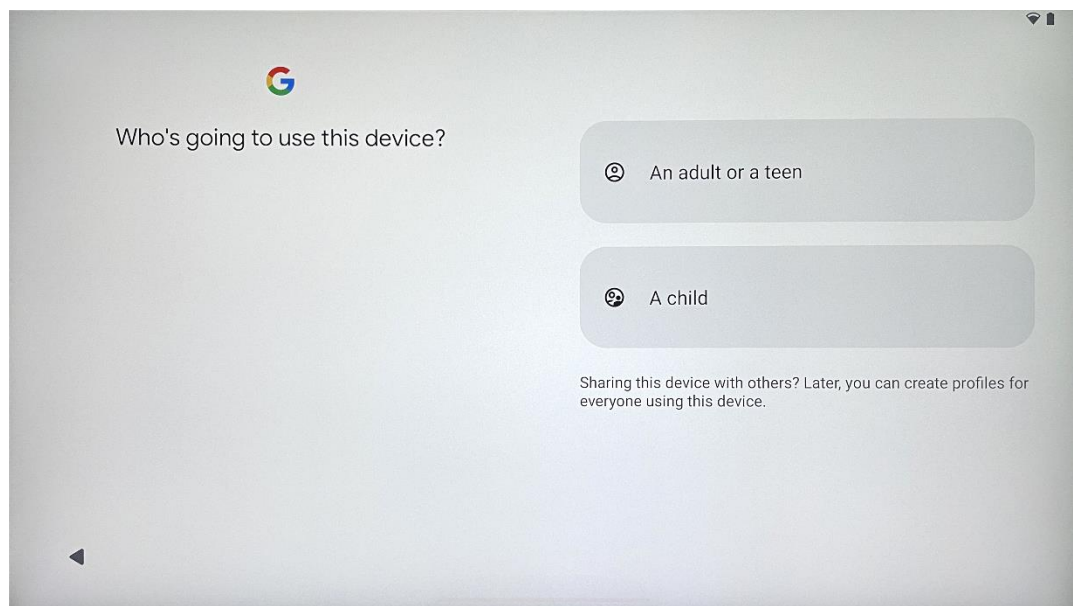

Please create or connect an existing Google account to Thomson Go Plus. If your child is a primary Smart Display user, you will be prompted to either create a new account or connect an existing one.



Please note that creating or connecting a child's Google account will require an existing parent's Google account, and the child's account will be connected Google Family Link.

## 4.6 Google account credentials

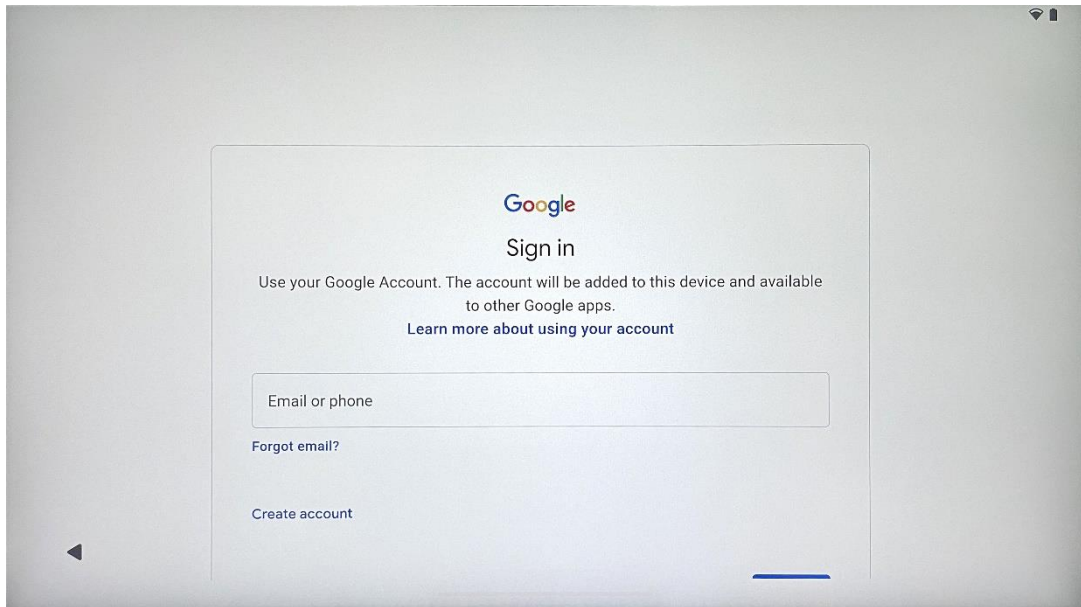

Use the remote control to enter your Google account login and password or create a new one.

## 4.7 Terms of Service and Privacy Policy

Read and review Google Terms of Service and Privacy Policy. By continuing, you accept Google terms to improve the product experience. Select "I agree" to proceed.

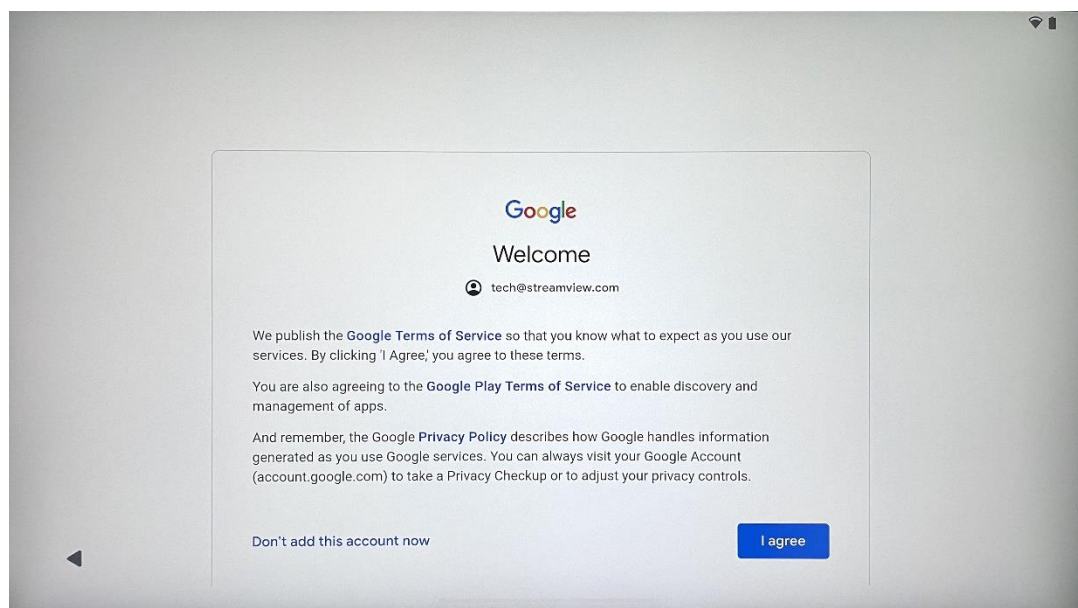

## 4.8 Google services

Select "Accept" to confirm, if you want your location identified on your Thomson Go Plus and agree to automatically send diagnostic information to Google to help improve your Google experience.

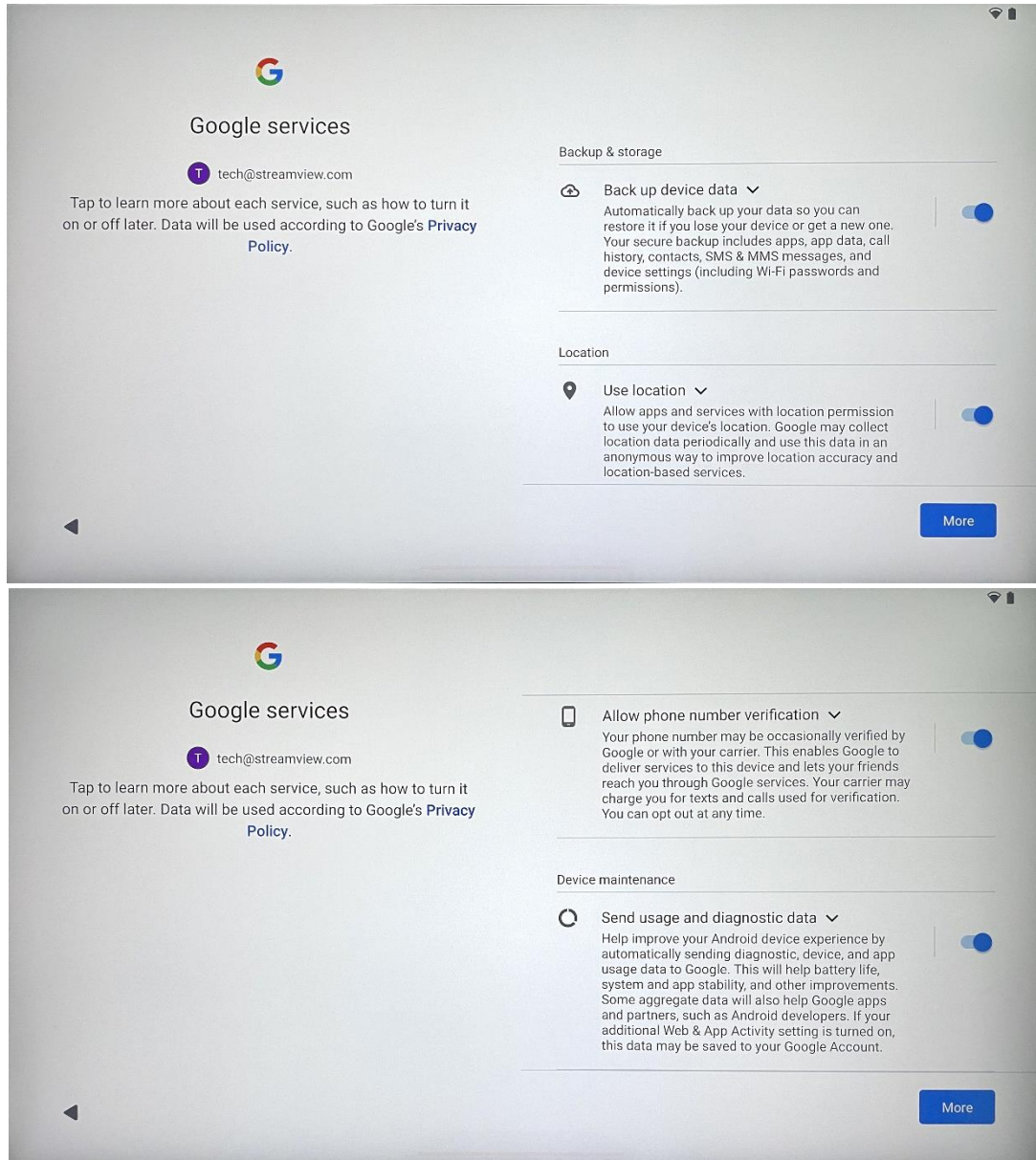

## 4.9 Create PIN

This PIN code (Personal Identification Number) is a numeric password used to authenticate access to the device, specific features or protect app or account data.

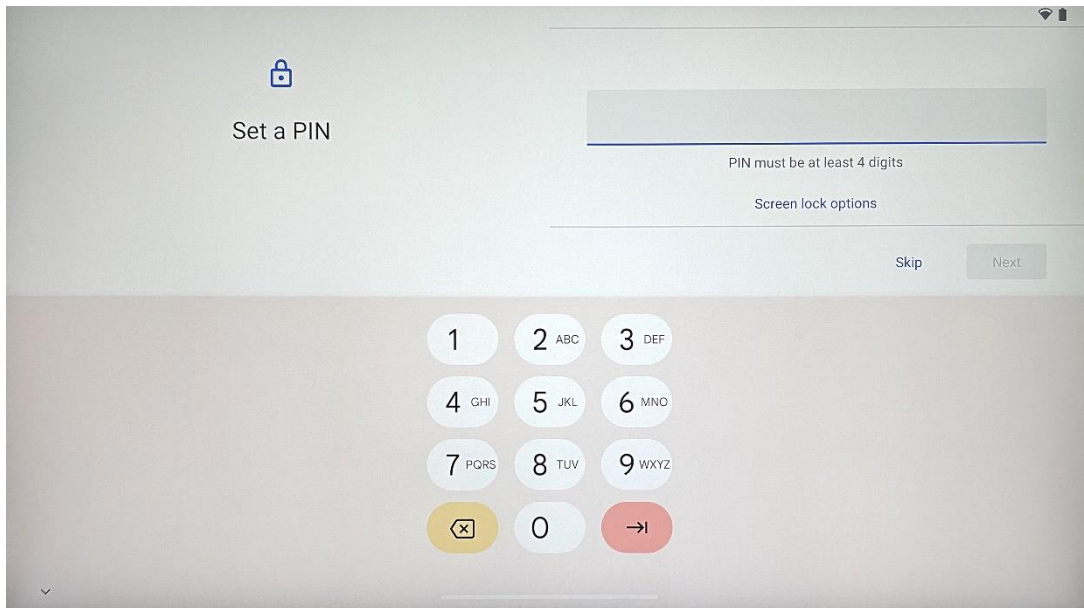

## 4.10 Activate "Hey Google" for Google Assistant

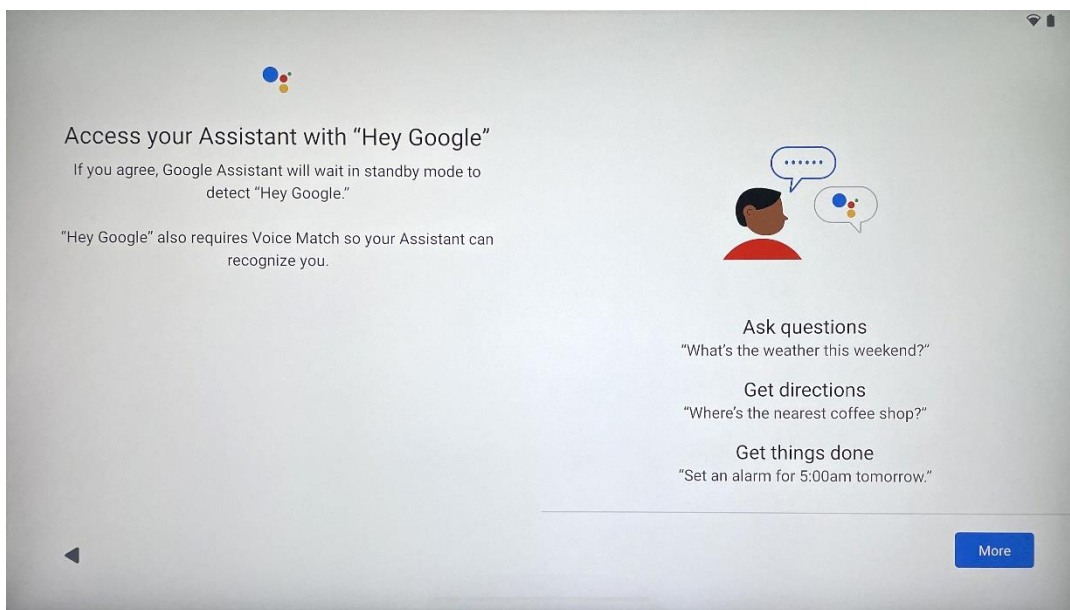

By simply saying "Hey Google" Google Assistant will wake up from standby mode and respond to your request.

You will get a teaching Google Assistant prompt, if you have not done it yet. Voice Match allows your Assistant to identify you and recognize your voice among others. Follow on-screen instructions to form a unique voice model.

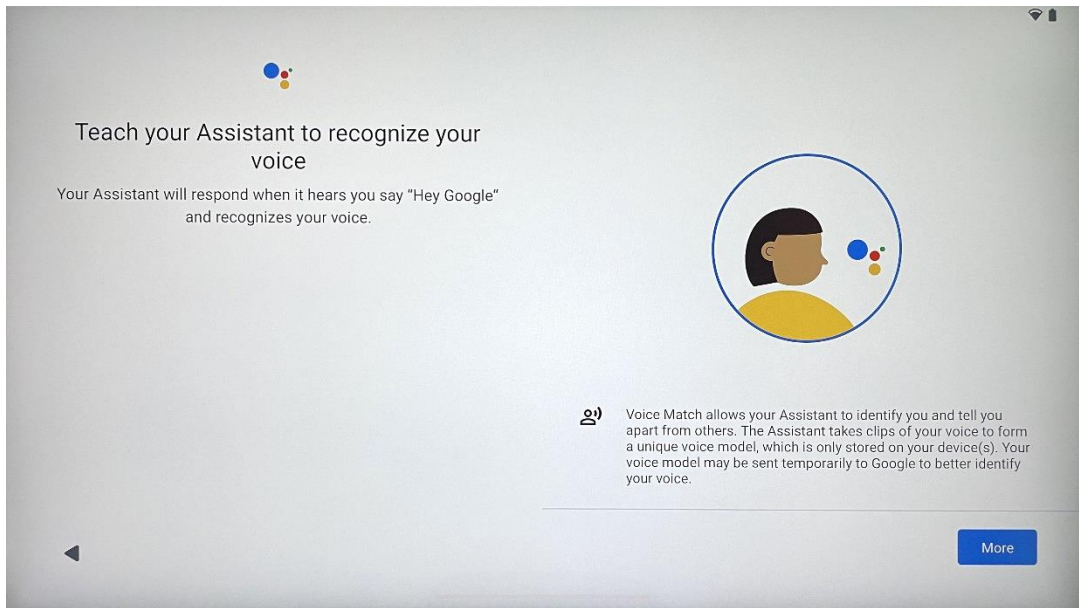

## 4.11 Add a card to your Google Play

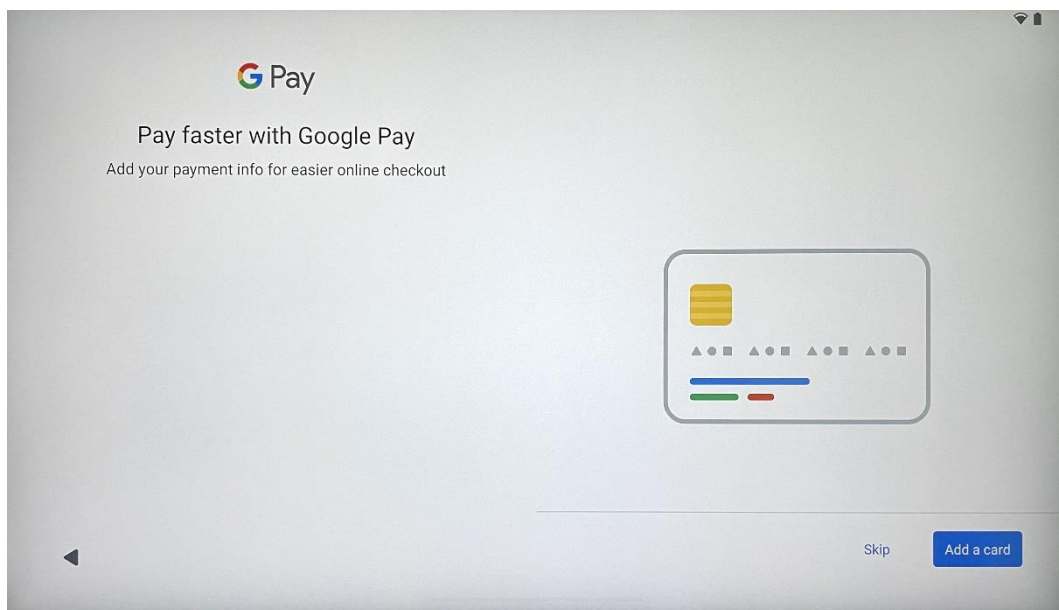

Add your bank card to Google Pay to be able to pay fast and secure for apps, services and products, which are available in the google play store or other apps.

## 4.12 Additional Settings

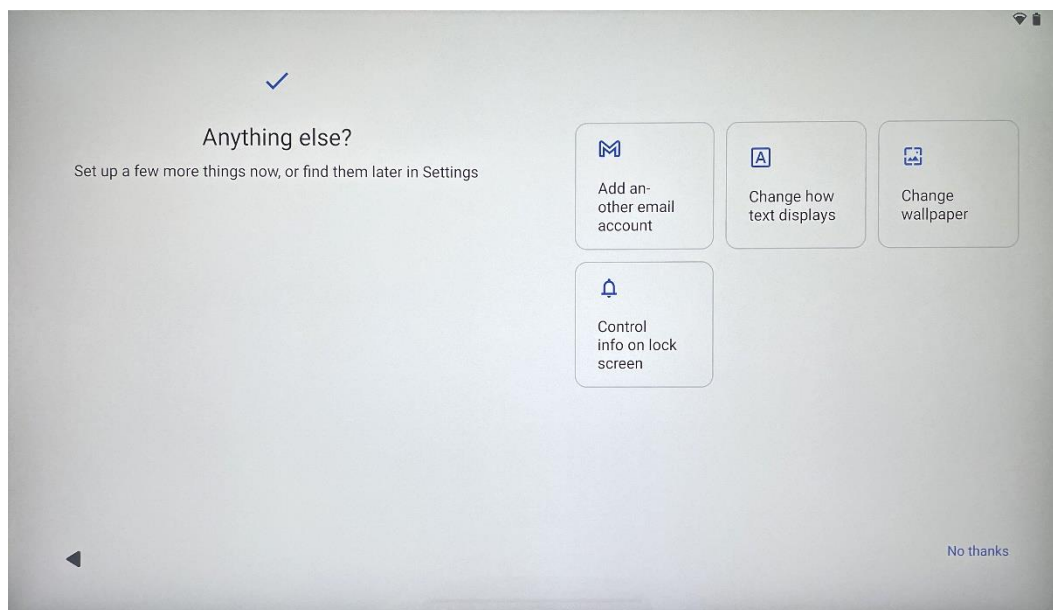

You may setup additional settings of your Thomson Go Plus such as adding additional Google accounts, changing font appearance, changing wallpapers and editing which information should be displayed on the lock screen.

You may change these settings later in the settings menu.

## 4.13 Remote control pairing

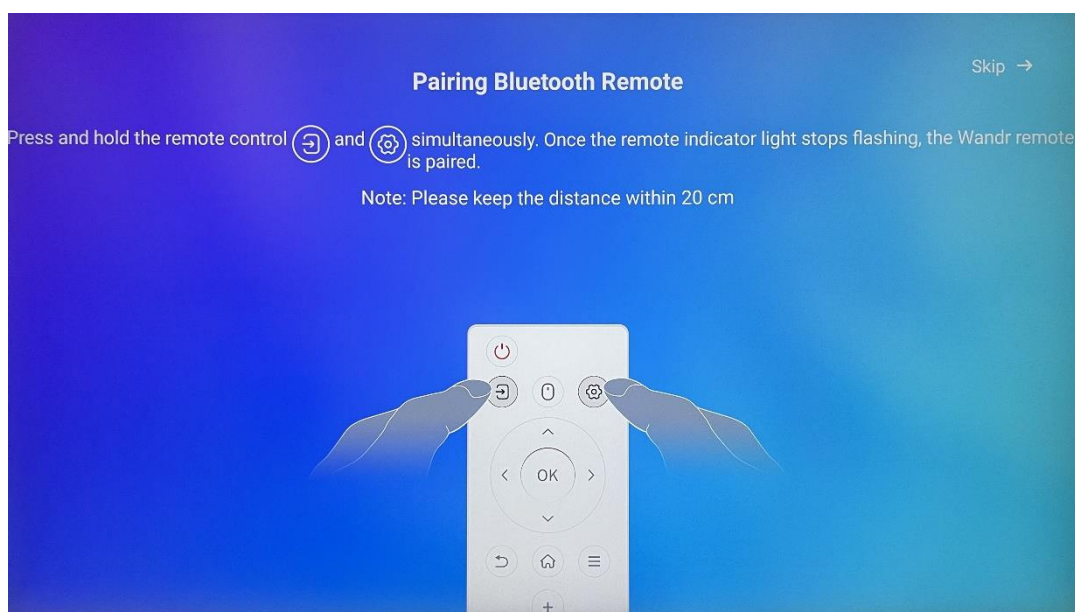

The usage of the remote control can be possible only via Bluetooth. To pair your remote control with Thomson Go Plus, please press & hold the source and the settings buttons simultaneously as shown in the picture or on the Smart Display keeping the distance within 20 cm. After 3











seconds the light indicator of the remote control will start flashing. Please wait till you see that the pairing is successful on the screen.

You may connect the remote control later in the settings.



## 5 Remote Control and Touch Screen



	Power button: Turn Off/On the screen Long press & hold: Wake up Google Assistant/Gemini or open power menu (Note: no built-in mic available)
	Input: Switch between HDMI input and Smart Display
	Mouse: Activate/deactivate virtual mouse
	Settings: Open Smart Display settings
	Directional buttons: Navigate menus, settings options, follow on-screen instructions
	OK: Confirm selections, enter sub-menus
	Back/Return: Return to the previous menu screen, go one step back, close windows, close the playback of multimedia files
	Home: Open the Home screen
	OSD: Open display menu, open apps settings
	Volume +/-: Control the sound volume of the Smart Display

### Remote control battery:



- Low battery will influence the remote control distance, in such case it is advised to replace batteries.
- Always change both batteries and use the same type of AAA batteries.
- Please dispose of the waste batteries pursuant to relevant regulations on environmental protection.

### 5.1 Pairing Bluetooth Remote

During the initial setup you will be able to connect your remote control. Please proceed to Chapter 5.

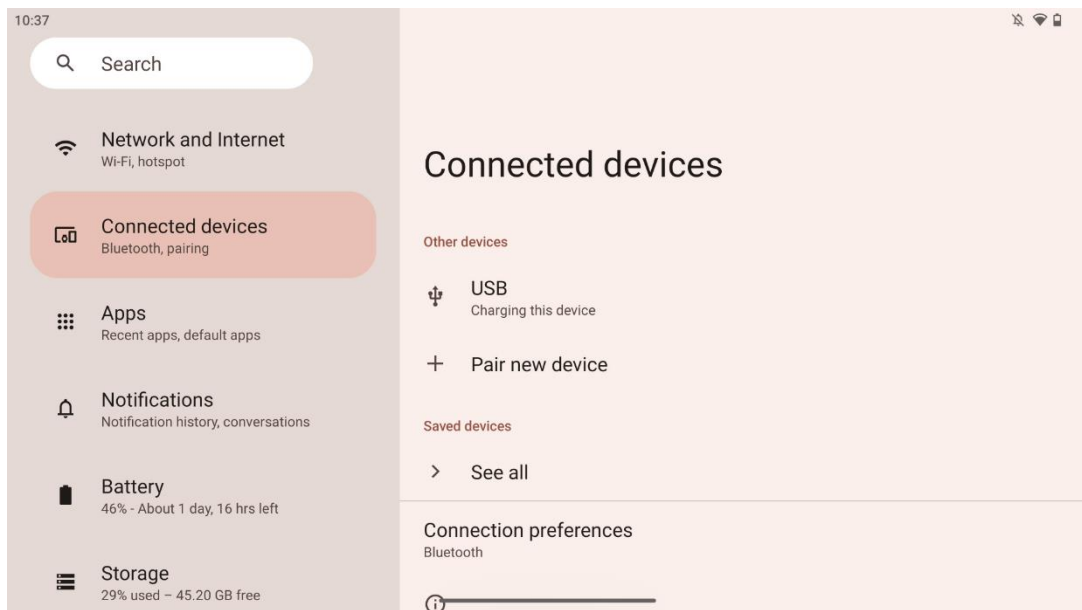
After the initial setup of your Thomson Go Plus proceed to Settings > Connected devices > Pair new device.



The Smart Display will start looking for a new Bluetooth device. In the meantime, please press & hold simultaneously  and  buttons until the remote control light indicator starts flashing.

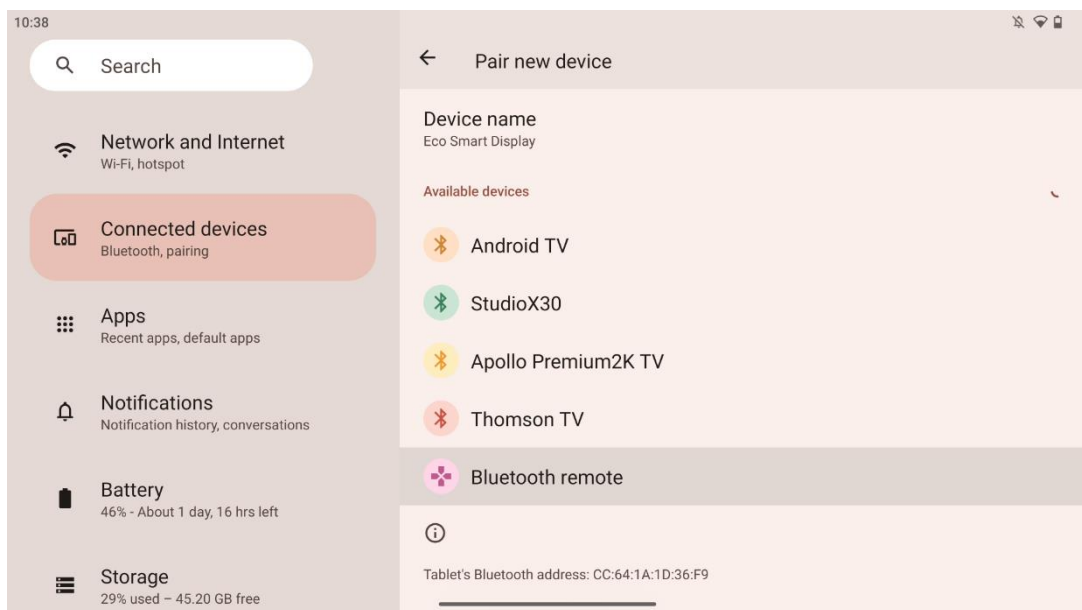

On the Smart Display look for “Bluetooth remote” and click on it by using a touch screen. The dialog window will show up.



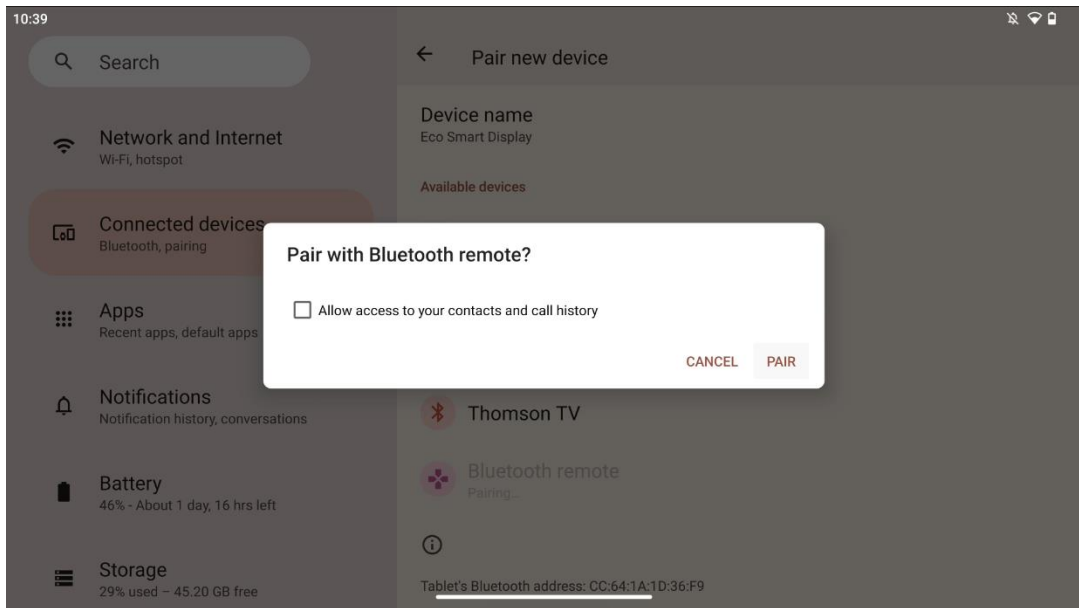

Please click on Pair and your remote control is connected to Thomson Go Plus.

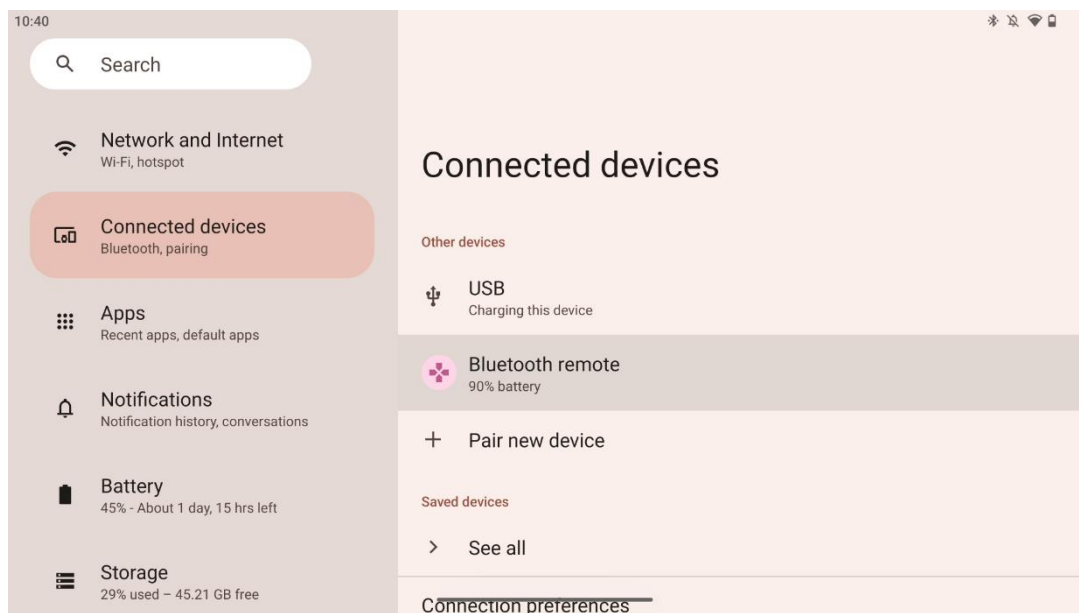

## 6 Touch Screen Operation

- **Click:** Tap on the screen.
- **Click & hold:** Tap on the screen for 2s or longer.
- **Swipe:** Swipe on the screen up, down, left and right.
- **Drag:** Tap & hold the target (e.g., an application) to be moved, then swipe to the desired position.
- **Open/close:** Pinch two fingers on the screen, then open or close these fingers to zoom in/out the content displayed on the screen.

**Note:** After the screen is off, double tap on the screen to wake the screen up.

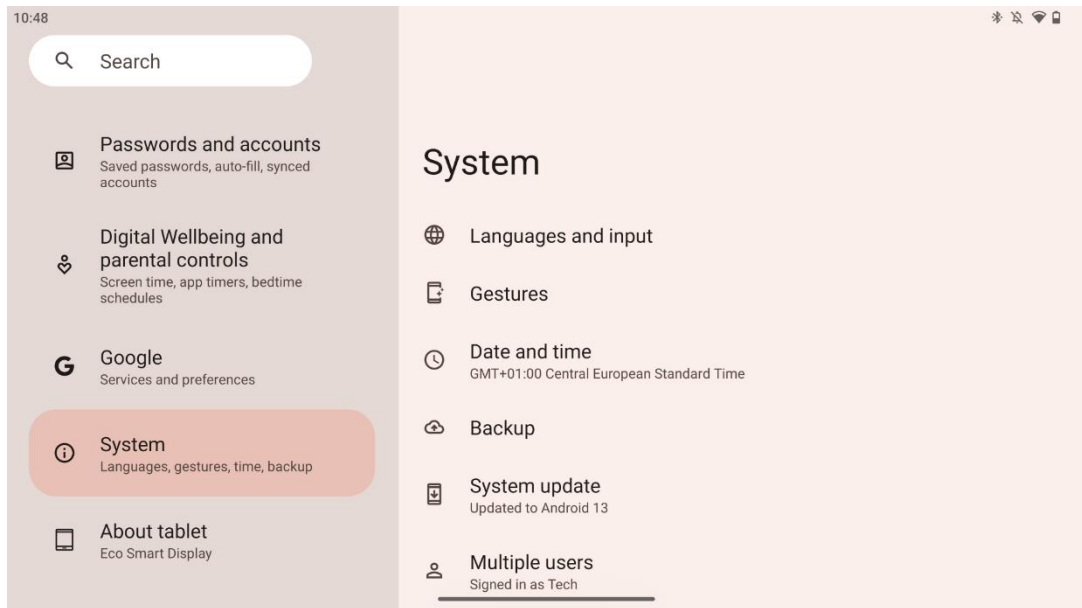

After initial setup you can choose navigation mode.

Proceed to Settings > System > Gestures > System navigation to select the system navigation mode.

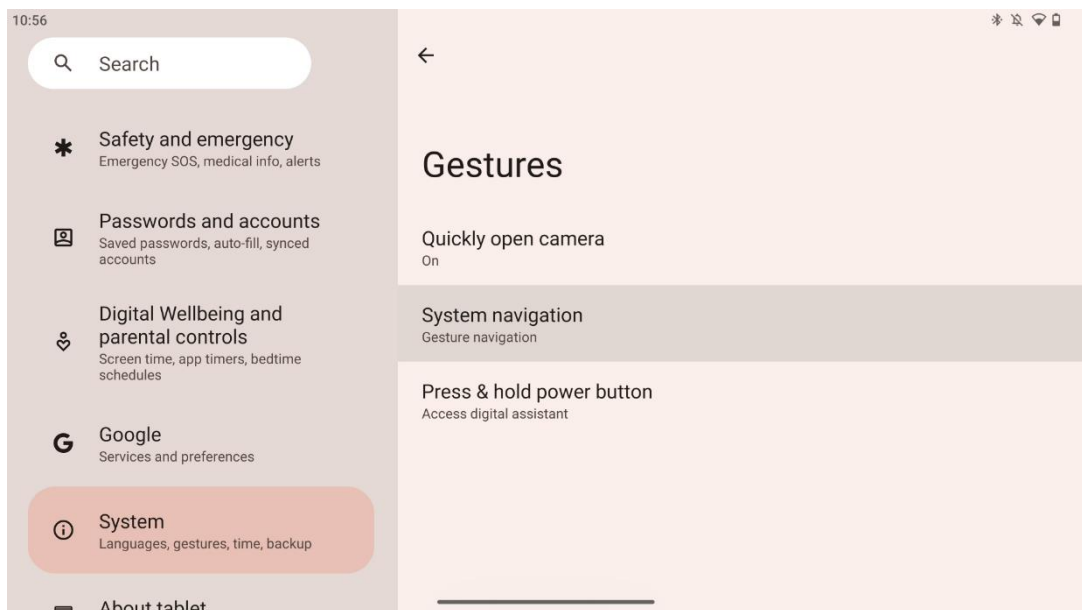

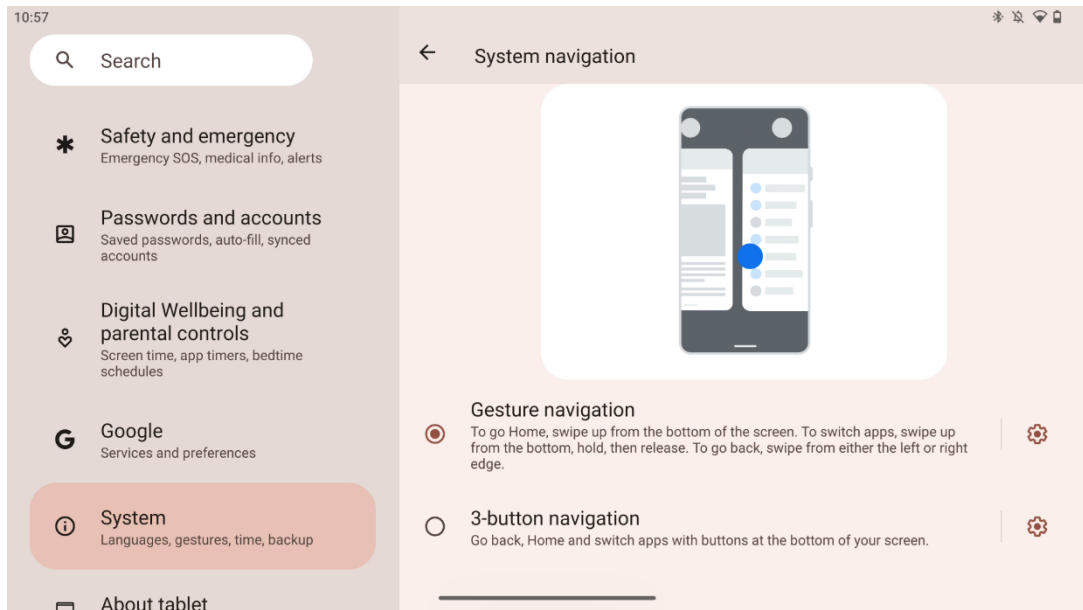

**Attention:**

- The availability of zooming in/out a content depends on whether an application supports this functionality.
- Avoid pressing the screen with force; where necessary, simply use your fingertip to tap on the desired item. If you wear gloves or use your fingernail to operate the touch screen, it is possible that the product will not respond or operate normally.
- If the screen is wet or too damp, the sensor cannot work normally when touching it.

## 7 Home Screen



The home screen of Thomson Go Plus features a grid layout with app icons, widgets, and a customizable background. At the bottom, there's a persistent dock for frequently used apps. A

status bar at the top displays time, notifications, battery, and connectivity indicators. Swiping up or tapping an app drawer icon reveals all installed apps. Pages can be swiped left or right to access additional screens for more icons or widgets.

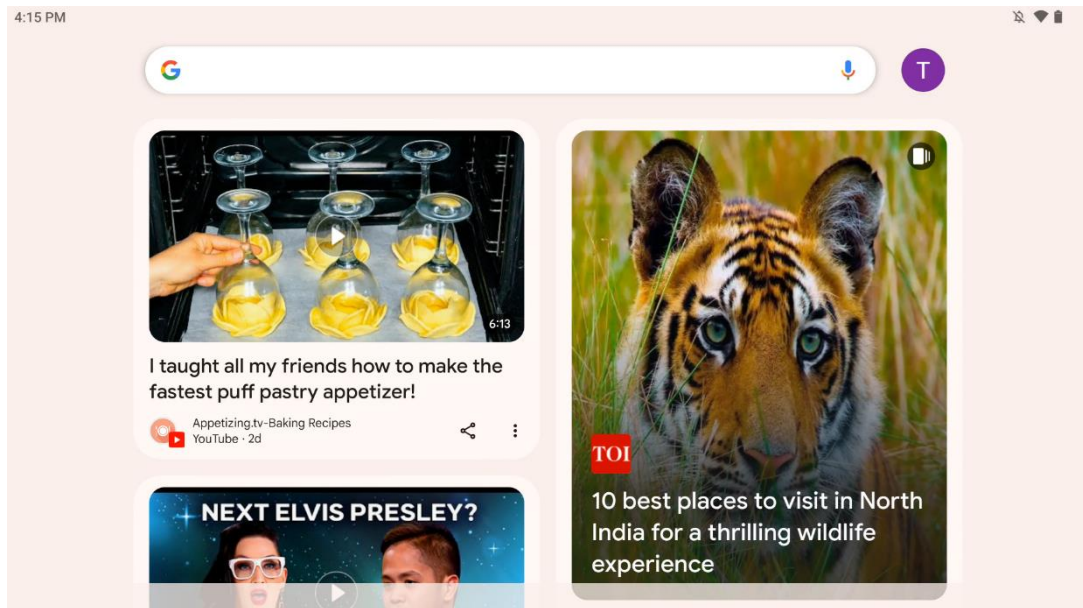

By swiping right, a discovery screen will be shown with the suggestions based on your preferences in your Google Account.

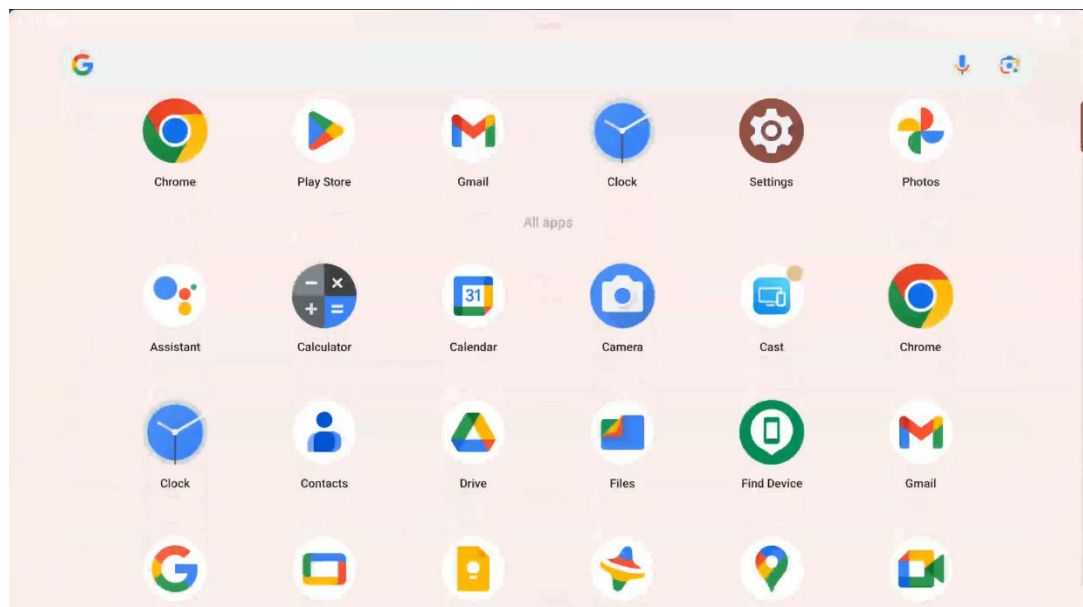

The app drawer can be shown by simply swiping up. It is a place where all your installed apps are. You open these apps, move them to the home screen or put them in the dock. The top line of the drawer is showing your recent apps, while all other apps are located below.

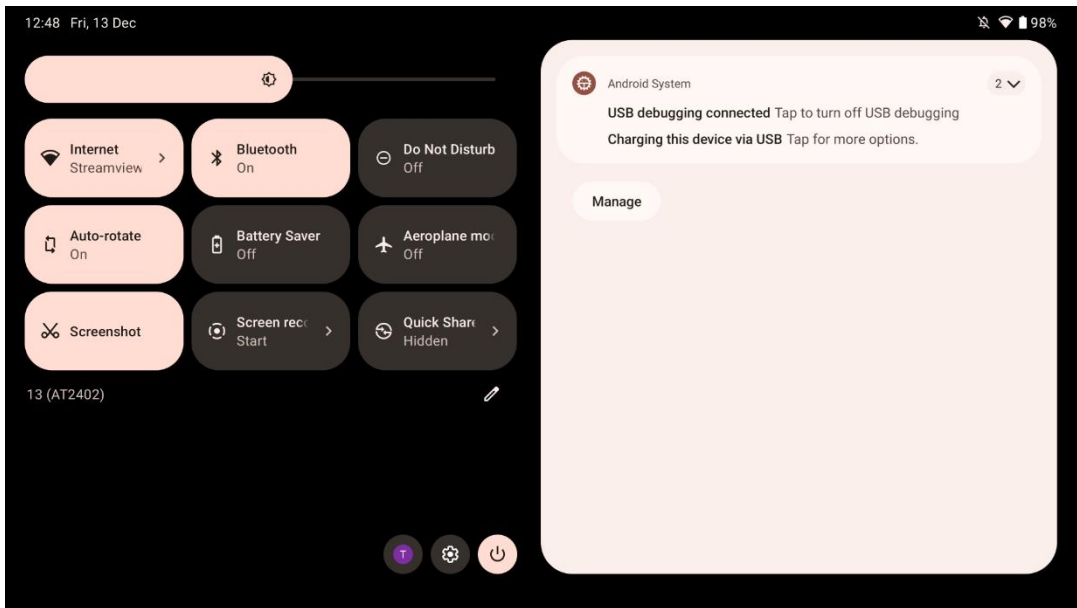

When you swipe down, you can access the Quick Settings Panel on the left and notification centre on the right in the horizontal position. In vertical position the Quick Settings Panel is on the top and notification centre is below. Right below the Quick Settings Panel there are icons for Google Account management, device settings button and power menu.

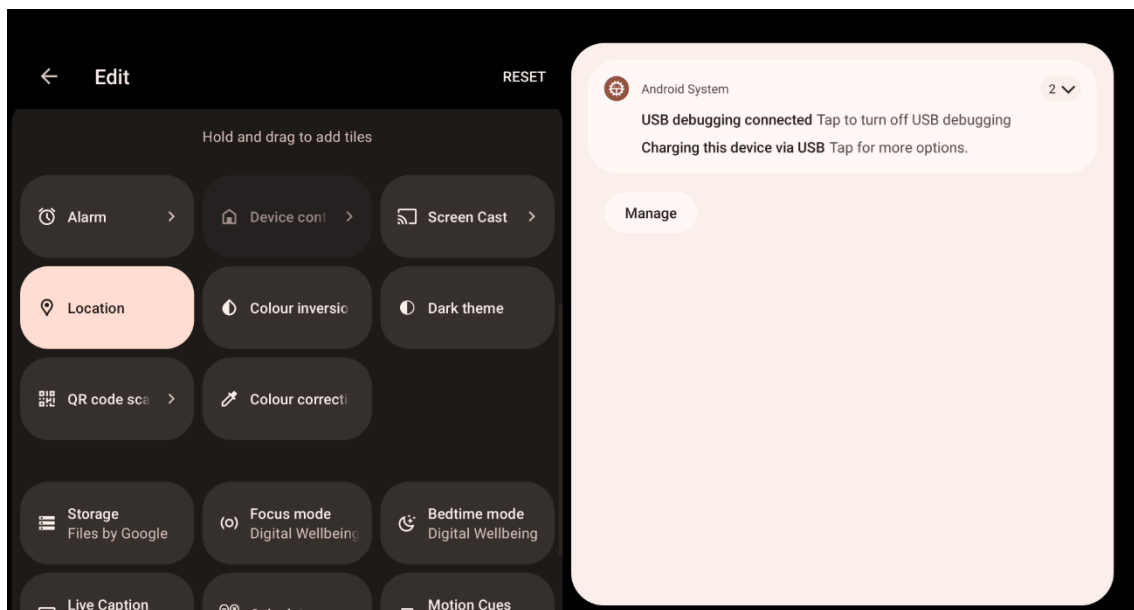

By default, only 9 quick settings are available for you in this menu, however, if you click on the pen button, the list of other available options will appear. You may hold and drag any quick setting to the top list of quick settings tiles as many as you wish.

On another part of the screen, you can overview and manage your system and apps notifications.

## 8 Settings

The general device's settings can be accessible by clicking on the Settings app icon on the Home Screen, apps drawer or below the quick settings panel.

### 8.1 Network & Internet

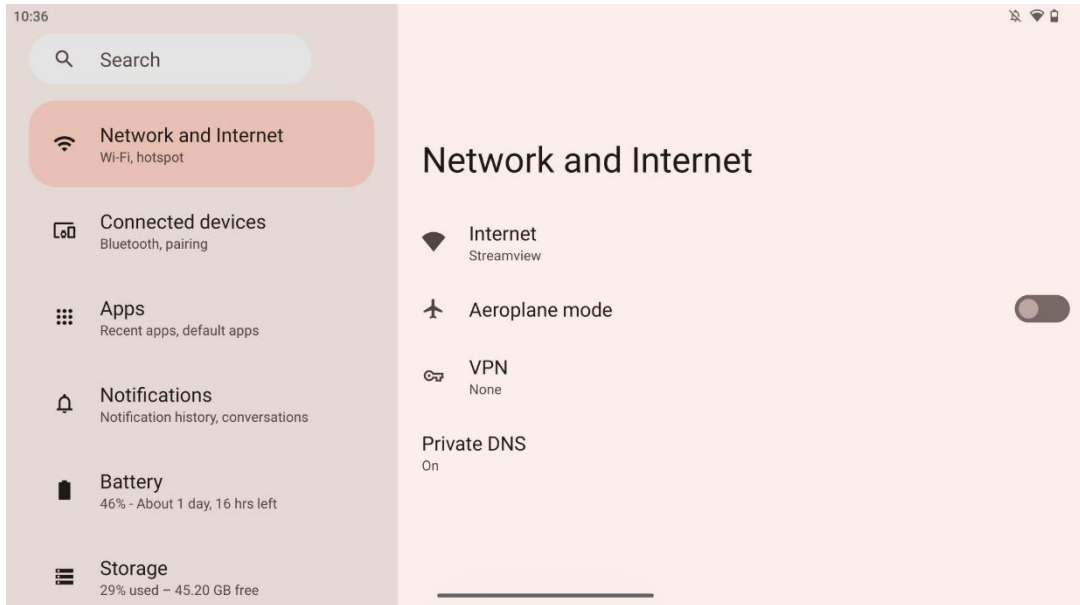

Configure your Smart Display's network settings using the options of this menu.

The following options are available:

- **Wi-Fi:** Turn the wireless LAN (WLAN) function on/off. When the WLAN function is turned on, available wireless networks will be listed. Scroll down to see all available wireless connections or click on "+Add network" to enter manually Wi-Fi information.
- **Network preferences:** Enable automatic turning on near high-quality saved networks, enable notifications on a high-quality available public network, install Wi-Fi certificates and setup a direct peer-to-peer Wi-Fi connection to another device.
- **Saved networks:** Overview all saved networks on your device.
- **Non-carrier data usage:** Overview your overall or by app Wi-Fi data usage.

## 8.2 Connected devices

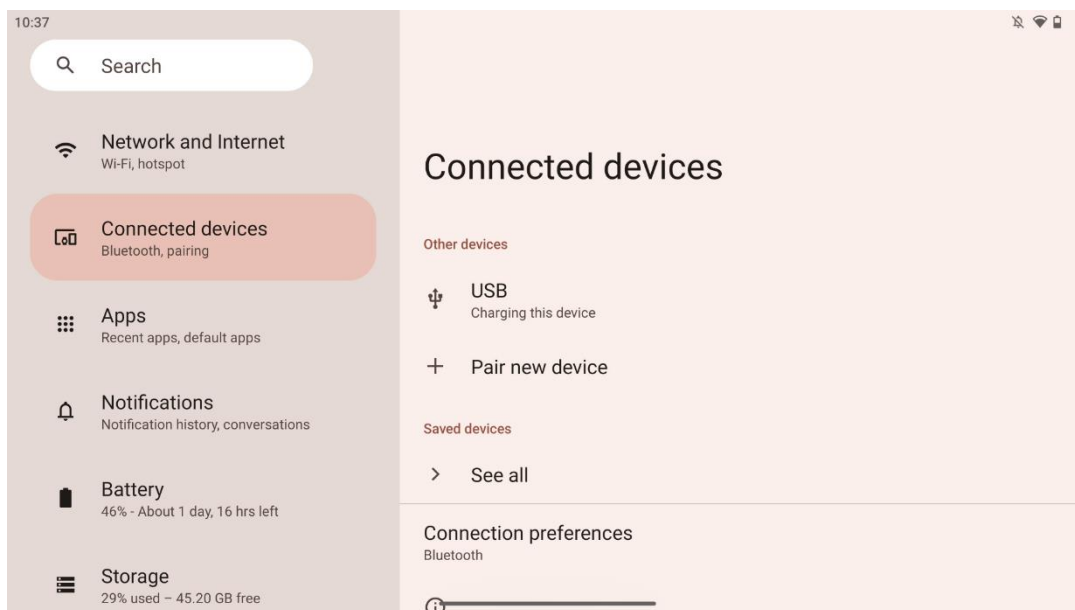

The settings displayed in the menu depend on the connected inputs via USB ports or Bluetooth.

The following options are available:

- **Other devices:** Overview currently connected by USB port or Bluetooth connection available inputs. By clicking on USB-connected or Bluetooth-connected devices, you may setup settings for their respective connectivity. Click on "Pair new device" to start Bluetooth pairing. The pairing process may differ and depends on a device you wish to connect.

**Note:** To pair your remote control with Thomson Go Plus, please click "Pair new device" on the Smart Display and press & hold source and settings buttons simultaneously on the remote control for 3 or more seconds. The light indicator on the remote control should start flashing and "Bluetooth remote" will appear in the list of the available devices. When tapped, a dialog window will appear. Tap on "Pair" and your remote control is connected to Thomson Go Plus.

- **Saved devices:** List all previously saved connected via Bluetooth devices.
- **Connection preferences:** Setup your preferences for Bluetooth, Google Cast, printing and Quick Share connectivity options.

### 8.3 Apps

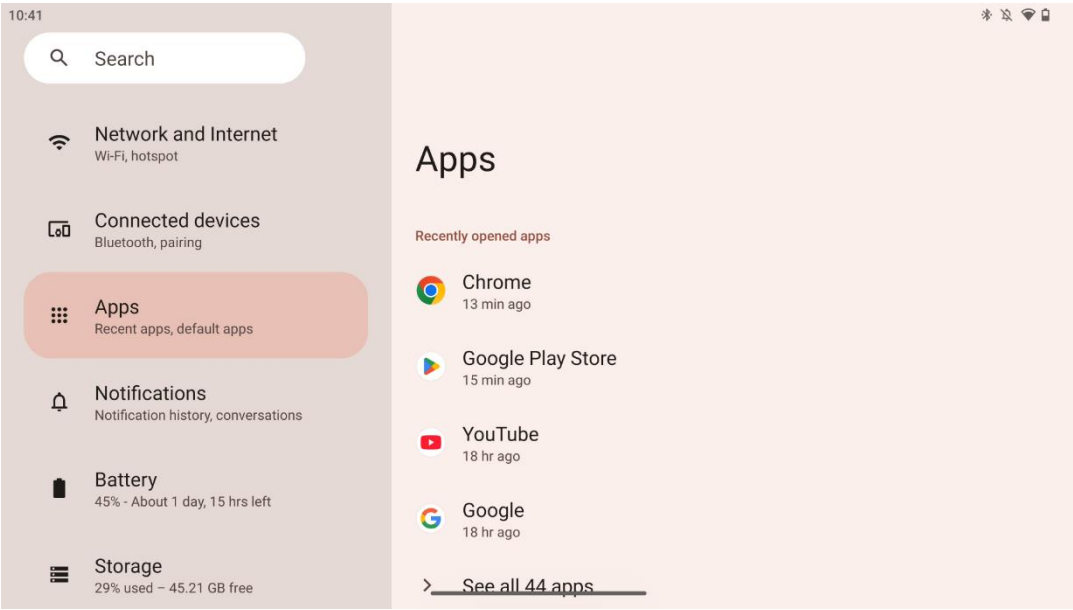

Select "Apps" to display applications installed on your TV.

In this tab you can overview your most recently used apps, see the whole list of installed apps, setup default apps, overview and limit the screen time and provide permissions to the installed apps.

### 8.4 Notifications

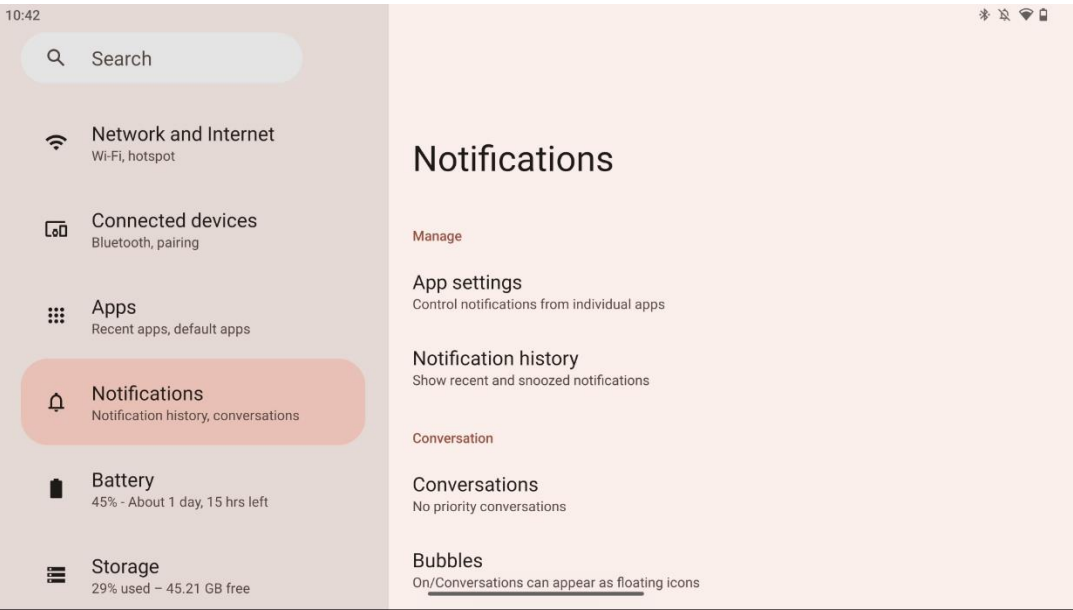

Select the Notifications tab to display available settings for Thomson Go Plus.

The following options are listed below:



- **Manage:** Change notifications settings for each installed apps on your device and overview the notification history.
- **Conversation:** Setup notification settings for the communication apps.
- **Privacy:** Set your privacy preferences for device & app notifications, notifications on the Home Screen and sensitive notifications.
- **General:** Set the general notification settings.

## 8.5 Battery

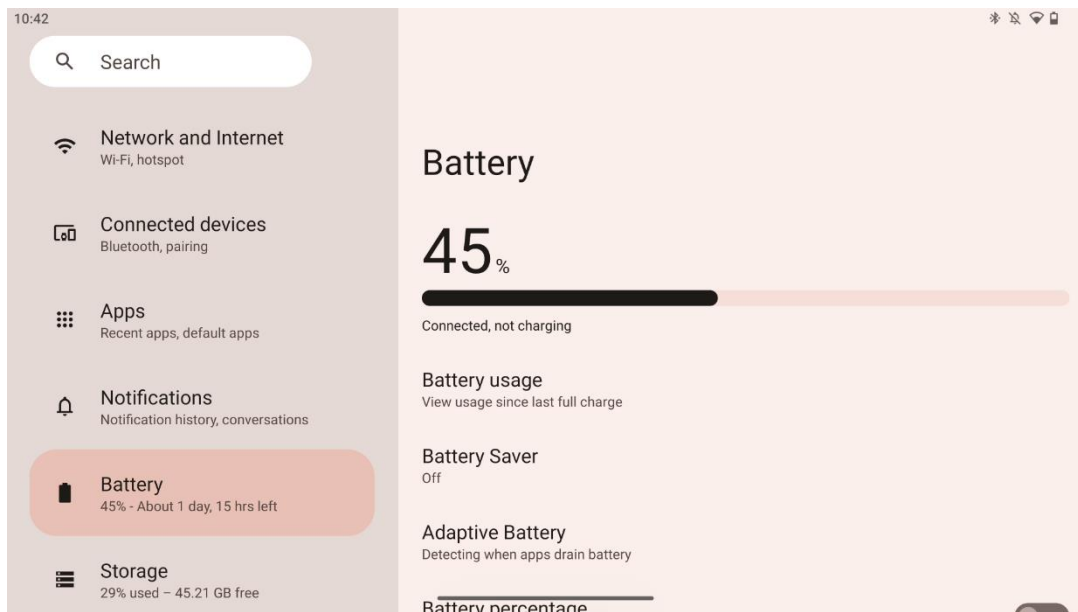

In this Settings tab you may overview the current charging level of the battery. Additionally, you can overview the battery, enable battery saver and enable battery percentage, which will be shown in the status bar. Moreover, you can enable adaptive battery, which detects high-draining apps and optimize battery usage, to provide you with the proper battery longevity and minimize battery aging.

## 8.6 Storage

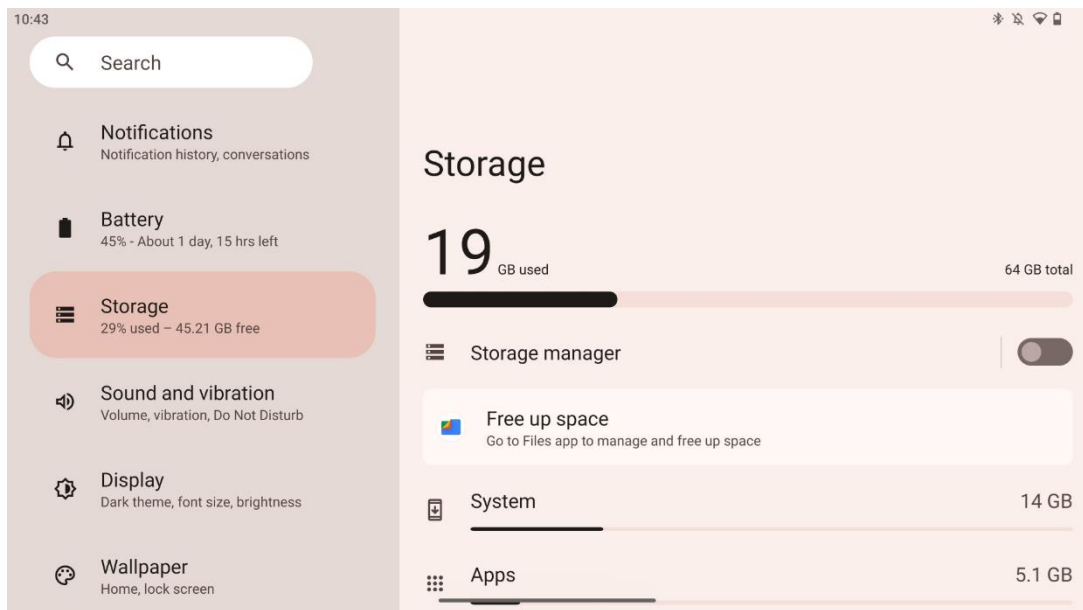

This settings tab shows you storage usage by categories and the volume of the free storage space. Enabling “Storage manager” will allow the Smart Display automatically to optimize the device’s storage by forcing stop, clearing cache or deleting the apps, which have not been used for a long time. The same can be done manually from the “Apps” tab or by tapping on the category of apps in the “Storage” tab.

## 8.7 Sound

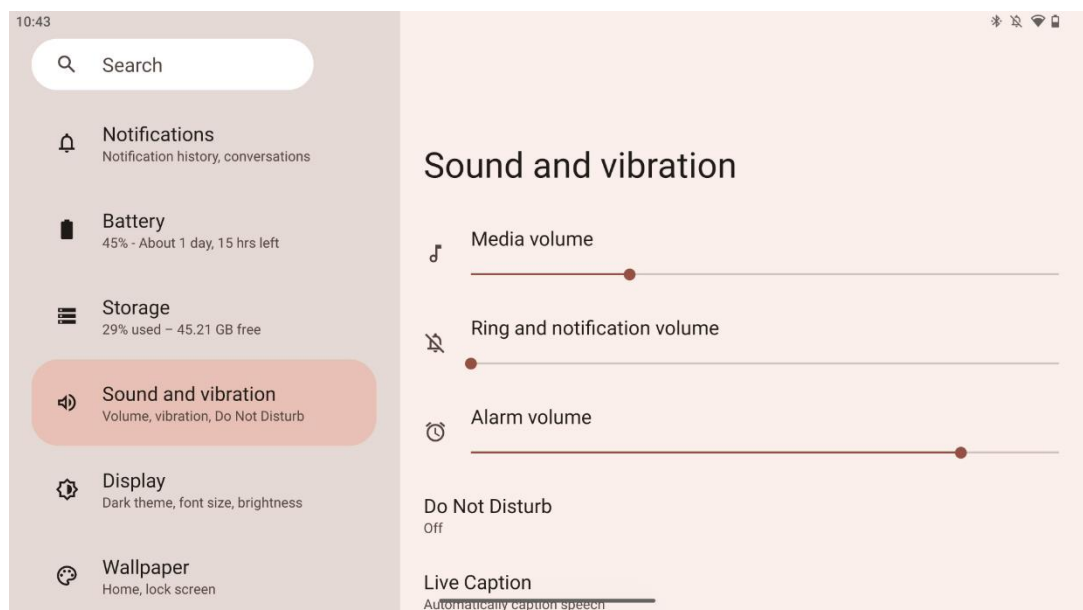

Adjust volume values, enable “Do Not Disturb” mode and setup live captions. Additionally, you can adjust settings for how media is played on your device in the “Media”. Moreover, you can choose the sound for your default notification and alarm sound.

## 8.8 Display

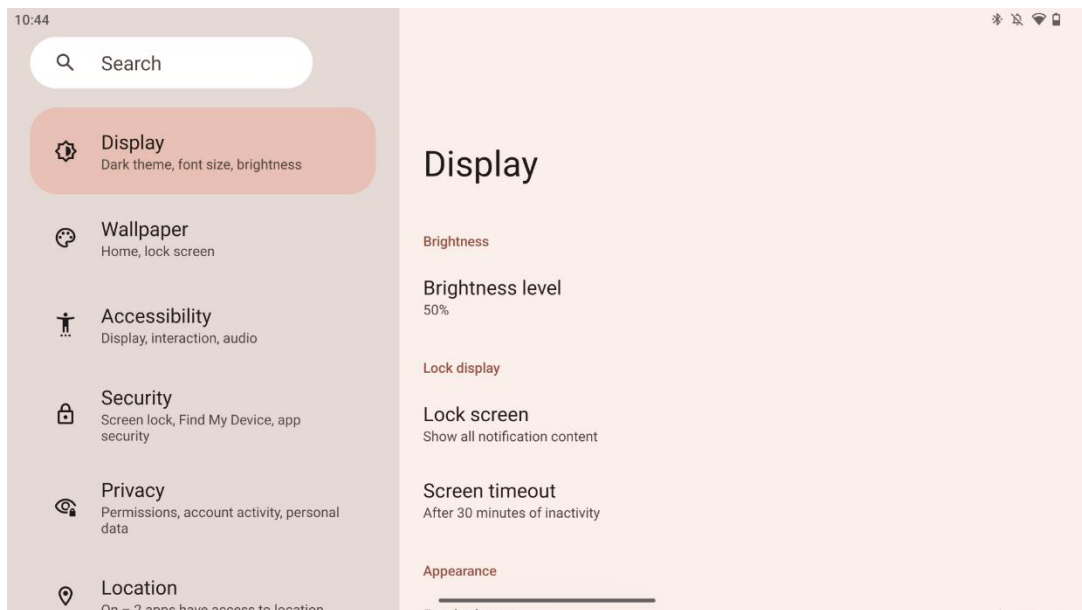

In this tab you can adjust your Display settings:

- **Brightness:** Adjust the brightness level of the Smart Display.
- **Lock display:** Setup the screen's timeout and what can be seen on the lock screen.
- **Appearance:** Adjust the display's size and text as well as enable/disable the dark theme.
- **Colour:** Select colour's preset.
- **Other display controls:** Enable/disable auto-rotate screen, which automatically changes the display's orientation from horizontal to vertical or the other way around depending on the position of the display.

## 8.9 Wallpaper

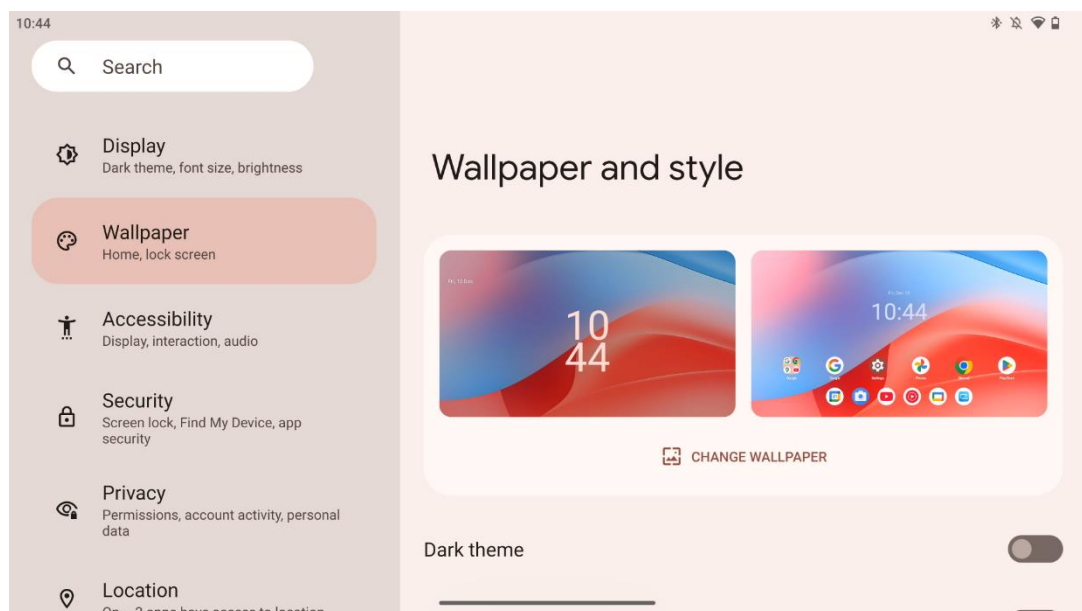

This part of the settings menu allows you to change the wallpaper on the lock and home screens, enable/disable the dark theme and themed icons.

## 8.10 Accessibility

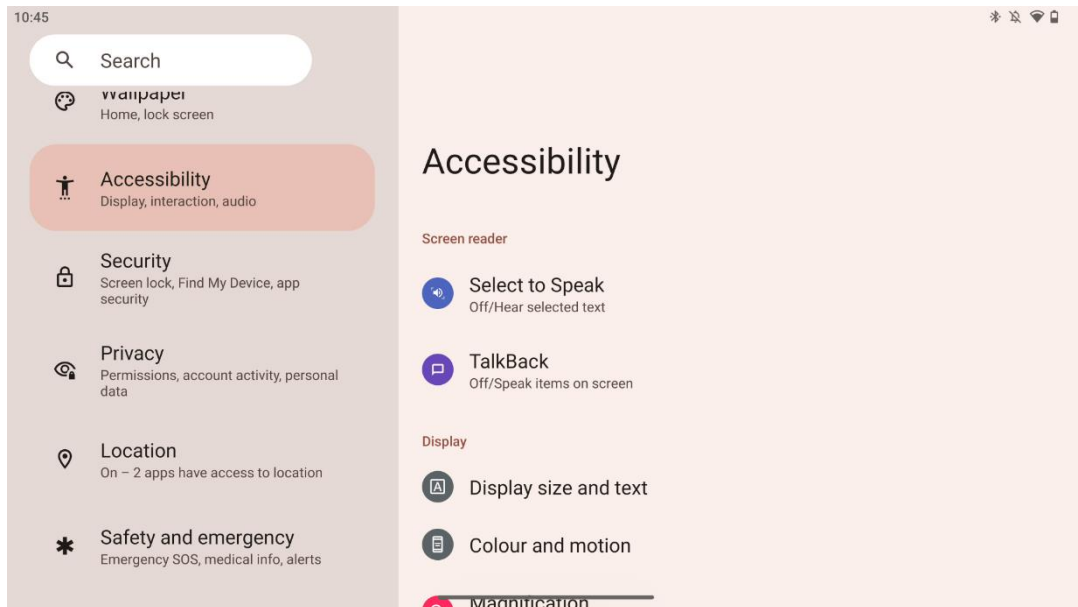

A variety of accessibility options are available for individuals with visual or hearing impairments:

- **Screen reader**
  - **Select to Speak:** Tap specific items on your screen to hear them read or described aloud.
  - **TalkBack:** Provides spoken feedback so that a user can use this device without looking at the screen. This function is particularly useful for people who have difficulty seeing the screen.
- **Display**
  - **Display size and text:** Adjust the font and display size, enable/disable bold and high contrast text.
  - **Colour and motion:** Enable/disable colour inversion and the dark theme. You may setup schedule for the application of the dark theme as well. Additionally, you can enable/disable the colour correction and a shortcut for it. Moreover, here you can enable/disable "Remove animations", which reduces movement on the screen, and make the mouse pointer more noticeable.
  - **Magnification:** Quickly zoom in on the screen to make content larger and adjust the magnification settings.
- **Interaction controls**
  - **Accessibility menu:** This menu provides a large on-screen menu to control the Smart Display. You can lock your device, control volume and brightness, take screenshots, and more.
  - **Timing controls:** Adjust time and delays for gestures and actions.

- **System controls:** Enable/disable auto-rotate screen and select system navigation.
- **Captions**
  - **Live caption:** Detects speech on your device and automatically generates captions.
  - **Caption preferences:** Enable/disable captions and customize caption size and style to make them easier to read.
- **Audio**
  - **Audio description:** Hear a description of what's happening on screen in supported movies and shows.
  - **Hearing aids:** Connect and adjust your hearing aids.
  - **Audio adjustment:** Enable/disable mono audio and adjust audio balance.

## 8.11 Security

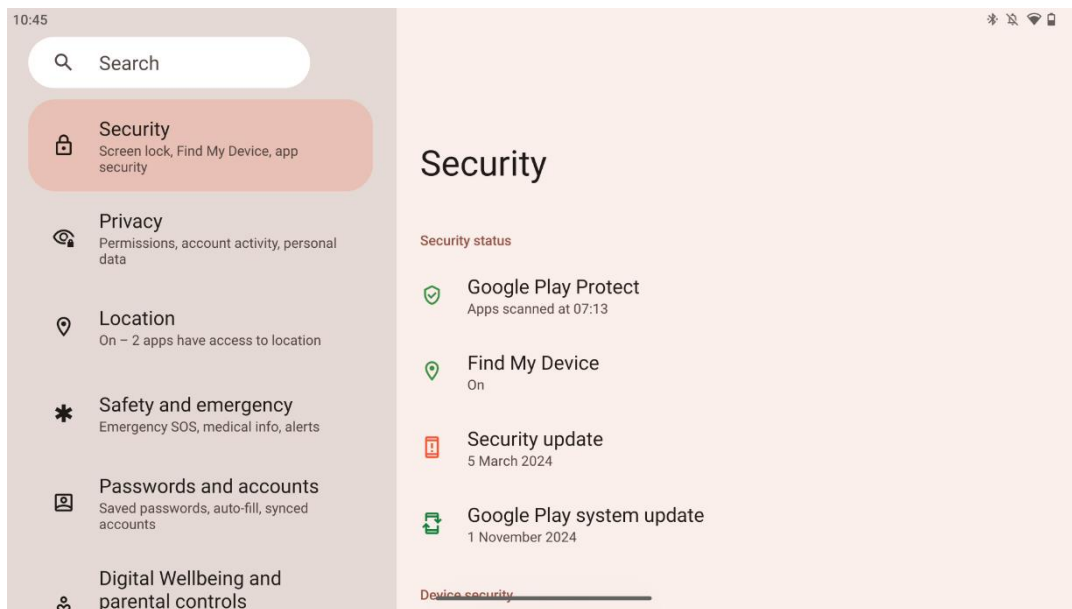

Overview the security status, adjust screen lock settings and more security settings.

## 8.12 Privacy

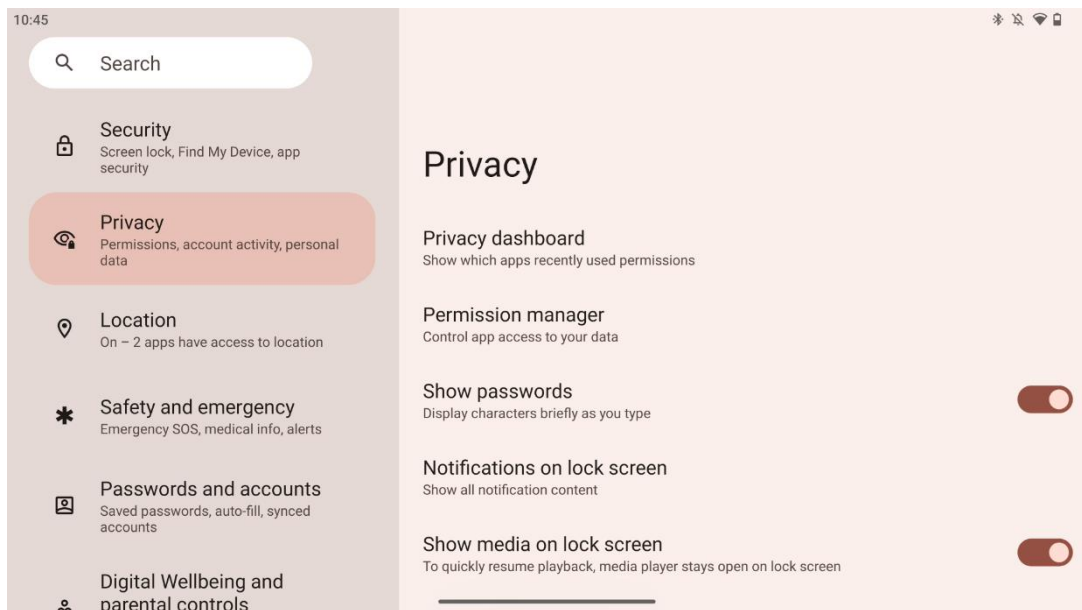

Here you can check privacy related settings:

- **Privacy dashboard:** Show which apps recently used permissions.
- **Permission manager:** Control app access to your data.
- **Show passwords:** Enable/disable displaying all notification content.
- **Notifications on lock screen:** Show all notification content.
- **Show media on lock screen:** Enable/disable quickly resuming playback, meaning that the media player stays open on the lock screen.
- **Android System Intelligence:** Get suggestions based on the people, apps, and content you interact with.
- **App content:** Allows apps to send content to the Android system.
- **Show clipboard access:** Show a message when apps access text, images, or other content you've copied.
- **Autofill service from Google:** Saved passwords, credit cards, addresses.
- **Activity controls:** Choose the activities and info you allow Google to save.
- **Ads:** Manage ads personalization on the Smart Display.
- **Usage & diagnostics:** Share data to help improve Android.

## 8.13 Location

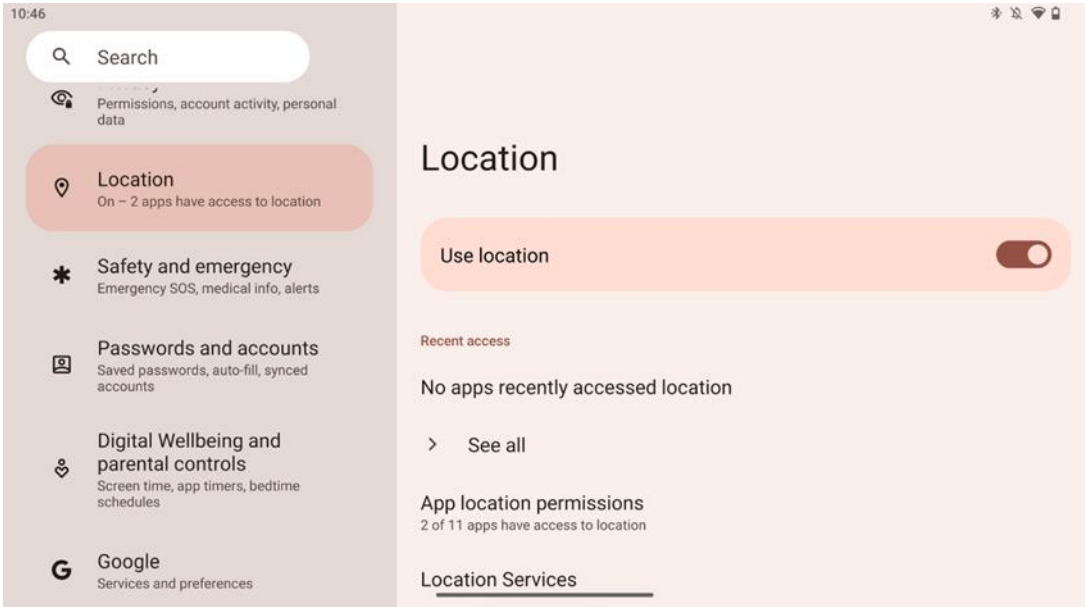

Enable or disable location services on Thomson Go Plus and provide permissions to apps to use your precise location. When location accuracy is on, apps and services get a more accurate location. To do this, Google periodically processes information about device sensors and wireless signals from your device to crowdsource wireless signal locations. These are used without identifying you to improve location accuracy and location-based services, and to improve, provide, and maintain Google’s services based on Google’s and third parties’ legitimate interests to serve users’ needs.

## 8.14 Safety & Emergency

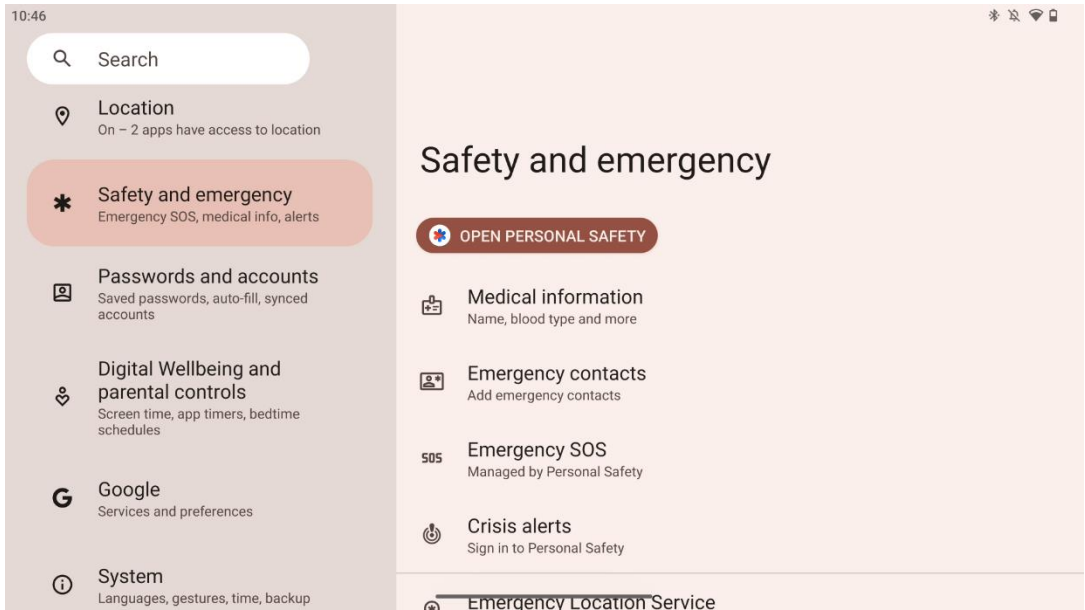

The Safety & Emergency tab on Thomson Go Plus is a centralized feature in the device settings designed to help users prepare for emergencies and access critical safety tools.

- **Medical Information**
  - Store vital details such as:
    - Medical information (allergies, blood type, conditions, etc.)
    - Accessible directly from the lock screen for first responders.
- **Emergency contacts**
  - Add and manage emergency contacts.
- **Emergency SOS**
  - Quickly call emergency services by pressing the power button multiple times.
  - Option to share your real-time location and emergency status with pre-selected contacts.
- **Crisis Alerts**
  - Get notifications for local or global crisis events like natural disasters, government alerts, and more.
- **Emergency Location Services (ELS)**
  - Helps emergency services find your location during a call or text to local emergency numbers.
- **Earthquake Alerts**
  - Provides early warnings about nearby earthquakes using data from your device's sensors.
- **Unknown tracker alerts**
  - Receive notifications, if an unknown tracker is detected nearby. Alerts are deleted after 48 hours.

## 8.15 Passwords & Accounts

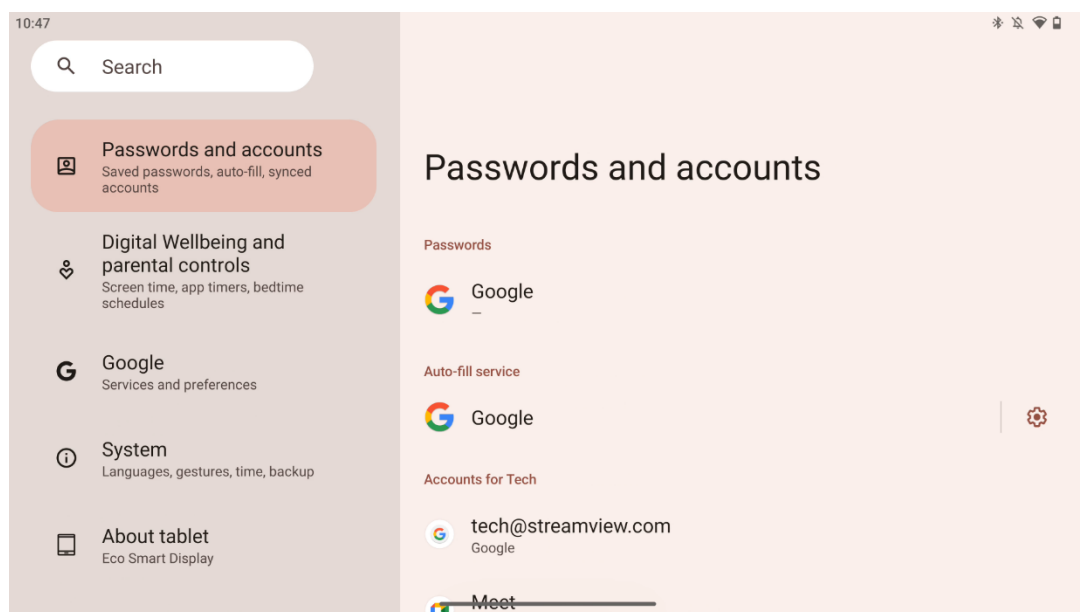



In passwords & accounts you can add, view, edit or delete Google account and their passwords. Simply tap on any account you wish to change and follow on-screen instructions on how to edit your account.

You may enable or disable automatic synchronization of the apps, which provides you an excess to your data on any connected device.

## 8.16 Digital Wellbeing and Parental Controls



The Digital Wellbeing & Parental Controls section in Thomson Go Plus settings is designed to help users manage screen time, maintain a healthy device usage balance, and set controls for children.

Digital Wellbeing provides tools and insights to help you understand and control how you use your device. Key features include:

- **Dashboard**
  - View detailed usage statistics, including:
    - Screen time.
    - App usage.
    - Number of unlocks and notifications received.
- **App limits**
  - Set time limits for apps.
- **Bedtime Mode**
  - Wind down for better sleep by:
    - Activating grayscale mode.
    - Turning on Do Not Disturb to silence notifications.
  - Option to integrate with your alarm or schedule it manually.

- **Focus Mode**
  - Temporarily pause distracting apps to stay focused on tasks.
- **Reduce interruptions**
  - **Manage notifications:** setup notifications according to your preferences.
  - **Do Not Disturb:** Only get notified by important people and apps.

## 8.17 Google Services

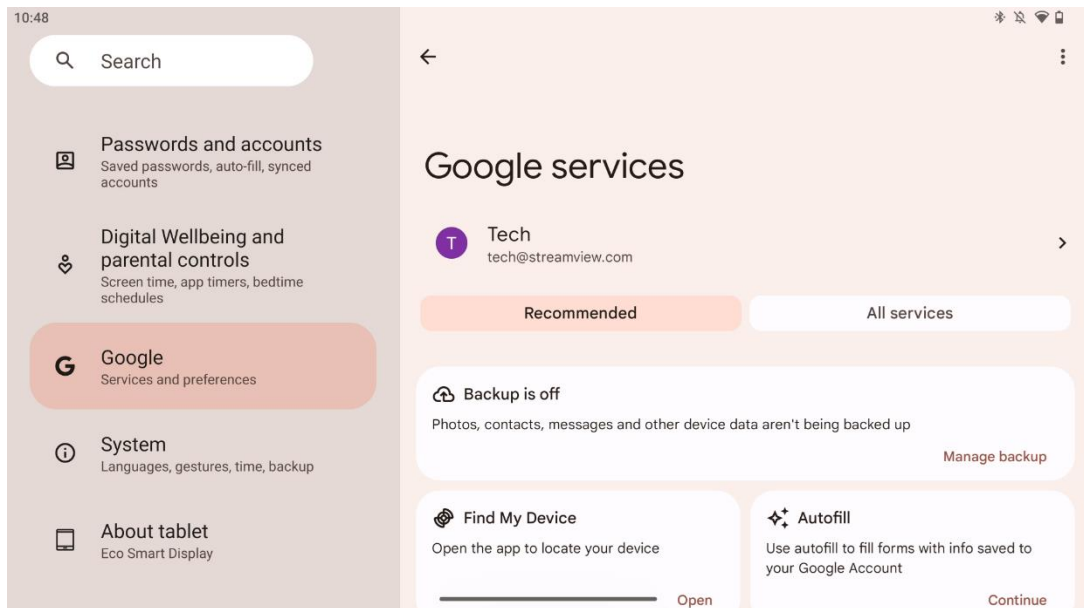

The Google Services tab in the Settings menu on Thomson Go Plus provides access to a range of Google-related settings and tools for managing your account, services, and device functionalities tied to Google's ecosystem.

## 8.18 System

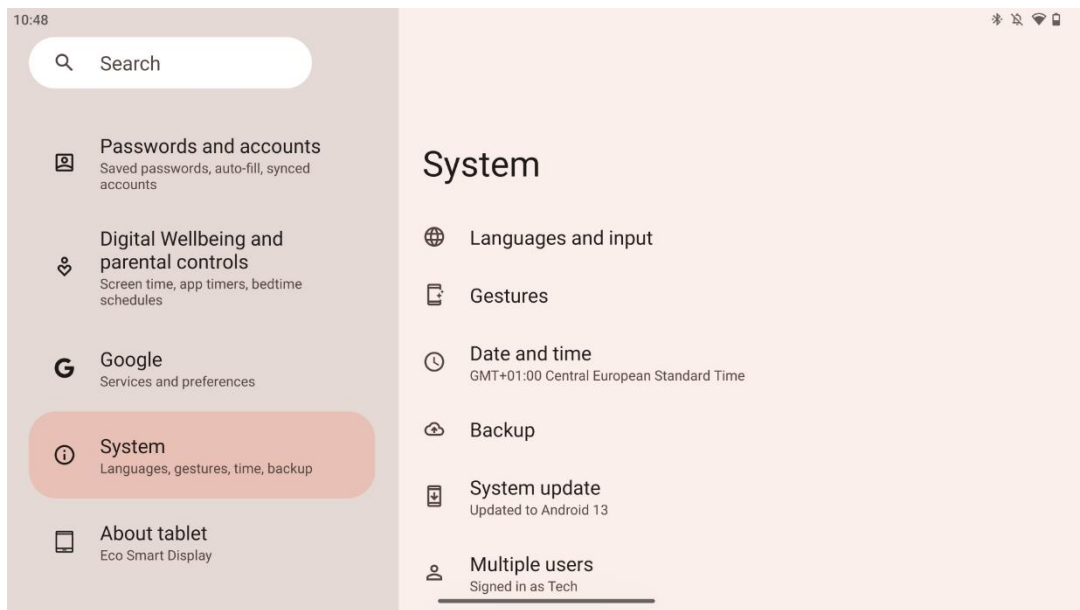

### 8.18.1 Language & Input

#### Preferred Language

- Languages: Select your preferred language for Thomson Go Plus.
- App languages: Select a language for each installed app. App language may differ from the system's language.

#### Keyboards

- On-screen keyboard: Select default Google keyboard or another installed keyboard, which are available in the Google Play Store.
- Physical keyboard: Select physical keyboard, which can be connected via USB cable or Bluetooth, and setup its shortcuts.

#### Speech

- Voice input: Select speech recognition source adjust its settings.
- On-device recognition: Adjust settings for on-device speech recognition.
- Text-to-speech output: Select preferred engine and language, as well as adjust settings of speech rate and pitch.

#### Tools

- Spell checker: Enable/disable spell checker, select default spell checker and preferred language.
- Personal dictionary: Add words to be used in apps such as spell checker.
- Pointer speed: Adjust the movement speed of the pointer.

## 8.18.2 Gestures

### System Navigation

Select the preferred type of navigation between the gesture and 3-button navigation. Additionally, you may adjust sensitivity and enable or disable invoking digital assistant app.

### Press & hold power button

Select a function, between Power menu and Digital assistant, and sensitivity for the press & hold power button.

## 8.18.3 Date & Time

The Date & Time settings menu on Thomson Go Plus allows you to configure how the device handles time zones, date formats, and clock synchronization. It ensures your device displays the correct date and time based on your preferences or location.

### Set time automatically

- Automatically sets the date and time using your network provider.
- Synchronizes your device clock with your current time zone.

### Date

- Manually adjust the current date if automatic settings are disabled.

### Time

- Manually set the current time if not using automatic settings.

### Automatic Time Zone

- Automatically detects and updates the time zone based on your location.
- Uses GPS, Wi-Fi, or mobile network for accuracy.

### Time Zone

- Choose a specific time zone manually if automatic time zone detection is off.

### Use 24-Hour Format

- Toggle between 24-hour time format (e.g., 14:30) and 12-hour format with AM/PM (e.g., 2:30 PM).

Ensures the date and time formats align with your selected language and region settings.

## **8.18.4 Backup**

The Backup feature on Thomson Go Plus helps ensure that your important data is securely saved to your Google Account. It enables you to restore this data when switching to a new device or recovering data after a reset.

Here you can overview the availability of cloud storage for your backup and enable automatic backup.

**Note:** Backup is only available, when the Smart Display is connected to a Wi-Fi network.

In the backup details, you may select specific data related to installed apps, photos and videos, device settings and Google account data that you wish to back up.

## **8.18.5 System Update**

By clicking on this tab, Thomson Go Plus will automatically search for the latest available update. If an update is available, the short update description will appear requesting you to confirm the installation of the update. If you do not want to install the latest update, just ignore the message and return to the previous menu.

## **8.18.6 Multiple Users**

In this part of the menu, you can enable or disable multiple users on the Smart Display. When it is disabled, only one main user can use the device.

When multiple users are allowed, then up to 12 users can be added to the device.

You can add a guest account as well. After the guest completes his usage session and exits the guest mode, all related information will be deleted. You may deactivate automatic deletion of the guest data.

By enabling "Add users from lock screen" you allow anyone who has access to the Smart Display to add users.

## **8.18.7 Reset Options**

The Reset Options menu on Thomson Go Plus provides tools to reset specific settings or the entire device, helping troubleshoot issues or prepare the phone for a new user.

The available options are:

- Reset Wi-Fi, mobile and Bluetooth settings.
- Reset app preferences.

- Erase all data (factory reset).

After resetting Wi-Fi, mobile, Bluetooth settings or app preferences, you will have to enter the required information or account credentials again.

**Note:** By resetting the device to the factory settings will make you lose all information on your device.

## 8.18.8 About

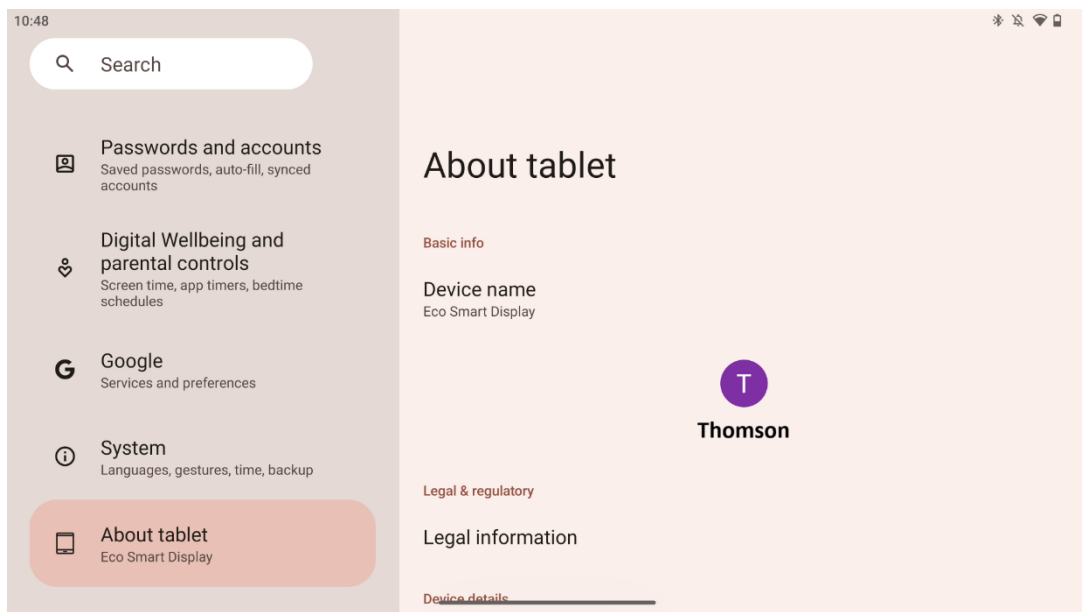

The About Tablet section on an Android tablet provides essential information about the device's hardware, software, and legal details. It's a centralized area to review system specifications, check for updates, and manage device-related settings.

## 9 Troubleshooting

Symptom	Solution
The screen does not display anything; there is no sound, and the indicator does not turn on.	Check whether the product has been turned on. Check whether the power cord has been connected.
The product shuts down suddenly.	It is possible that the internal battery runs out; please connect the power cord. Check whether the [ON/OFF] key on the base is in OFF position. Check whether the auto shutdown function is activated at the set time point. If the battery overheats, the product will shut down automatically for self-protection.
There is no signal when an external HDMI device is connected.	Press the [ON/OFF] key to restart the product. Reconnect the HDMI cable. When the product is on, restart the HDMI device.
There is no sound.	Adjust the volume to a proper level.
Network cannot be connected	Ask the network administrator for the available network IP addresses and other parameters. Check whether the network cable is connected normally. Consult the network service provider.
The network is very slow when playing videos online	Please upgrade your network bandwidth to a higher one. Please try other VOD addresses to get better resources.
The product gets stuck, crashes or cannot be operated.	Press [ON/OFF] button on the base to turn off. Reboot after 1-2min.

## 10 Technical specifications

32UE5M45	
Operating Voltage	100-240 V, 50-60 Hz
DC Adapter Specifications (Output)	19 V/4.74A, 90.06W
Audio (DTS HD)	no
Audio Output Power	2 x 3
Power Consumption (W)	90
Standby Power Consumption (W)	< 0,5
Weight with stand (Kg)	19.2
TV Dimensions LxWxH (with stand) (mm)	731x426x1332
Display	32"/81 cm
Screen resolution	3840x2160
Battery Information	Lithium-ion battery 9000mAh, 11.1V, 94.3Wh

### 10.1 Restrictions

Intended for indoor use.

### 10.2 Licenses

Subject to alterations. In consequence of continuous research and development technical specifications, design and appearance of products may change. Android, Google, Google Play, Android TV, Google Cast, YouTube and other marks are trademarks of Google LLC. Google Assistant is not available in certain languages and countries. Availability of services varies by country and language. Netflix is a registered trademark of Netflix, Inc. Netflix streaming membership required. 4K Ultra HD availability subject to your Netflix subscription plan, Internet service, device capabilities, and content availability. Apple TV is a trademark of Apple Inc., registered in the U.S. and other countries and regions. Disney+ subscription required, see terms at <https://www.disneyplus.com>. ©2025 Disney and its related entities. ©2025 Amazon.com, Inc. or its affiliates. Amazon, Prime Video, and all related marks are trademarks of Amazon.com, Inc. or its affiliates. Amazon Prime membership or Prime Video fees apply. See [primevideo.com/terms](https://primevideo.com/terms) for details. Wi-Fi is a registered trademark of Wi-Fi Alliance®. The terms HDMI and HDMI High-Definition Multimedia Interface, and the HDMI logo are trademarks or registered marks of HDMI Licensing Administrator, Inc. in the United States and other countries. Manufactured under license from Dolby Laboratories. Dolby, Dolby Audio, and the double-D symbol are trademarks of Dolby Laboratories Licensing Corporation. All rights reserved. All product names are trademarks or registered trademarks of their respective owners. ©2025 StreamView GmbH, Franz-Josefs-Kai 1, 1010 Vienna, Austria, [contact@streamview.com](mailto:contact@streamview.com). This product has been manufactured and sold under the responsibility of StreamView GmbH. THOMSON, and the THOMSON logo are trademarks used under license by StreamView GmbH – further information at [www.thomson-brand.com](http://www.thomson-brand.com).