

THOMSON

androidtv



IMPORTANT

Please read this manual carefully before installing and operating the TV.
Keep this manual handy for further reference.

Content

| | |
|--|-----------|
| 1. Safety Information | 3 |
| 1.1. Markings on the product | 3 |
| 1.2. Warning | 4 |
| 1.3. Wall mounting warnings | 4 |
| 1.4. Simplified EU declaration of conformity | 5 |
| 1.5. Apps and performance | 5 |
| 1.6. Data protection | 5 |
| 2. Introduction and feet installation | 5 |
| 2.1. Unpacking and installation | 5 |
| 3. TV buttons and connections | 8 |
| 3.1. TV Button | 8 |
| 3.2. Connections | 9 |
| 4. Remote Control | 10 |
| 5. TV Installation | 11 |
| 6. Initial Setup | 12 |
| 6.1. Language selection | 12 |
| 6.2. Quickly set up your TV with your Android TV phone | 12 |
| 6.3. Google Account Sign in | 13 |
| 6.4. Terms of Service | 15 |
| 6.5. Google Services | 16 |
| 6.6. Play Auto Installs | 17 |
| 6.7. Pairing Bluetooth Remote | 19 |
| 6.8. Select Region/Country | 20 |
| 6.9. Select TV mode (Home/Retail) | 22 |
| 6.10. Chromecast built-in | 22 |
| 6.11. TV Channel Setting | 23 |
| 7. Home | 26 |
| 8. Settings | 27 |
| 9. TV Source Settings | 29 |
| 10. Channels management | 29 |
| 11. Google Play | 30 |
| 12. Troubleshooting | 32 |
| 13. Technical specifications | 32 |
| 13.1. Country restrictions | 33 |
| 13.2. Licences | 33 |



mythomson.com



<https://tv.mythomson.com/en/Support/FAQs/>



<https://tv.mythomson.com/Support/Product-Registration/>

1. Safety Information



In extreme weather (storms, lightning) and long inactivity periods (going on holiday) disconnect the TV set from the mains.

The mains plug is used to disconnect TV set from the electrical network and therefore it must remain readily operable. If the TV set is not disconnected electrically from the mains, the device will still draw power for all situations even if the TV is in standby mode or switched off.

Note: Follow the onscreen instructions for operating the related features.

Important: Please read these instructions fully before installing or operating.

WARNING

This device is intended to be used by persons (including children) who are capable / experienced of operating such a device unsupervised, unless they have been given supervision or instruction concerning the use of the device by a person responsible for their safety.

- Use this TV set at an altitude of less than 2000 meters above the sea level, in dry locations and in regions with moderate or tropical climates.
- The TV set is intended for household and similar general use but may also be used in public places.
- For ventilation purposes, leave at least 10 cm of free space around the TV.
- The ventilation should not be impeded by covering or blocking the ventilation openings with items, such as newspapers, tablecloths, curtains, etc.
- The power cord plug should be easily accessible. Do not place the TV, furniture, etc. on the power cord. A damaged power cord/plug can cause fire or give you an electric shock. Handle the power cord by the plug, do not unplug the TV by pulling the power cord. Never touch the power cord/plug with wet hands as this could cause a short circuit or electric shock. Never make a knot in the power cord or tie it with other cords. When damaged it must be replaced, this should only be done by qualified personnel.
- Do not expose the TV to dripping or splashing of liquids and do not place objects filled with liquids, such as vases, cups, etc. on or over the TV (e.g., on shelves above the unit).
- Do not expose the TV to direct sunlight or do not place open flames such as lit candles on the top of or near the TV.
- Do not place any heat sources such as electric heaters, radiators, etc. near the TV set.
- Do not place the TV on the floor and inclined surfaces.
- To avoid danger of suffocation, keep plastic bags out of the reach of the babies, children and domestic animals.
- Carefully attach the feet / stand to the TV. If the stand is provided with screws, tighten the screws firmly to prevent the TV from tilting. Do not over-tighten the screws.
- Do not dispose of the batteries in fire, or with hazardous or flammable materials.

Warning

- Batteries must not be exposed to excessive heat such as sunshine, fire or the like.
- Excessive sound pressure from earphones or headphones can cause hearing loss.



ABOVE ALL - NEVER let anyone, especially children, push or hit the screen, push anything into holes, slots or any other openings in the case.

1.1. Markings on the product

The following symbols are used on the product as a marker for restrictions and precautions and safety instructions. Each explanation shall be considered where the product bears related marking only. Note such information for security reasons.



Class II Equipment: This appliance is designed in such a way that it does not require a safety connection to electrical earth.



This marking indicates that this product should not be disposed with other household wastes throughout the EU. Please recycle it responsibly to promote the sustainable reuse of material resources. To return your used device, please use the return and collection systems or contact the retailer where the product was purchased.

1.2. Warning

Do not ingest the battery, Chemical Burn Hazard This product or the accessories supplied with the product may contain a coin/button cell battery. If the coin/button cell battery is swallowed, it can cause severe internal burns in just 2 hours and can lead to death.

Keep new and used batteries away from children. If the battery compartment does not close securely, stop using the product and keep it away from children.

If you think batteries might have been swallowed or placed inside any part of the body, seek immediate medical attention.

A television may fall, causing serious personal injury or death. Many injuries, particularly to children, can be avoided by taking simple precautions such as:

- ALWAYS use feet or stands or mounting methods recommended by the manufacturer of the television set.
- ALWAYS use furniture that can safely support the television set.
- ALWAYS ensure the television set is not overhanging the edge of the supporting furniture.
- ALWAYS educate children about the dangers of climbing on furniture to reach the television set or its controls.
- ALWAYS route cords and cables connected to your television so they cannot be tripped over, pulled or grabbed.
- NEVER place a television set in an unstable location.
- NEVER place the television set on tall furniture (for example, cupboards or bookcases) without anchoring both the furniture and the television set to a suitable support.
- NEVER place the television set on cloth or other materials that may be located between the television set and supporting furniture.
- NEVER place items that might tempt children to climb, such as toys and remote controls, on the top of the television or furniture on which the television is placed.
- The equipment is only suitable for mounting at heights ≤ 2 m.

If the existing television set is going to be retained and relocated, the same considerations as above should be applied.

Apparatus connected to the protective earthing of the building installation through the MAINS connection or through other apparatus with a connection to protective earthing – and to a television distribution system using coaxial cable, may in some circumstances create a fire hazard. Connection to a television distribution system has therefore to be provided through a device providing electrical isolation below a certain frequency range (galvanic isolator).

1.3. Wall mounting warnings

- Read the instructions before mounting your TV on the wall.
- The wall mount kit is optional. You can obtain from your local dealer, if not supplied with your TV.
- Do not install the TV on a ceiling or on an inclined wall.
- Use the specified wall mounting screws and other accessories.

Tighten the wall mounting screws firmly to prevent the TV from fall. Do not over-tighten the screws.

Figures and illustrations in this user manual are provided for reference only and may differ from the actual product appearance. Product design and specifications may be changed without notice.

| | W (mm) | H (mm) | D (mm) | L (mm) |
|-----|--------|--------|--------|--------|
| 24" | 100 | 100 | 4 (M4) | 6 |
| 32" | 100 | 100 | 6 (M6) | 8 |
| 40" | 200 | 200 | 6 (M6) | 8 |
| 43" | 200 | 200 | 6 (M6) | 8 |
| 50" | 200 | 200 | 6 (M6) | 8 |
| 55" | 200 | 200 | 6 (M6) | 10 |
| 65" | 200 | 200 | 6 (M6) | 10 |
| 75" | 400 | 200 | 8 (M8) | 12 |
| 85" | 500 | 400 | 8 (M8) | 12 |

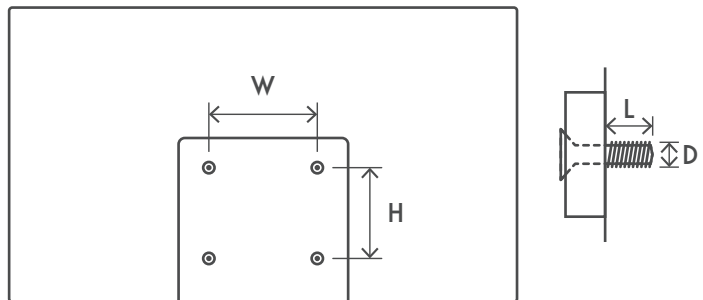

1.4. Simplified EU declaration of conformity

Hereby, StreamView declares that the radio equipment type product device Smart TV is complying with Directive 2014/53/EU.

1.5. Apps and performance

Download speed depends on your Internet connection. Some apps might not be available in your country or region. Netflix is available in selected countries. Streaming membership is required. More information at www.netflix.com. The availability of the language for Google Assistant depends on Google Voice Search support. By default the SW of the Thomson TVs is without PVR (recording) function. You can download and install the PVR function of your choice on the following link. Additional fees may apply.

1.6. Data protection

The application providers and the providers of the services may collect and use technical data and related information, including but not limited to technical information about this device, system and application software and peripherals. They may use such information to improve products or to provide services or technologies, which do not personally identify you. Additionally, some third-party services, already provided in the device or installed by you after purchasing the product, may request a registration with your personal data. Some services may collect personal data even without providing additional warnings. StreamView cannot be held liable for a possible breach of data protection by third-party services.

2. Introduction and feet installation

Thank you for choosing our product. You'll soon be enjoying your new TV. Please read these instructions carefully. They contain important information which will help you get the best from your TV and ensure safe and correct installation and operation.

2.1. Unpacking and installation

Take out the feet and the TV from the packing and put the feet onto a table or any other even surface.

- Use a flat and firm table or similar even surface that can support the weight of the TV.
- Do not hold the screen panel part.
- Make sure not to scratch or break the TV.
- The feet are marked left and right.

24" - 55"

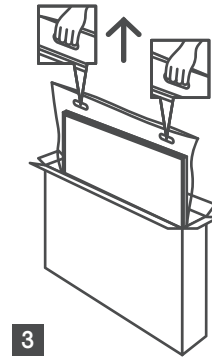
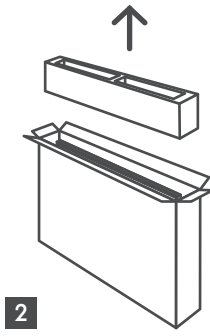
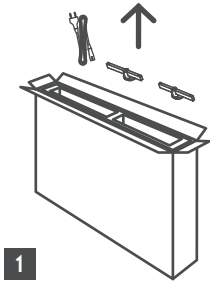

65" - 85" 

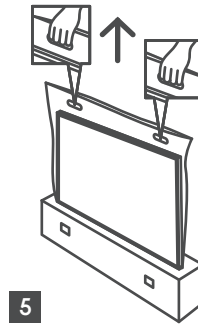
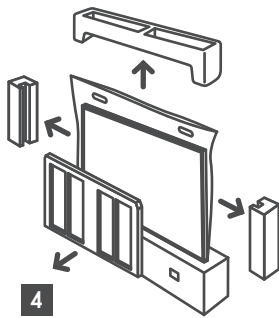
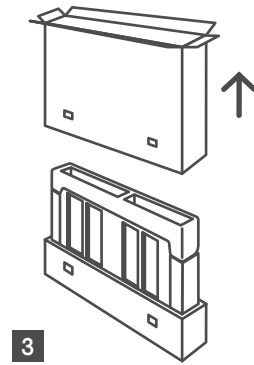
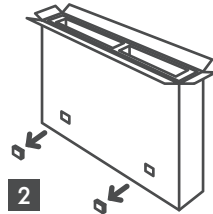
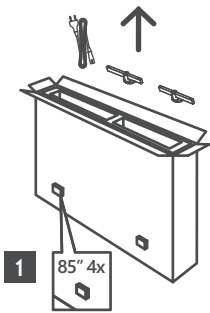

*For 24" and 32" TV models two different feet installation positions are available.

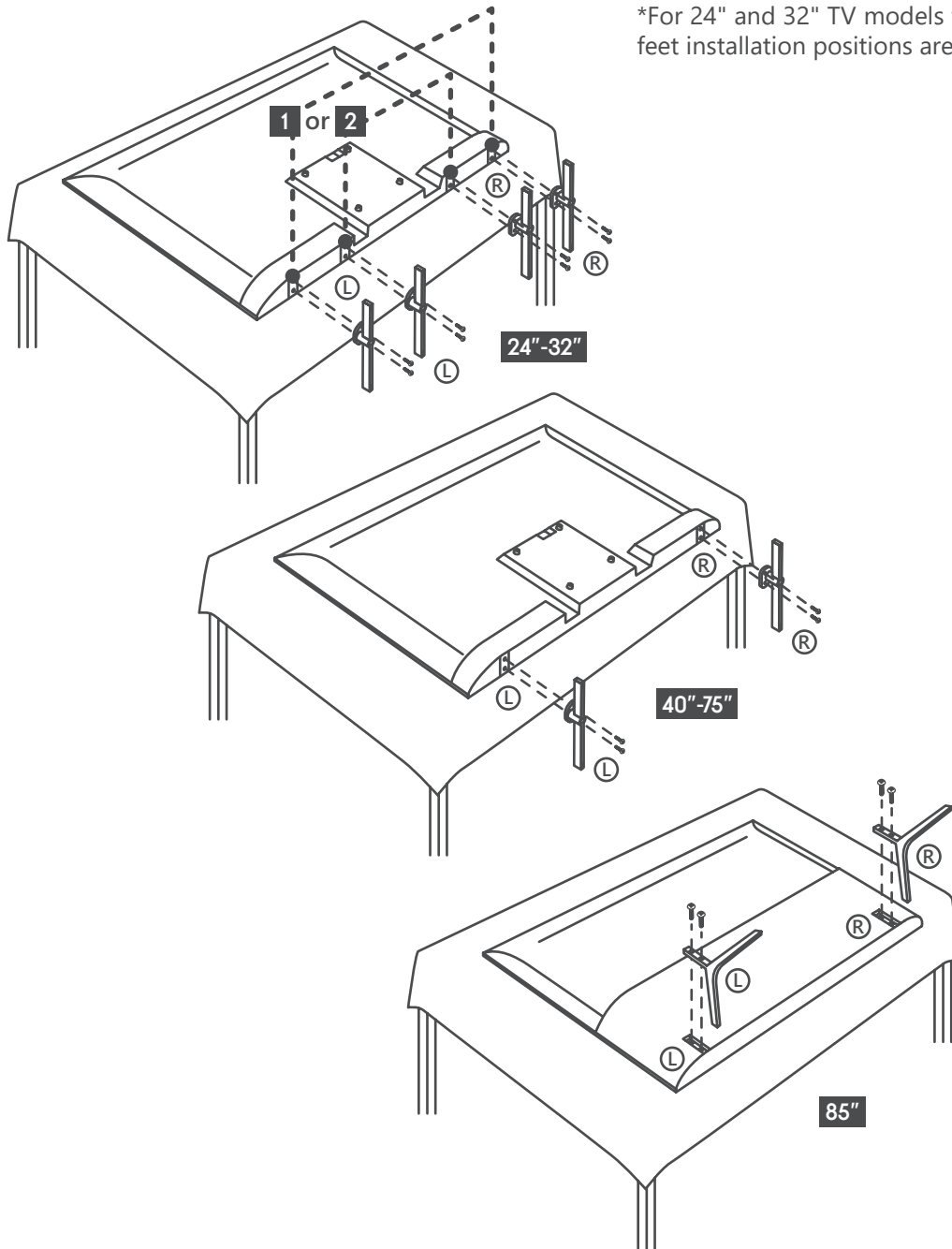

Your TV is also prepared for a VESA-compliant wall mount bracket. If it is not supplied with your TV, contact your local dealer to purchase the recommended wall mount bracket.

Holes and measurements for wall mount bracket installation:

| | W (mm) | H (mm) | D (mm) | L (mm) |
|-----|--------|--------|--------|--------|
| 24" | 100 | 100 | 4 (M4) | 6 |
| 32" | 100 | 100 | 6 (M6) | 8 |
| 40" | 200 | 200 | 6 (M6) | 8 |
| 43" | 200 | 200 | 6 (M6) | 8 |
| 50" | 200 | 200 | 6 (M6) | 8 |
| 55" | 200 | 200 | 6 (M6) | 10 |
| 65" | 200 | 200 | 6 (M6) | 10 |
| 75" | 400 | 200 | 8 (M8) | 12 |
| 85" | 500 | 400 | 8 (M8) | 12 |

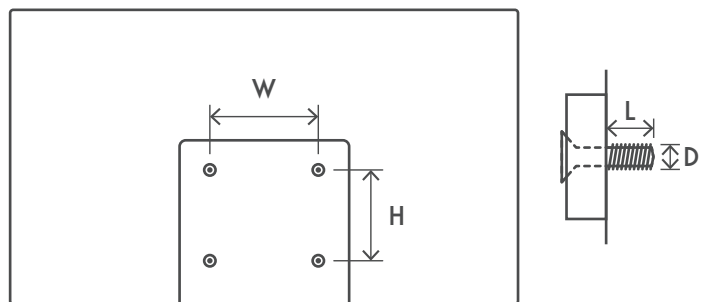

3. TV buttons and connections

Caution:



If you want to connect a device to the TV, make sure that both the TV and the device are turned off before making any connection. After the connection is done, you can turn on the units and use them.



Do not touch or be close to the HDMI, USB terminals, and prevent electrostatic discharge to disturb these terminals while in USB operation mode, or it will cause the TV to stop working or abnormal status.

Note:

The actual position and arrangement of ports may be different from model to model.

3.1. TV Button

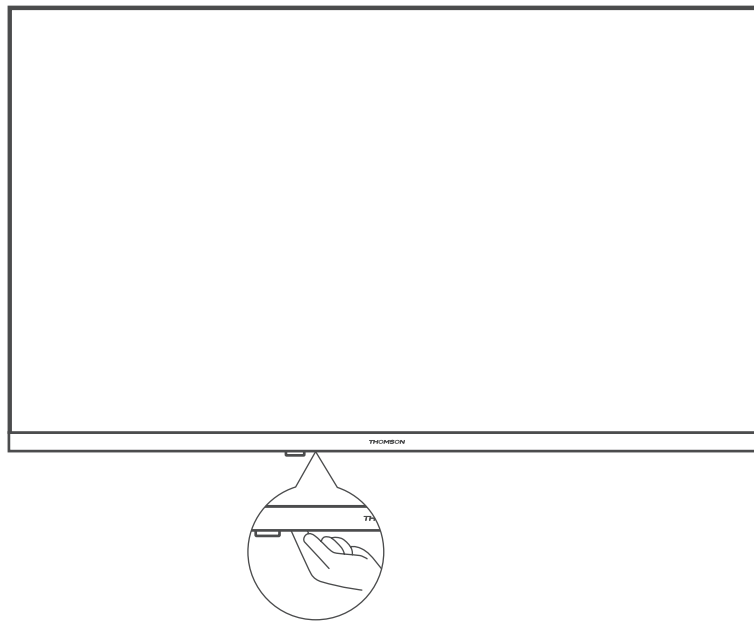

Press this button in standby mode to turn on / off the TV

3.2. Connections

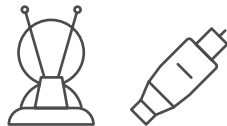
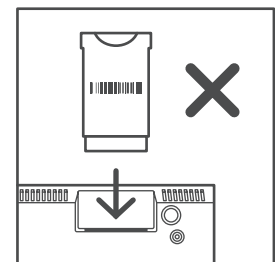
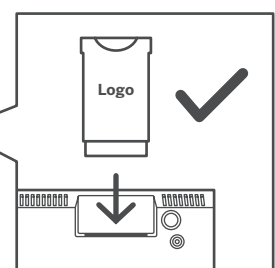
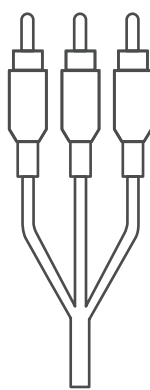
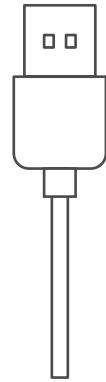
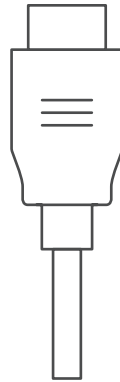
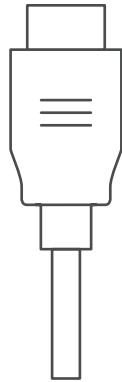
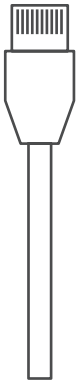
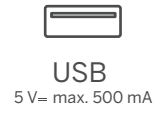

CI+ Modul

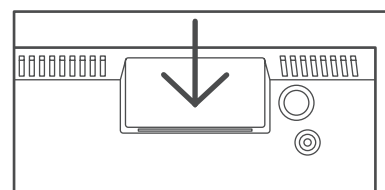

Note: If the model has a CI card slot on its top, a silicone plug for the CI card slot can be found in the accessory bag (for models without CI card slot, there is no such silicone plug), please insert the silicone plug in to the slot when the CI card is not in use.

4. Remote Control

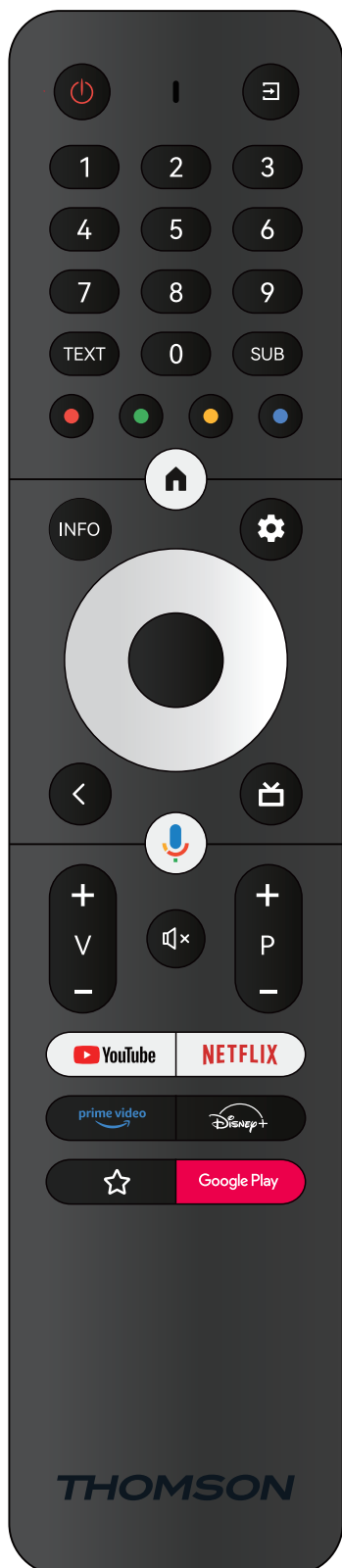

| | |
|------|---|
| | Standby: Quick Standby / Standby / On |
| | Source/Input: Closes and exits from Live TV Settings menus, exits from any running application or menu or OSD banner, switches to last set source; Selecting the inputs of the TV. |
| 0-9 | Numeric buttons: Switches the channel in Live TV mode, enters a number or a letter in the text box on the screen |
| TEXT | Text: Opens and closes teletext (where available in Live TV mode) |
| SUB | Subtitles: Turns subtitles on and off (where available) |
| | Coloured Buttons: Follow the on-screen instructions for coloured button functions |
| | Home: Opens the Home Screen |
| INFO | Info: Displays information about on-screen content |
| | Settings: Displays Live TV Settings menu (in Live TV mode), displays available setting options such as sound and picture; In case you have purchased a SW with PVR (recording) function: upon pressing and holding setting button for 5 seconds, an additional keyboard with more functions opens in the TV Live app. |
| | Directional buttons: Navigates menus, setting options, moves the focus or cursor etc., sets record time and displays the subpages in Live TV-Teletext mode when pressed Right or Left. Follow the on-screen instructions |
| | OK: Confirms selections, enters sub-menus, views channel list (in Live TV mode). Press 5 sec. to switch the backlight of the remote control on/off |
| | Back/Return: Returns to previous menu screen, goes one step back, closes open windows, closes teletext (in Live TV-Teletext mode). Exits the playback of multimedia files and returns to the MMP (Multi Medi Player) overview menu / Remote pairing |
| | Electronic program guide |
| | Microphone: Activates the Google Assistant |
| | Volume +/-: Control the Sound Volume of the TV. |
| | Mute: Completely turns off the volume of the TV |
| | Programme +/-: Zapping the single TV/radio channels. Scroll the channel list page by page when the channel list is displayed on the TV screen. |
| | YouTube: Launches the YouTube application |
| | Netflix: Launches the Netflix application |
| | Prime Video: Launches the Prime Video application |
| | Disney +: Launches the Disney + application |
| | Favourite application: Determination of the Favourite application. Selection of the Favourite application. |
| | Google Play: Launches the Google Play application |
| | Remote Control pairing: Simultaneously pressing the Back button and the V- button, activates the pairing mode of the Remote control. |

5. TV Installation

Set your TV

To put your TV on a firm place which can bear the weight of the TV. To avoid danger, please do not position the TV near water or heating places (such as light, candle, heating machine), do not block the ventilation at the back of the TV.

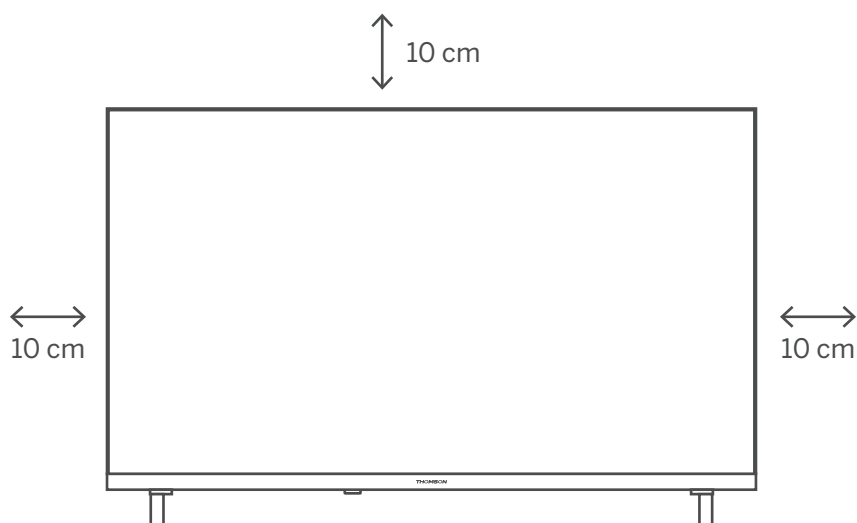

Connect antenna and power

1. Connect the antenna cable to the antenna socket on the back of the TV.
2. Plug in the power cord of your TV (AC 100-240 V~ 50/60 Hz). The TV enters standby mode (red light).
3. Turn on your TV by pressing the power button of the TV or the power button on the remote control.
4. In case you have purchased a TV model with 12 Volt adapter included - use the right port to connect the adapter to the TV set

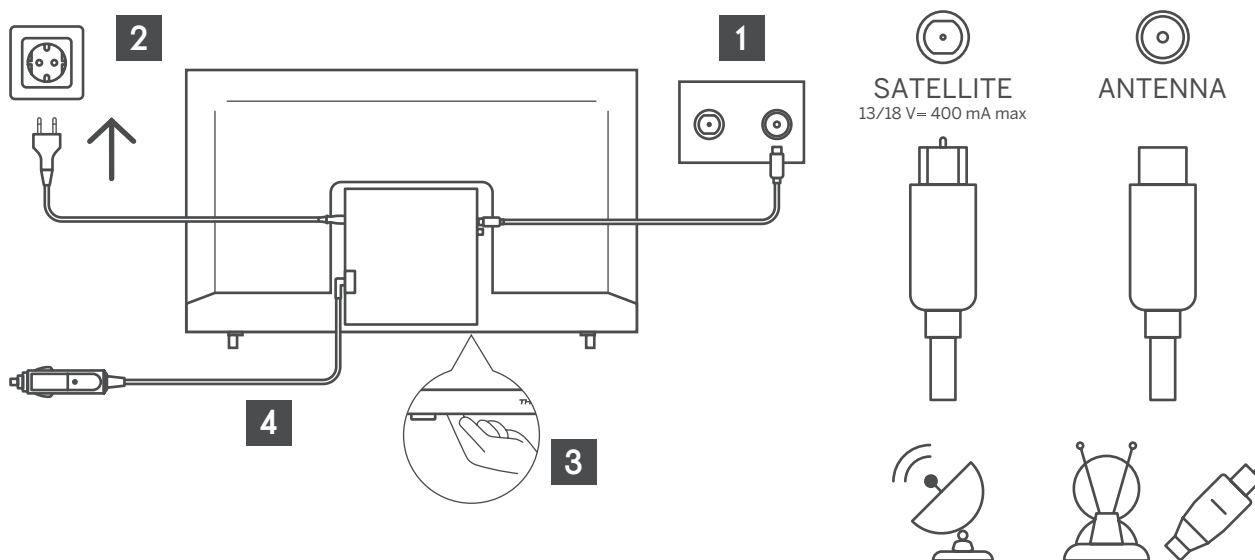

6. Initial Setup

For the first initial setup, in-screen setup wizard will guide you through setting up your TV. Please follow the guide to setup your TV correctly.

6.1. Language selection

Use the up/down buttons to select the system language, then press OK to confirm.

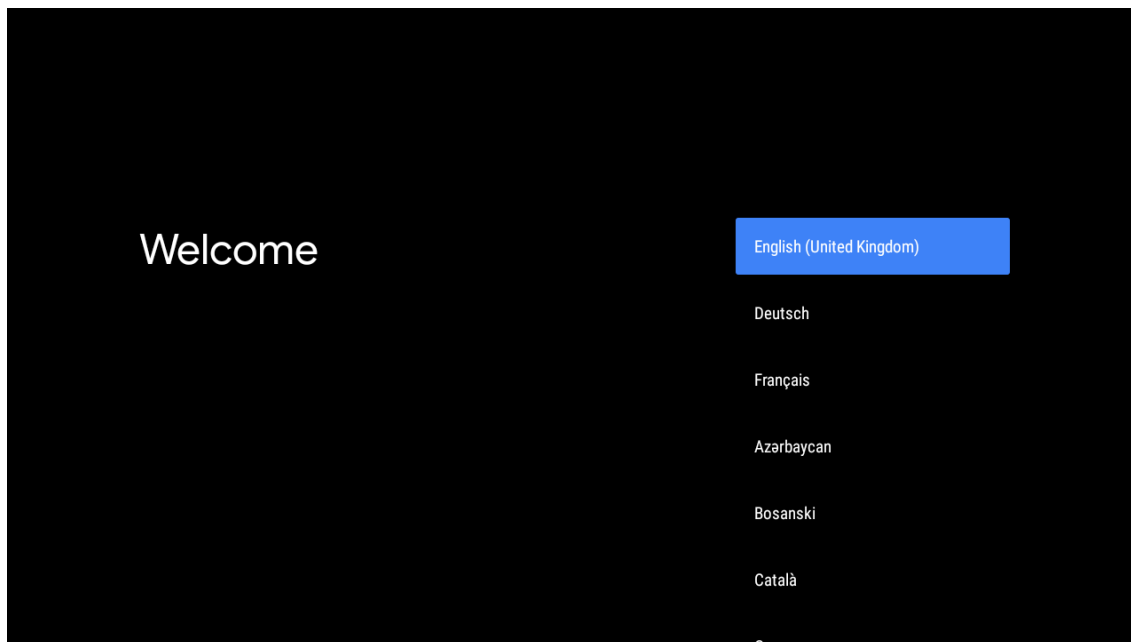

6.2. Quickly set up your TV with your Android TV phone

To connect your Android Smartphone to your TV. Select "Continue".

- On your Android Phone, open the pre-installed app "Google"
- Type or say "Ok Google, set up my device"
- Tap the model name on the list
- Note: Press "BACK" to cancel. If you just want to use your TV normally, please select "Skip".

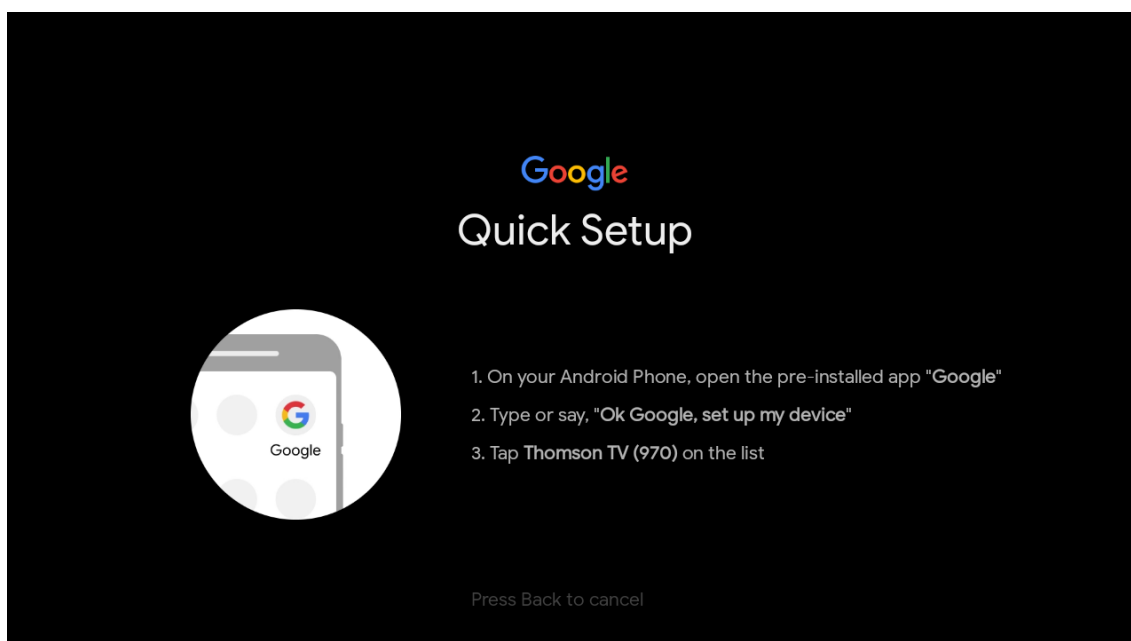

Press the up/down buttons to select WiFi you wish to connect, enter the password and confirm to connect. If you select Skip, you can set your network later in the settings menu.

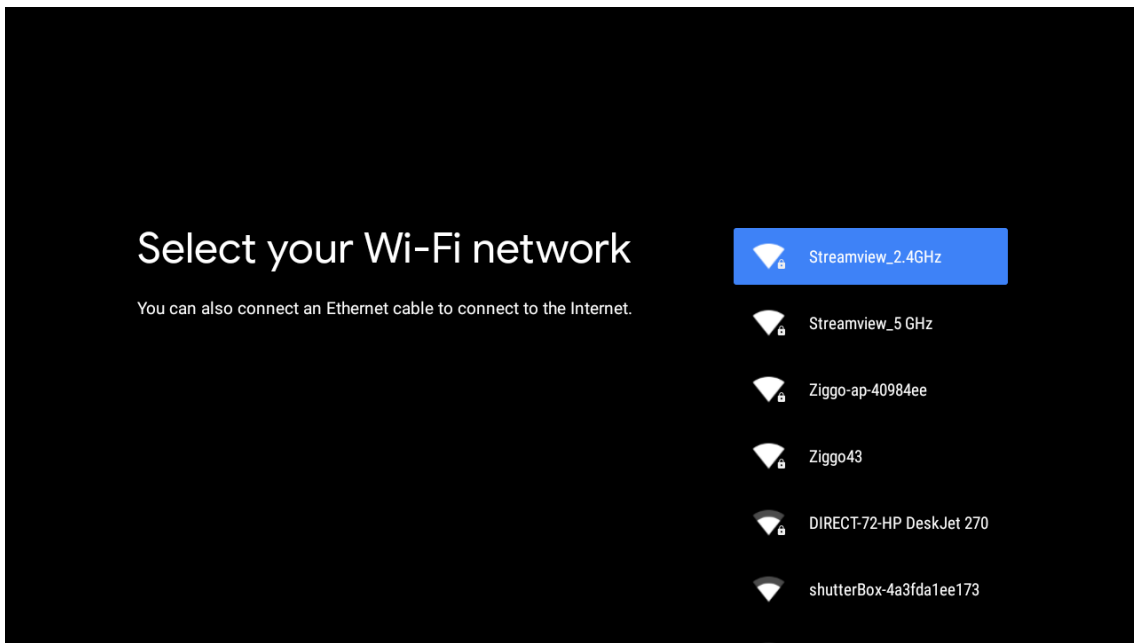

6.3. Google Account Sign in

Sign in to get new apps, recommendations, movies, and more from Google.

Use the remote control to enter your password and sign in to your Google Account.

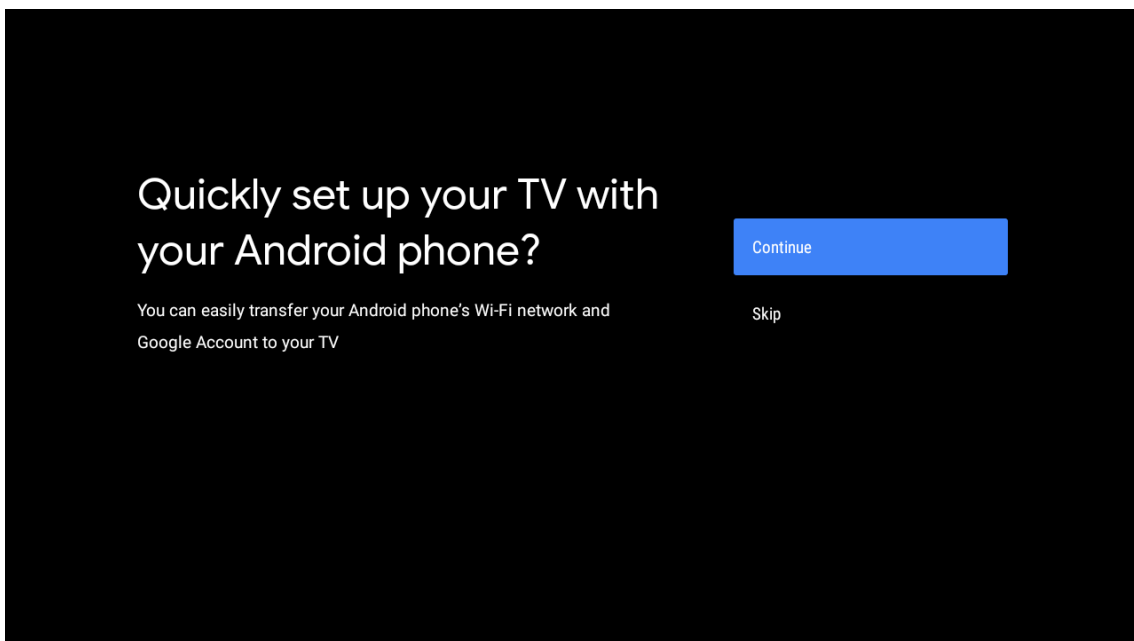



Make the most of your TV

Sign in to get new apps, recommendations, movies, the Assistant and more from Google.

Sign In

Skip



Get personalised recommendations from apps such as YouTube

Google

Sign in

Use your Google Account

Email or phone

[Forgot email?](#)

[Create account](#)

Next

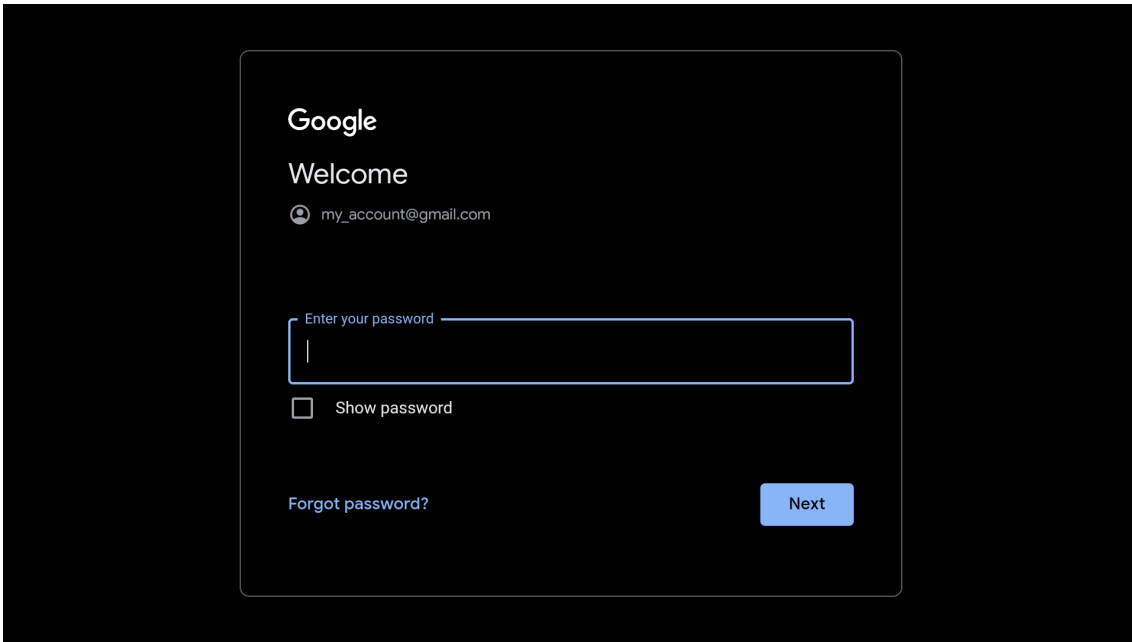

6.4. Terms of Service

By accepting the Google Terms of Service to improve the product experience. Select "Accept" to proceed with this condition.

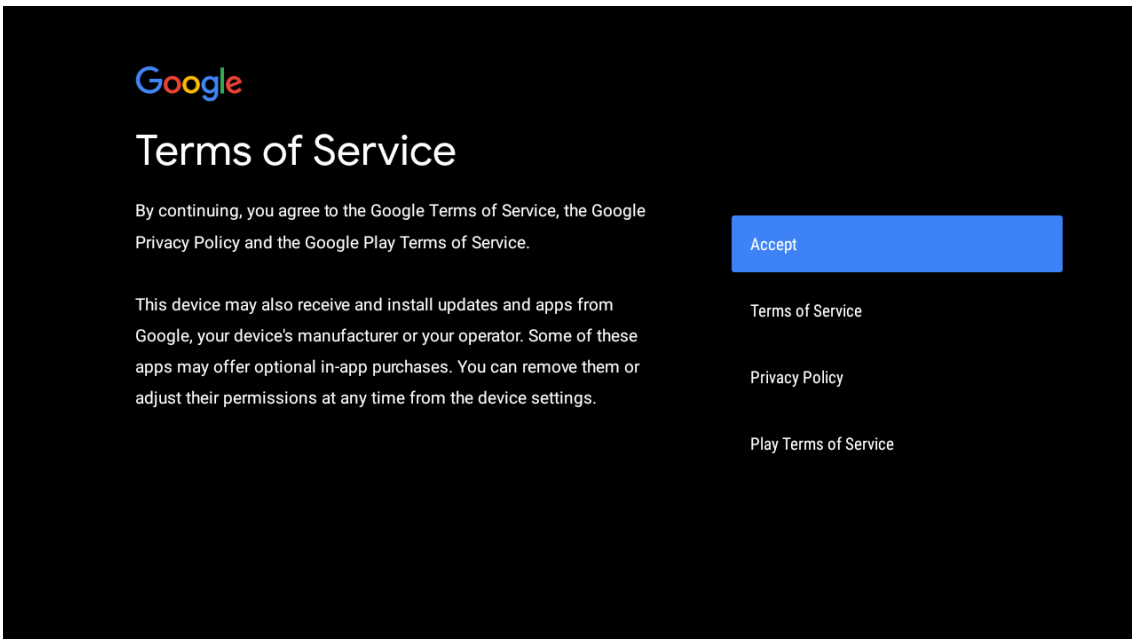

Network privacy policy

The processing of personal data to the extent strictly necessary and proportionate for the purposes of ensuring network and information security, i.e. the ability of a network or an information system to resist, at a given level of confidence, accidental events or unlawful or malicious actions that compromise the availability, authenticity, integrity and confidentiality of stored or transmitted personal data, and the security of the related services offered by, or accessible via, those networks and systems, by public authorities, by computer emergency response teams (CERTs), computer security incident response teams (CSIRTs), by providers of electronic communications networks and services and by providers of security technologies and services, constitutes a legitimate interest of the data controller concerned. This could, for example, include

ACCEPT

DECLINE

6.5. Google Services

Select "Accept" to confirm if you want your location identified on your Android TV and agree to automatically send diagnostic information to Google to help improve your Google experience.



Google services

Select each to learn more about each service, such as how to turn it on or off later. Data will be used according to Google's Privacy Policy.

Click 'Accept' to confirm your selection of these Google services settings.

Select one below

Accept

location

Allow Google and apps with your permission to use location estimated from Wi-Fi. Google may collect location data periodically and use this data in an anonymous way to improve location accuracy and location-based services



Help improve Android

Automatically send diagnostic information to Google



Services and your privacy

Google Assistant sends services that you talk to a unique code

6.6. Play Auto Installs

Select install or un-install the recommended apps and Google apps by using this process. Select "Continue" to the next page.

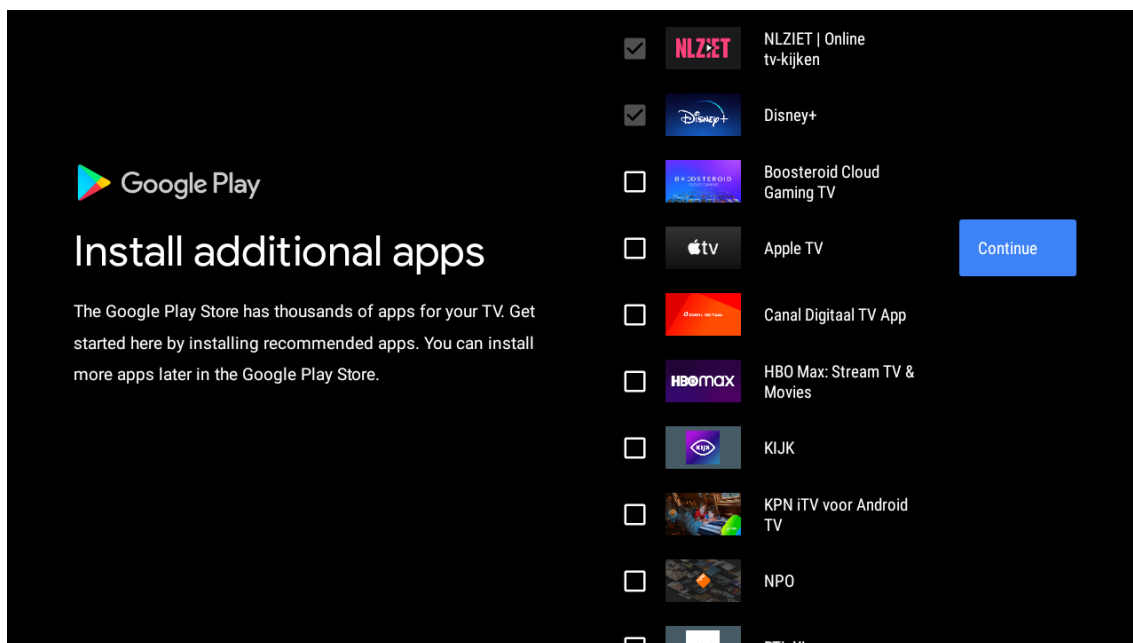

Information screens will now appear, you can scroll through setups by pressing "RIGHT" directional button to continue.

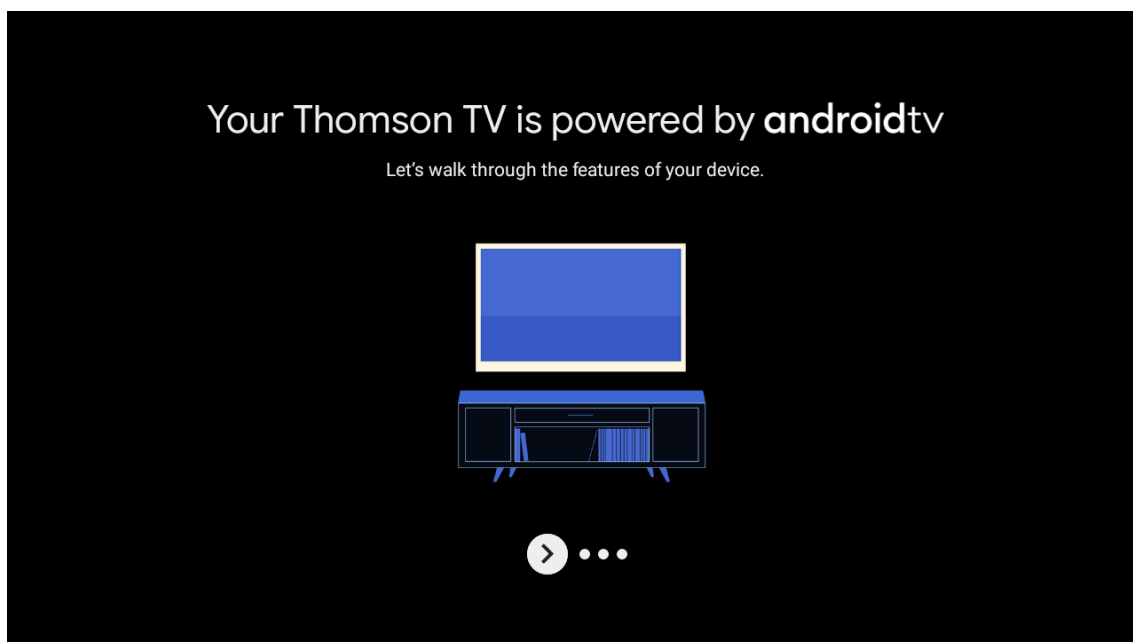

Get apps from Google Play

The Google Play Store offers apps that you're sure to love. Watch shows, stream live sports, play games and more.



Talk to the Google Assistant

After setup, press the mic button on your remote to quickly find the latest blockbuster, check the score of the big game or control your TV.



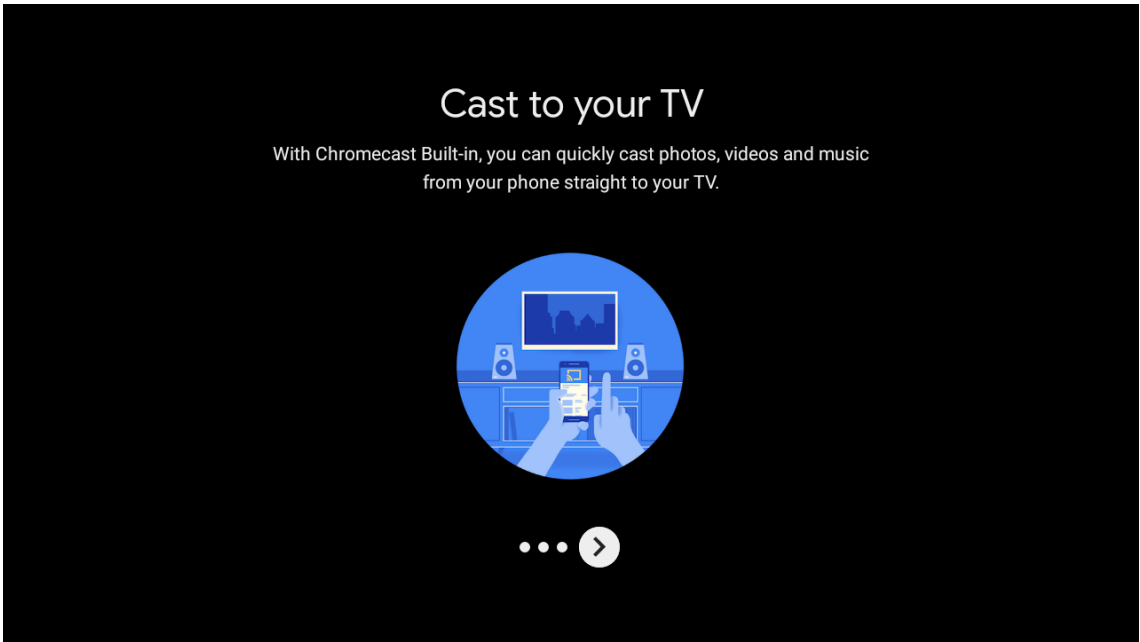

6.7. Pairing Bluetooth Remote

- Press BACK and VOL - simultaneously on remote control to enter the Bluetooth pairing mode. The indicator light on remote control will flash when starting the pairing mode.
- Press BACK to skip the pairing mode.

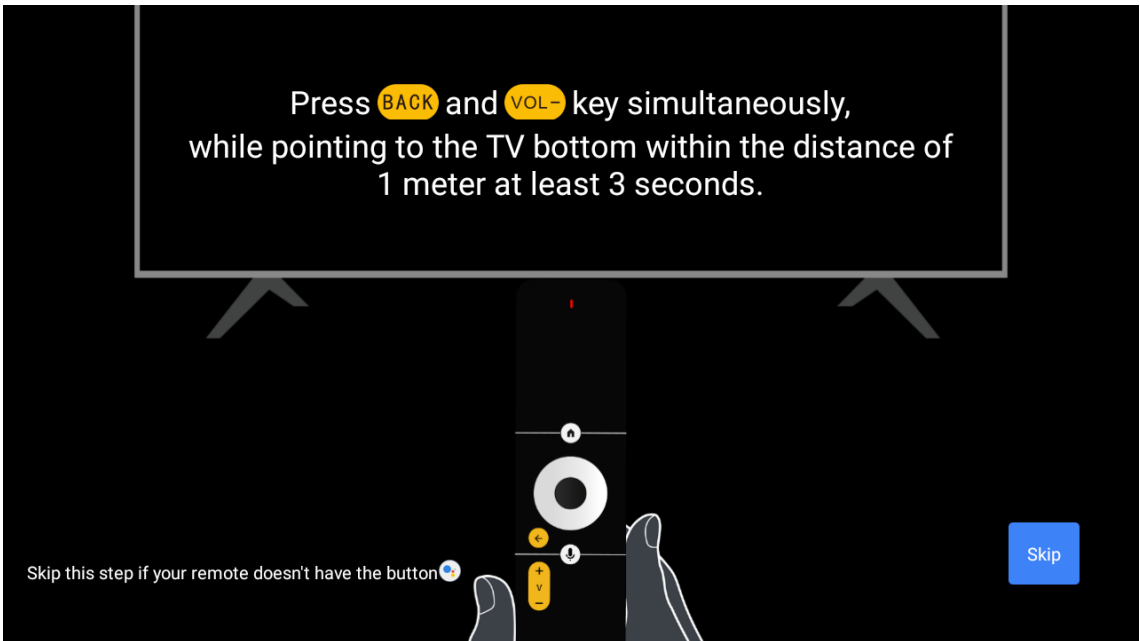

6.8. Select Region/Country

Select the country you are using the device in with the directional buttons, then press OK to confirm.

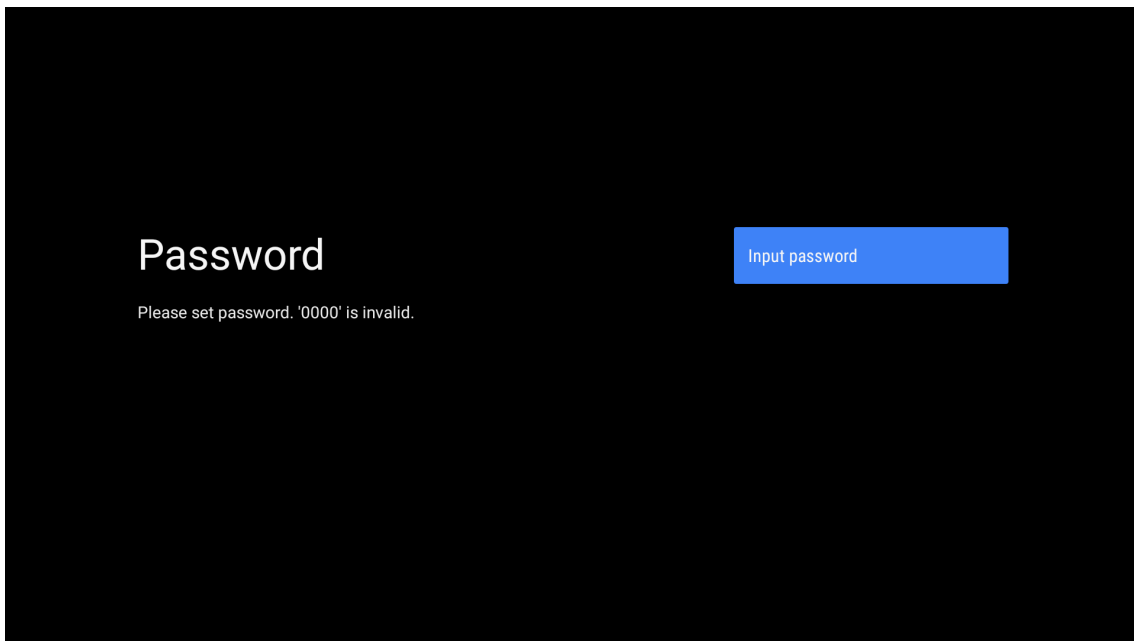
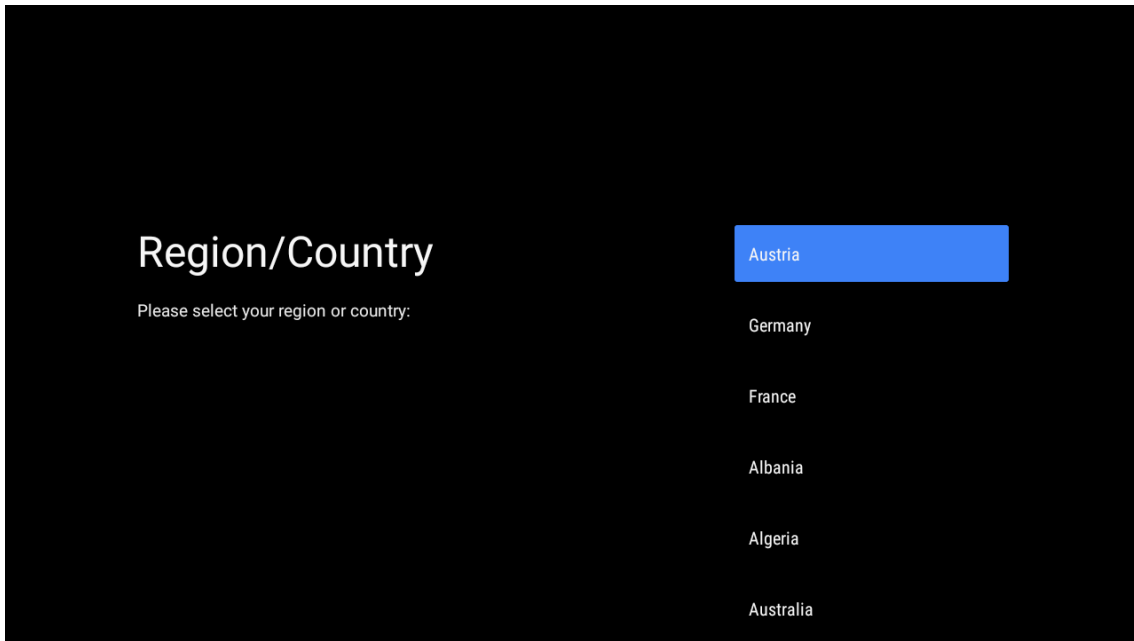

Input password

New password

| | | | |
|---|---|---|---|
| 1 | 2 | 3 | ⌫ |
| 4 | 5 | 6 | 0 |
| 7 | 8 | 9 | ✓ |

Confirm password

Confirm password

| | | | |
|---|---|---|---|
| 1 | 2 | 3 | ⌫ |
| 4 | 5 | 6 | 0 |
| 7 | 8 | 9 | ✓ |

6.9. Select TV mode (Home/Retail)

Please be sure in this step, select "Home" if you are using this TV for use at home. Make sure to confirm once you have selected "Home".

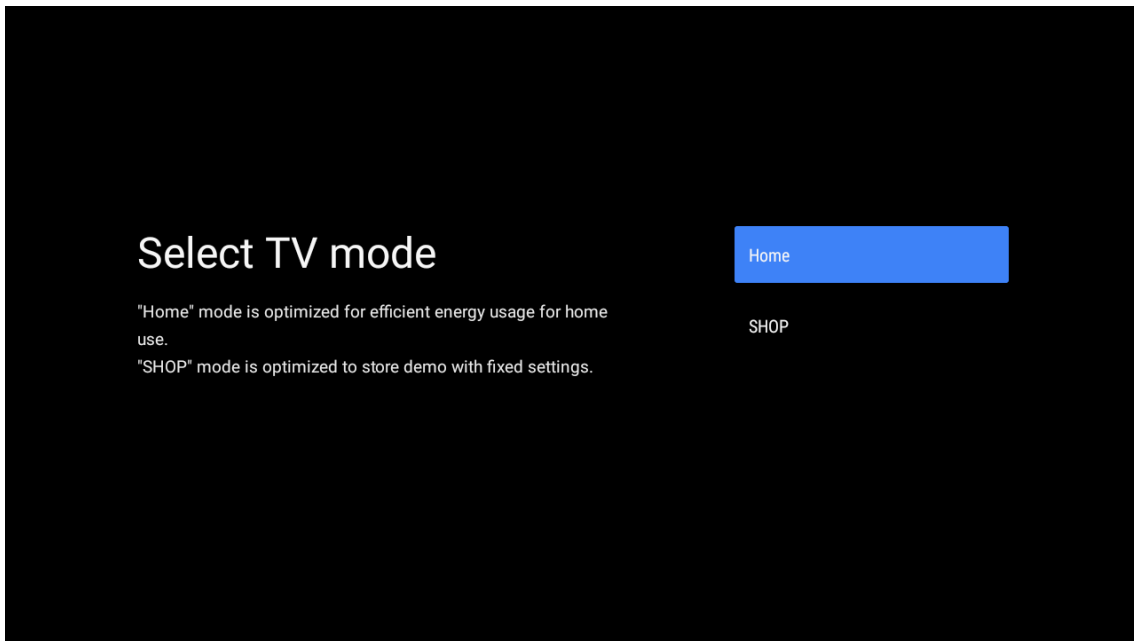

6.10. Chromecast built-in

Select On/Off to make Chromecast built-in available.

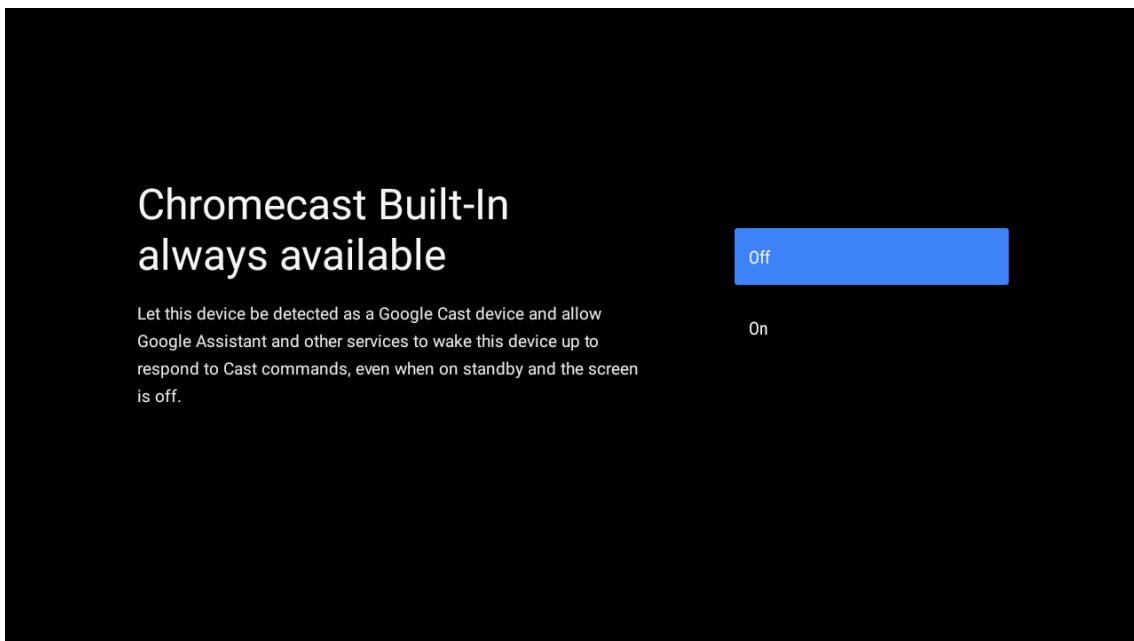

6.11. TV Channel Setting

Select Antenna/Cable/Satellite to scan TV channel.

If you select "Skip", the channel scan could be performed in menu.

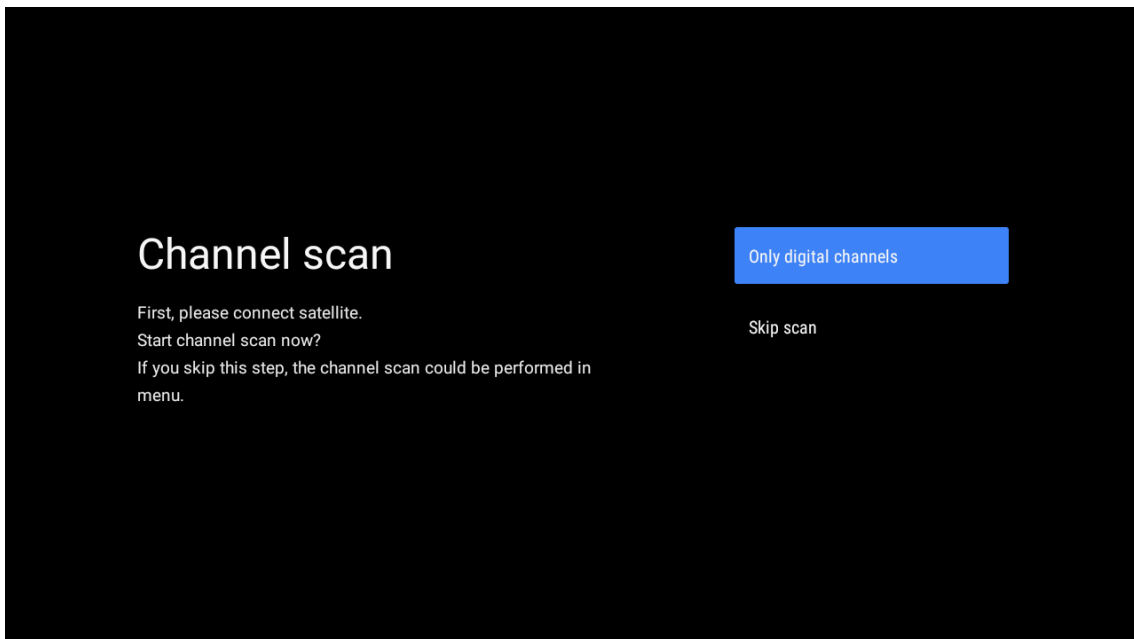
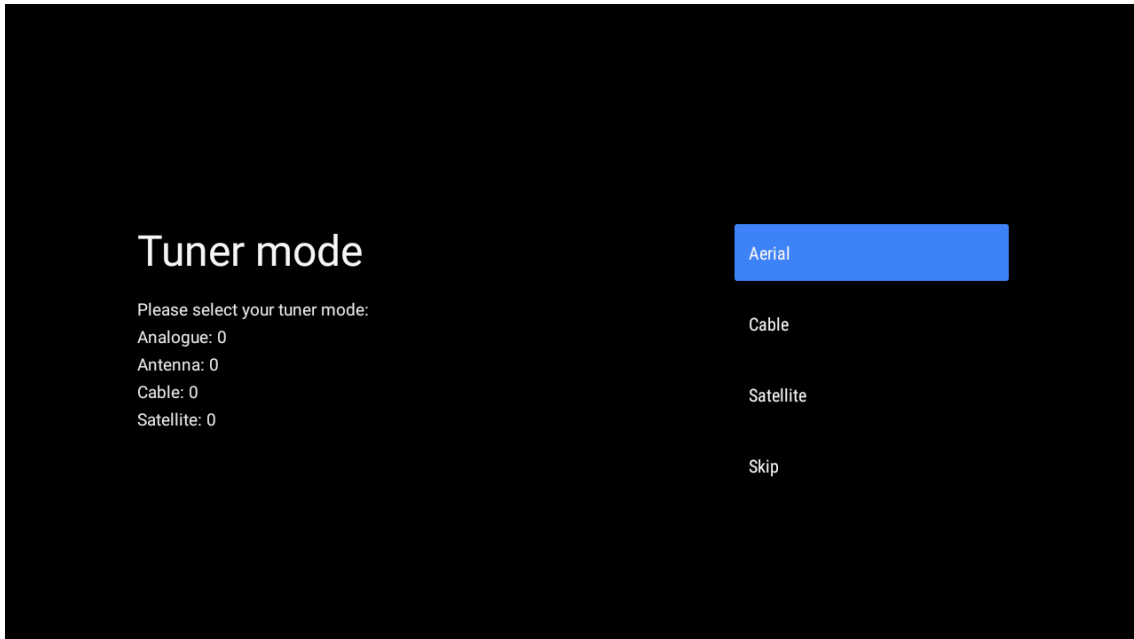

Setup completed and Disclaimer Terms

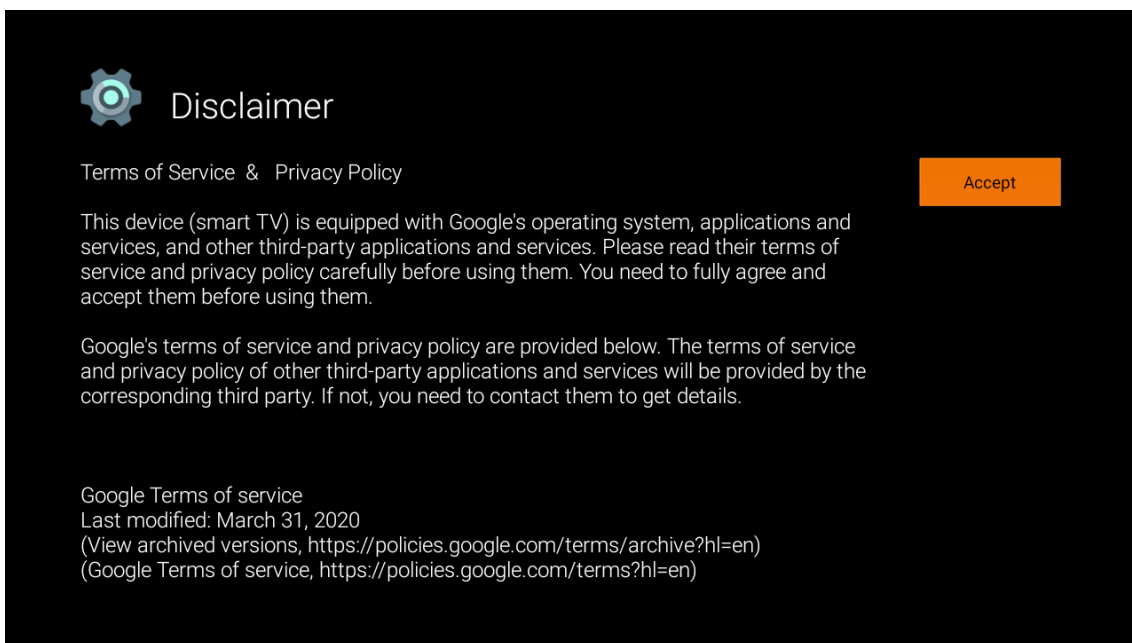
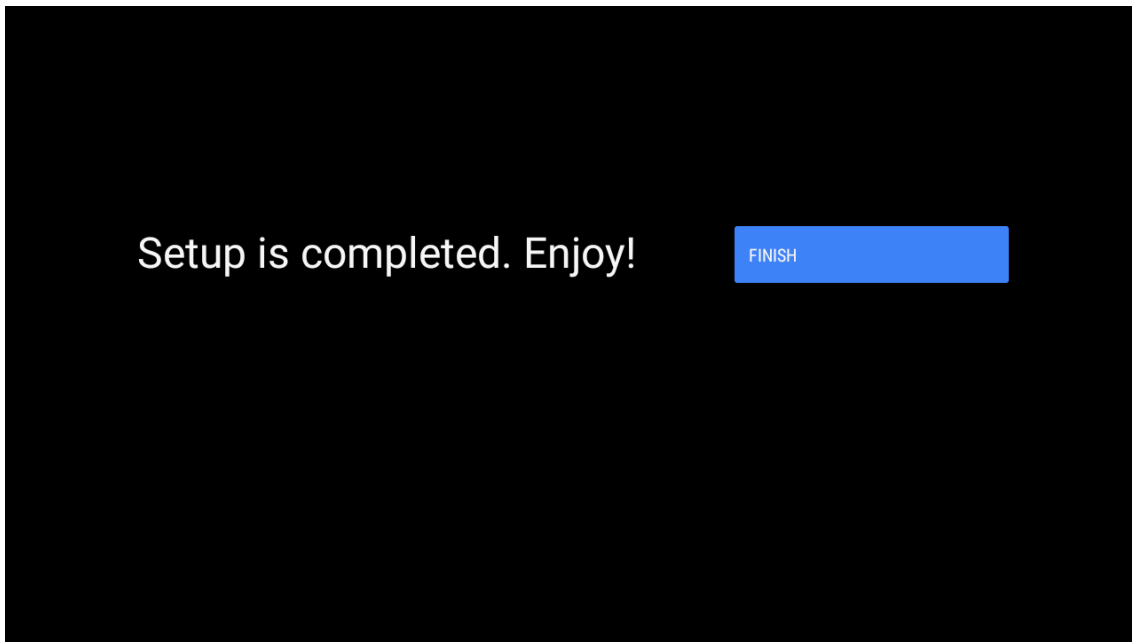

Note: If you don't want to perform a tuner scan, select one of the available options anyway. You can skip the scan at some later stage of the installation wizard. If you skip this step you can perform a channel search later using the related Channels menu options.

The next step is the selection of the tuner mode. Select your tuner preference to install channels for Live TV function. Antenna, Cable and Satellite options are available. Highlight the option that corresponds to your environment and press OK or Right directional button to proceed.

Antenna

If Antenna option is selected, the TV will search for digital terrestrial and analogue broadcasts. On the next screen highlight **Scan** option and press **OK** to start the search or select **Skip Scan** to continue without performing a search.

Cable

If Cable option is selected, the TV will search for digital cable and analogue broadcasts. If any, available operator options will be listed on the Select Operator screen. Otherwise, this step will be skipped. You can select only one operator from the list. Highlight the desired operator and press **OK** or the **Right** directional button to proceed.

On the next screen select **Scan** option to start a search or select **Skip Scan** to continue without performing a search. If **Scan** is selected a configuration screen will be displayed next. **Scan Mode, Frequency (kHz), Modulation, Symbol Rate (kSym/s), Network ID** options may need to be set. To perform a full scan set the **Scan Mode** as **Full/Advance** if available. Depending on the selected operator and/or Scan Mode some options may not be available to be set. Once you are done with setting available options, press the **Right** directional button to proceed. The TV will start to search available broadcasts.

Satellite

If Satellite option is selected, **Satellite Type** screen will be displayed next. Preferred **Satellite** and **General Satellite** options will be available. Select one and press **OK** to proceed.

Note: Preferred Satellite and General Satellite options may not be available depending on the selected country. In this case the DVBS Configuration Setting screen will be displayed after selecting the tuner mode as Satellite. If Preferred Satellite option is selected, next screen will be Select Operator screen. You can select only one operator from the list. Highlight the desired operator and press OK or the Right directional button to proceed. Some of the following options may be preset depending on the selected operator in this step. Check the parameters before proceeding and adjust if necessary.

For Austria and Germany **Load channel list** function, under search option **General Satellite**, is available.

DVB-S configuration

DVB-S Configuration Setting screen will be displayed next. First Antenna type should be set (This option may be named as Satellite type depending on the country selection.) Universal, Single Cable and Jess Single cable options are available. Set the Antenna Type as Universal for Direct and DiSEqC satellite systems. If you set the antenna type as Universal, press the Right directional button to proceed to the next step. If the antenna type is set as Single Cable or Jess Single cable, there will be three more additional options on the DVB-S Configuration Setting screen: Tuner, Band frequency and User Defined. User Defined option will be available if the Band frequency is set as User Defined. Set these options if available and press the Right directional button to proceed. Depending on the country and satellite type selections you made in the earlier steps of the initial setup process, Load Preset List screen may be displayed next. Highlight Load Preset List and press OK or the Right directional button to proceed with the SatcoDX installation. You can also skip this step by selecting Skip option. After the parameters on the DVB-S Configuration Setting screen are configured according to your environment and pre-set list installation preference is selected the next step may be Select Satellite screen. You may be able to set up different satellites depending on the selected antenna type and operator in the previous steps. Highlight the desired satellite option and press OK to set the parameters (If you have a Direct satellite system, DiSEqC Set option should be set as DiSEqC A.). The Satellite Status of the first satellite option will be set as On.

In order to configure other settings of the satellite and to enable scan this option should be set as On first. Press Back button and select the next satellite you want to set. After you completed the configuration changes, press the Right directional button to proceed.

If Load Preset List option is selected in the previous step next steps will be skipped and the preset channel list installation will start. If the correct satellite has not been selected for SatcoDX installation, a warning dialogue will be displayed on the screen. The satellite/s that can be selected will be listed. Press OK to close the dialogue and then set the satellite accordingly.

Channel Scan screen will be displayed next. Select Scan and press OK or the Right directional button to proceed with the scanning configurations. Select Skip Scan to proceed without performing a scan and complete the initial setup.

DVBS Scan Configure screen will be displayed next if Scan option is selected. Following options will be available: Scan Mode and Channels. You can choose to perform a full scan or a network scan. Set the Scan Mode accordingly. If you are going to perform a network scan, make sure that you have adjusted the Frequency, Symbol Rate (kSym/s) and Polarisation parameters under the Transponder option accurately on the Satellite Setup screen. You may not be able to change the Scan mode setting depending on the previous selections. If the Channels option is set as Free encrypted channels will not be installed. Additional options may also be available depending on the selected operator, configure these settings according to your preferences. Once you are done with setting the available options, press the Right directional button to start scan while Scan Mode or Channels is highlighted.

While the search continues you can press the Back button to cancel the search. The channels that have already been found will be stored in the channel list. When the initial setup is completed, results will be displayed. Press OK to finish the setup. Home Screen will be displayed. You can highlight Live TV app and press OK to switch to Live TV mode and watch.

7. Home

To enjoy the benefits of your Android TV, your TV must be connected to the Internet. Connect the TV to a home network with a high-speed Internet connection. You can connect your TV wirelessly or wired to your modem/router. Refer to the Network & Internet and Connecting to the Internet sections for further information on how to connect your TV to the internet.

The Home menu is the centre of your TV. Press the Home button to display the Home Screen. From the Home menu you can start any application, switch to a TV channel, watch a movie or switch to a connected device. Depending on your TV setup and your country selection in the initial setup the Home menu may contain different items.

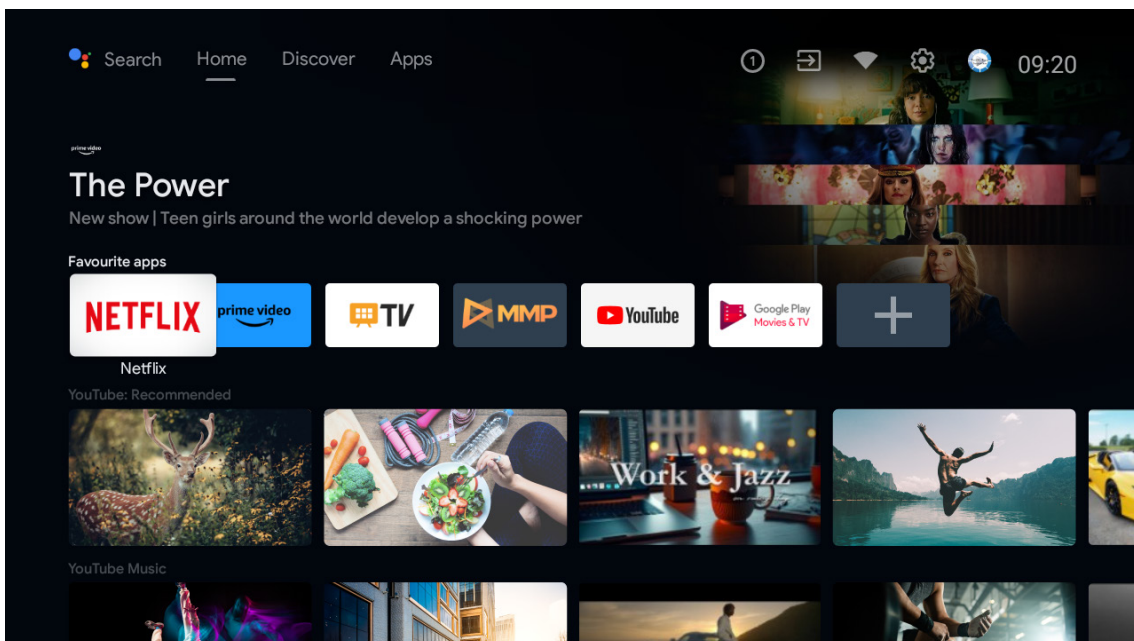
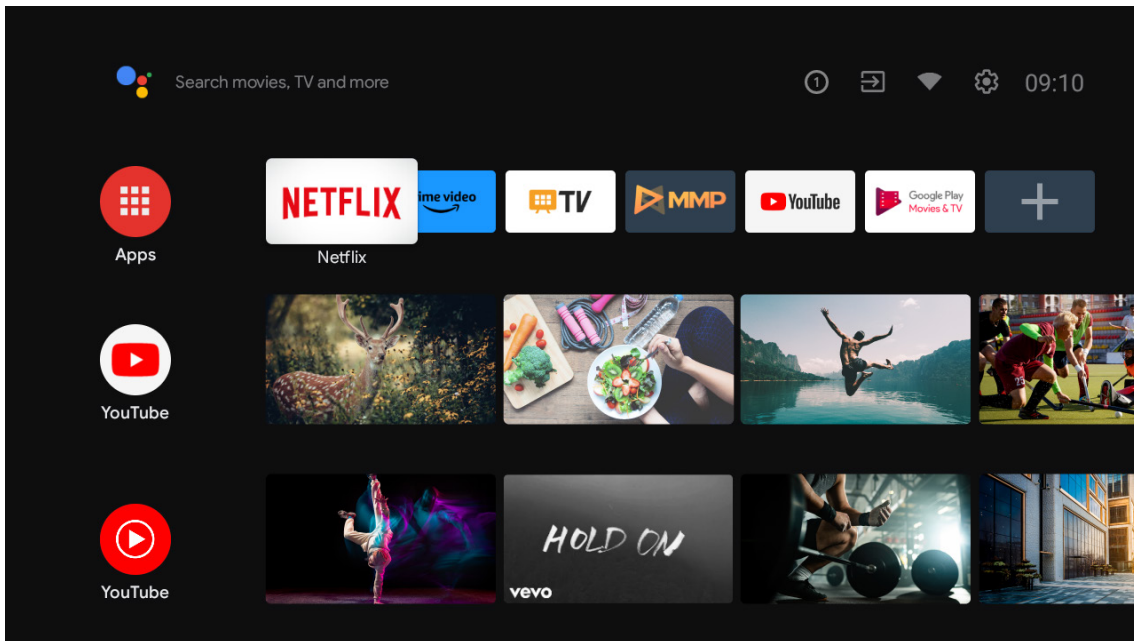

*Some countries home screen UI may display different as above image, please refer to your product for details.

The available options of the Home Screen are positioned in rows. To navigate through the Home Screen options, use the directional buttons on the remote. Apps, YouTube, Google Play Movies & TV, Google Play Music and Google Play related rows and rows of the applications you have installed might be available. Select a row then

move the focus to the desired item in the row. Press OK button to make a selection or to enter a sub-menu.

On the upper left of the screen, search tools will be located. You can choose either to type a word to start a search via the virtual keyboard or try voice search option if your remote has a built-in microphone. Move the focus to the desired option and press OK to proceed.

On the upper right of the screen, Notifications, Inputs, Network & Internet (will be named as Connected or Not Connected according to the current connection status), Settings and the current time will be displayed.

First row will be the Apps row. Live TV and Multimedia Player apps will be available alongside with other apps. Highlight Live TV and press OK to switch to Live TV mode. If the source was previously set to an option other than TV, press the Source button and select the TV to watch live TV channels.

8. Settings

Device Preferences

1. Press the directional buttons to select the options About, Date & Time, Timer, Language, Inputs, Picture, Sound, Google Assistant, Reset and others.
2. Press OK to jump to the corresponding sub-option.

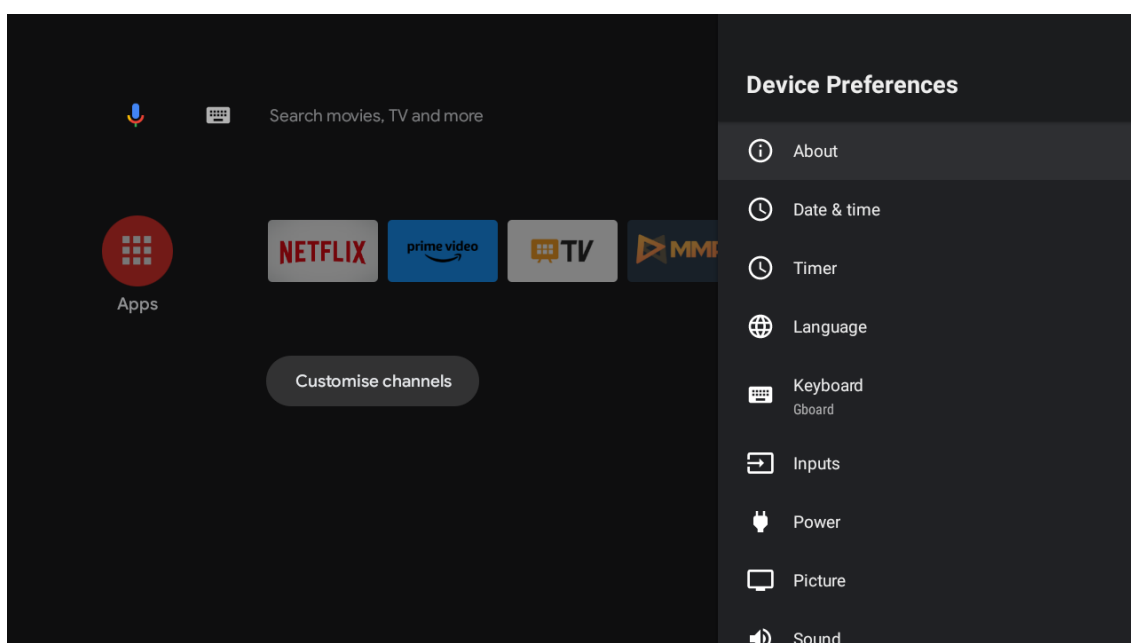

About

1. Press the directional buttons to check additional information such as system update, Device name, Restart, Status and more.
2. Press BACK button to return to previous menu
Press BACK again to exit the menu.

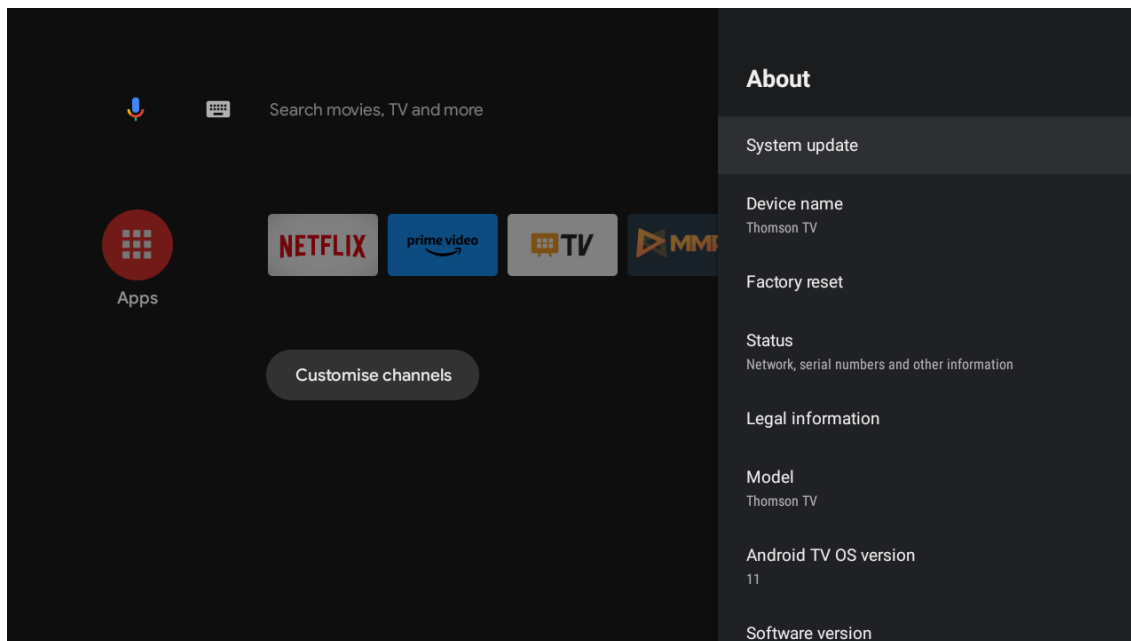

The above pictures are for reference only, please refer to the product for details.

Factory reset

If factory reset is selected, it will erase all data from your device's internal storage, including: your Google Account, system and app data and settings, and downloaded apps.

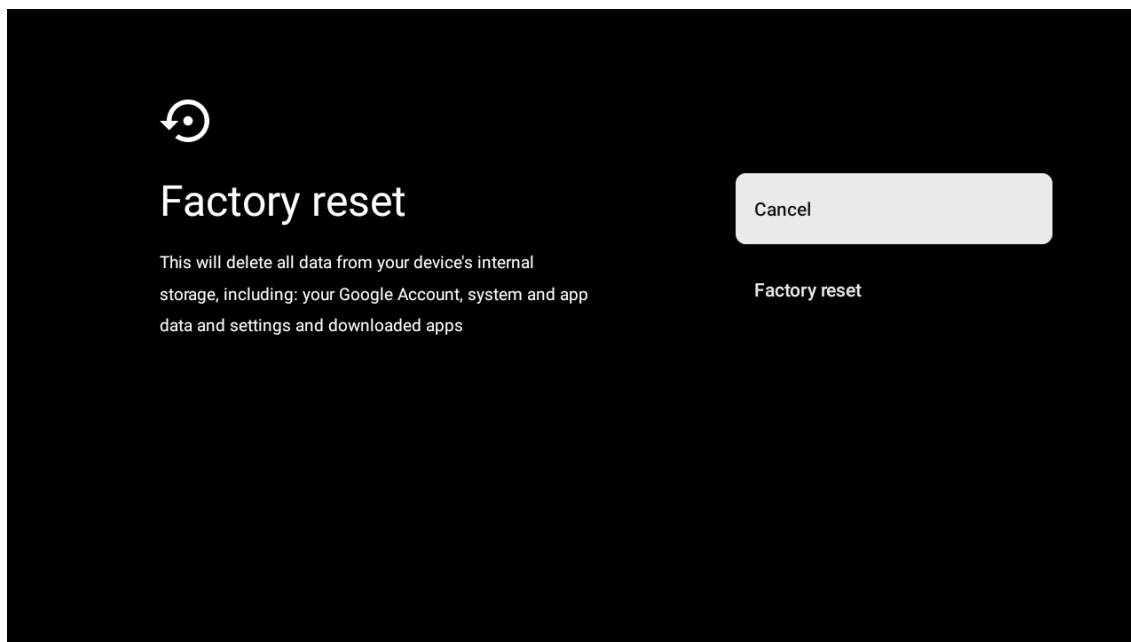

9. TV Source Settings

To enter TV source in Homepage:

Press the source button or Select "Live TV" on Homepage.

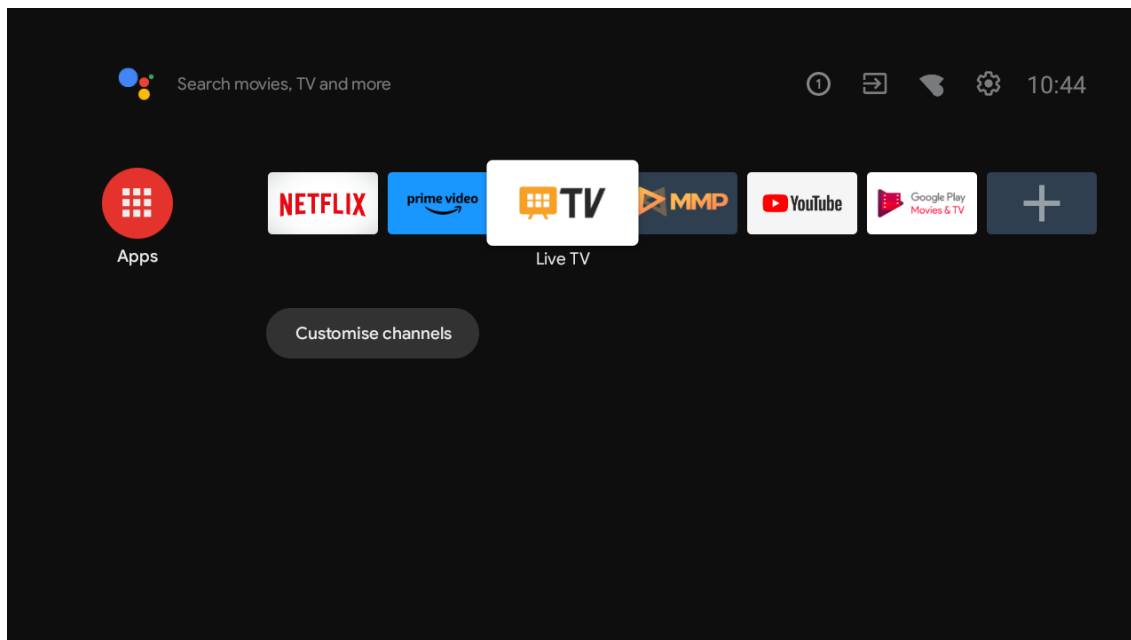

Press OK button, then select "Channels" and select "New Channels Available" to enter.

10. Channels management

To edit channel list, first make sure LCN function is disabled in channel settings menu. This can be done in the Channel menu along with other channel management options.

1. Open the LiveTV App.
2. Press round button on your remote and then press the RED DOT button (channel management).

Follow the following steps to edit the channels individually:

Channel SKIP

1. Open the LiveTV App.
2. Press round button on your remote and then press the red dot button (channel management).
3. Select Channel Skip option
4. Select the channels which you want to SKIP

Channel SWAP

1. Open the LiveTV App.
2. Press round button on your remote and then press the red dot button (channel management).
3. Select Channel Swap option
4. Select the channel which you want to SWAP (for example, channel 1).
5. Move the selection to the number where you want the channel to be swapped (for example, channel 16).
6. Confirm with round button

Channel MOVE

1. Open the LiveTV App.
2. Press round button on your remote and then press the red dot button (channel management).
3. Select Channel Move option
4. To change the channel position, select the channel that you want to MOVE (for example, channel 1).
5. Move the selection to the number where you want the channel to be moved to (for example, channel 5).

6. After selecting the position, press the Blue Dot button on your remote - a Warning message will appear.
7. Select YES and press OK on your remote. The channel will be moved to the desired position.

Channel EDIT

1. Open the LiveTV App.
2. Press round button on your remote and then press the red dot button (channel management).
3. Select Channel EDIT option
4. Select the channel that you want to EDIT (for example, channel 1).
5. Now you have option to edit the number of the channel and the channel name.

Channel DELETE

1. Open the LiveTV App.
2. Press round button on your remote and then press the red dot button (channel management).
3. Select Channel Delete option
4. Select the channel that you want to Delete (for example, channel 5).
5. After selecting the channel, press the Blue Dot button on your remote - a Warning message will appear.
6. Select YES and press OK on your remote. The channel will be deleted from the list.

11. Google Play

To have access and to download applications from the Google Play, you must sign in with a Google Account.

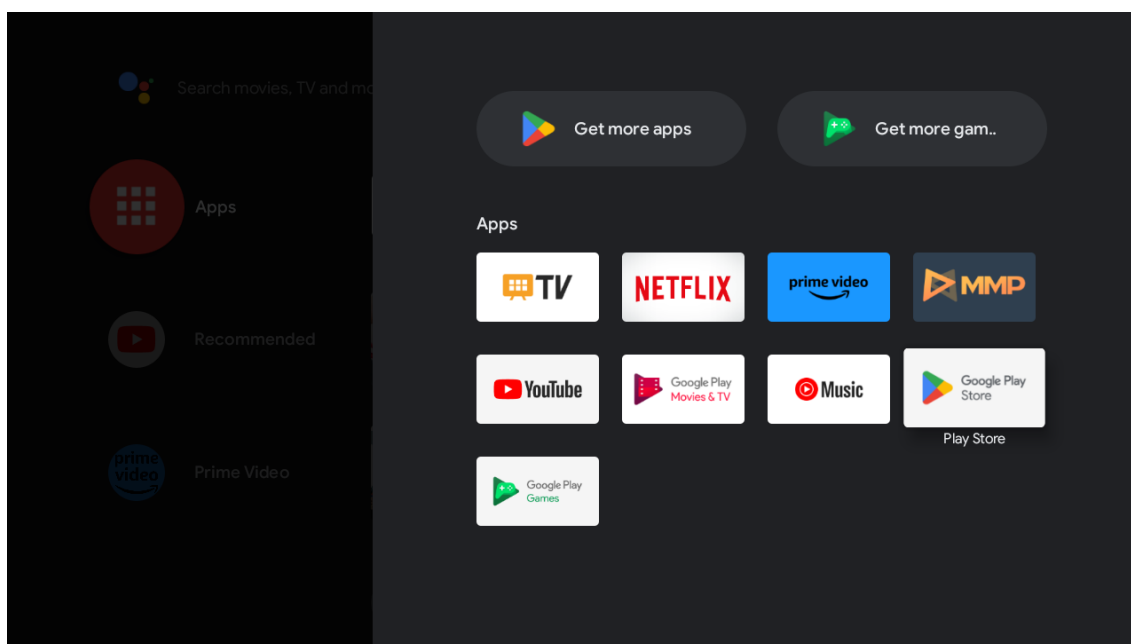

Once you open Google Play, you will be prompted to sign in or create a new account.

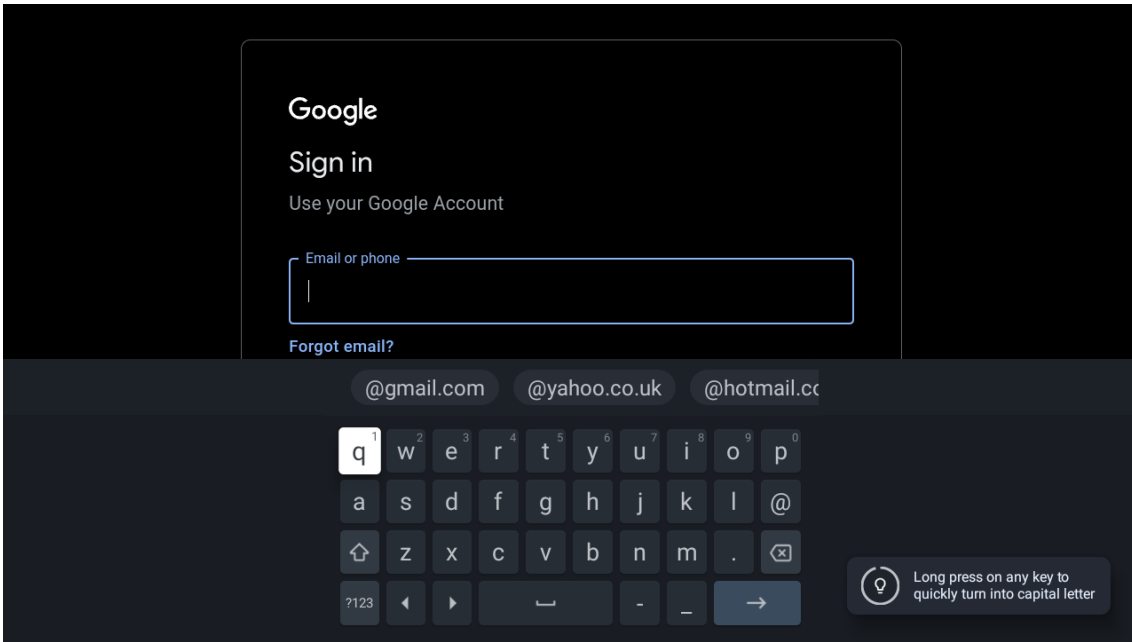

Once you have signed in, you will be brought to the below page, scroll through the list of applications available for download or press the Google Assistant button on your remote to talk to Google.

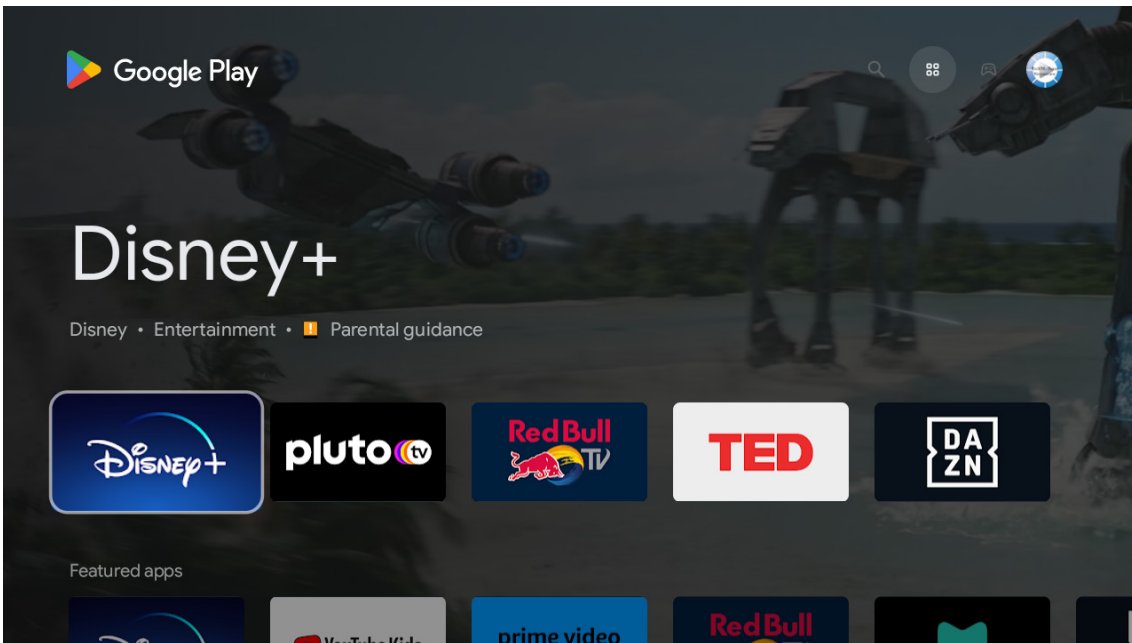

12. Troubleshooting

| | |
|--|---|
| No power | Check if the AC cord of TV is plugged in or not. If there's still no power, please disconnect the plug, and reconnect to the socket after 60 seconds. Turn the power back on. |
| Signal not received properly | Double or phantom images may appear on your TV if there are high buildings or mountains close to where you are. You can adjust the image through manual operation: consult instruction of vernier regulation, or adjust the direction of the external antenna. If you use an indoor antenna, signal reception may be more difficult under certain circumstances. Adjust the direction of the antenna for optimum reception. If this does not improve reception, you may have to switch to an external antenna. |
| No picture | Check if the antenna at the back is connected properly. View other channels to see if the problem still occurs. |
| Video appears with no audio | Try increasing the volume. Check if the TV's sound is on mute or not. |
| Audio is present, but video does not appear or is discolored | Try adjusting the contrast and brightness. |
| Static noise affects video and audio quality | Check if the antenna at the back is connected properly. |
| Broken lines on screen | Electrical appliances such as hair dryers or vacuums etc. may be interfering with your TV set. Switch these appliances off. |
| Remote doesn't work | Make sure the plastic bag which came with the remote control is removed. Try using the remote in a shorter distance from the TV. Check if the placement of the batteries is correct, or try using new batteries with the remote control. The TV will go into Standby mode if it receives no response in a few minutes. |
| Lines appearing when a device is connected to the RCA port | Make sure you are using a cable in good quality. |
| Problems are unresolved | Unplug the power cable and wait for 30 seconds, then reconnect to the socket. If problems still persist, do not attempt to repair the TV by yourself. Kindly contact the service center. |

13. Technical specifications

| | 24HA2S13 | 24HA2S13C/ 24HA2S13CW | 32HA2S13/ 32HA2S13W/ 32HA2S13C | 32FA2S13 | 40FA2S13/ 40FA2S13W | 43FA2S13 |
|---|------------------------|--------------------------------------|--------------------------------------|------------------------|------------------------|------------------------|
| Operating Voltage | 100-240 V, 50-60 Hz | 100-240 V, 50-60 Hz | 100-240 V, 50-60 Hz | 100-240 V, 50-60 Hz | 100-240 V, 50-60 Hz | 100-240 V, 50-60 Hz |
| AC Adaptor Specifications (Output) | | 12 V $\overline{\text{=}}$ 3 A, 36 W | 12 V $\overline{\text{=}}$ 3 A, 36 W | | | |
| Audio (DTS HD) | no | no | no | no | no | no |
| Audio Output Power | 2 x 3 | 2 x 3 | 2 x 8 | 2 x 8 | 2 x 8 | 2 x 8 |
| Power Consumption (W) | 36 | 36 | 56 | 56 | 90 | 90 |
| Networked Standby Power Consumption (W) | < 0,5 | < 0,5 | < 0,5 | < 0,5 | < 0,5 | < 0,5 |
| Weight (Kg) | 2.25 | 2.25 | 3.35 | 3.35 | 5.35 | 6 |
| TV Dimensions DxLxH (with foot) (mm) | 535 x 151 x 353 | 535 x 151 x 353 | 719 x 151 x 456 | 719 x 151 x 456 | 892 x 172 x 559 | 955 x 172 x 590 |
| TV Dimensions DxLxH (without foot) (mm) | 535 x 75 x 318 | 535 x 75 x 318 | 719 x 82 x 423 | 719 x 82 x 423 | 892 x 84 x 509 | 955 x 85 x 555 |
| Display | 24"/60 cm | 24"/60 cm | 32"/80 cm | 32"/80 cm | 40"/101 cm | 43"/109 cm |

| | 43UA5S13 | 50UA5S13 | 55UA5S13 | 65UA5S13 | 75UA5S13 |
|---|------------------------|------------------------|------------------------|------------------------|------------------------|
| Operating Voltage | 100-240 V, 50-60 Hz | 100-240 V, 50-60 Hz | 100-240 V, 50-60 Hz | 100-240 V, 50-60 Hz | 100-240 V, 50-60 Hz |
| AC Adaptor Specifications (Output) | | | | | |
| Audio (DTS HD) | no | no | no | no | no |
| Audio Output Power | 2 x 8 | 2 x 10 | 2 x 10 | 2 x 12 | 2 x 12 |
| Power Consumption (W) | 90 | 100 | 110 | 160 | 220 |
| Networked Standby Power Consumption (W) | < 0,5 | < 0,5 | < 0,5 | < 0,5 | < 0,5 |
| Weight (Kg) | 6.3 | 8.5 | 11.5 | 16.7 | 24 |
| TV Dimensions DxLxH (with foot) (mm) | 957x172x592 | 1111x260x692 | 1229x260x747 | 1446x293x867 | 1667x300x1023 |
| TV Dimensions DxLxH (without foot) (mm) | 957x85x556 | 1111x75x643 | 1229x77x710 | 1446x78x831 | 1667x85x955 |
| Display | 43"/109 cm | 50"/126 cm | 55"/139 cm | 65"/164 cm | 75"/189 cm |

| | 43QA2S13 | 50QA2S13 | 55QA2S13 | 65QA2S13 | 75QA2S13 |
|---|------------------------|------------------------|------------------------|------------------------|------------------------|
| Operating Voltage | 100-240 V, 50-60 Hz | 100-240 V, 50-60 Hz | 100-240 V, 50-60 Hz | 100-240 V, 50-60 Hz | 100-240 V, 50-60 Hz |
| AC Adaptor Specifications (Output) | | | | | |
| Audio (DTS HD) | no | no | no | no | no |
| Audio Output Power | 2 x 8 | 2 x 10 | 2 x 10 | 2 x 10 | 2 x 10 |
| Power Consumption (W) | 90 | 100 | 110 | 160 | 220 |
| Networked Standby Power Consumption (W) | < 0,5 | < 0,5 | < 0,5 | < 0,5 | < 0,5 |
| Weight (Kg) | 6.3 | 8.5 | 11.5 | 16.7 | 24 |
| TV Dimensions DxLxH (with foot) (mm) | 957x172x592 | 1111x260x692 | 1229x260x747 | 1446x293x867 | 1667x300x1023 |
| TV Dimensions DxLxH (without foot) (mm) | 957x85x556 | 1111x75x643 | 1229x77x710 | 1446x78x831 | 1667x85x955 |
| Display | 43"/109 cm | 50"/126 cm | 55"/139 cm | 65"/164 cm | 75"/189 cm |

13.1. Country restrictions

Intended for indoor use only in EU member states and EFTA states.

**AT BE BG CH CY CZ DE DK EE ES FI FR GR HR HU IE IS
IT LI LT LU LV MT NL NO PL PT RO SI SK SE TR UK (NI)**

13.2. Licences

Subject to alterations. In consequence of continuous research and development technical specifications, design and appearance of products may change.

Google, Google Play, Android TV, Chromecast built-in and other marks are trademarks of Google LLC. Google Assistant is not available in certain languages and countries. Availability of services varies by country and language. Netflix is a registered trademark of Netflix, Inc. Netflix streaming membership required. 4K Ultra HD availability subject to your subscription plan, Internet service, device capabilities, and content availability. www.netflix.com/TermsOfUse (La disponibilité de la 4K Ultra HD dépend de votre forfait Netflix, de votre connexion Internet, des capacités de l'appareil et de la disponibilité du contenu. www.netflix.com/TermsOfUse). Apple TV is a trademark of Apple Inc., registered in the U.S. and other countries and regions.

Wi-Fi is a registered trademark of Wi-Fi Alliance®. The terms HDMI and HDMI High-Definition Multimedia Interface, and the HDMI logo are trademarks or registered marks of HDMI Licensing Administrator, Inc. in the United States and other countries.

Dolby, Dolby Vision, Dolby Atmos, Dolby Audio, and the double-D symbol are trademarks of Dolby Laboratories Licensing Corporation. Manufactured under license from Dolby Laboratories. Confidential unpublished works. Copyright © 1992–2022 Dolby Laboratories. All rights reserved.

All product names are trademarks or registered trademarks of their respective owners.

© THOMSON, and the THOMSON logo are trademarks used under license by StreamView GmbH, Franz-Josefs-Kai 1, 1010 Vienna, Austria – further information at www.thomson-brand.com.