

# ***THOMSON***

---



[tv.mythomson.com](https://tv.mythomson.com)



[tv.mythomson.com/  
en/Support/FAQs/](https://tv.mythomson.com/en/Support/FAQs/)

# SMART TV

## IMPORTANT

Please read this manual carefully before installing and operating the TV.

Keep this manual handy for further reference.

### Contents

1	Safety Information .....	6
1.1	Markings on the product.....	7
1.2	Warning.....	7
1.3	Wall mounting warnings.....	8
1.4	Simplified EU declaration of conformity.....	8
1.5	Apps and performance.....	8
1.6	Data protection .....	9
2	Introduction and feet/stand installation.....	9
2.1	Unpacking .....	9
2.2	Installation.....	11
3	TV buttons and connections.....	12
3.1	TV button.....	12
3.2	Connections.....	13
4	Remote Control.....	14
5	TV installation .....	15
5.1	Set your TV.....	15
5.2	Connect antenna and power.....	15
6	Initial setup .....	16
6.1	Pairing Bluetooth remote.....	16
6.2	Language selection.....	16
6.3	TV setup selection.....	17
6.4	Set up Google TV.....	18
6.4.1	Set up with the Google Home App .....	18
6.4.2	Set up on TV.....	18
6.4.3	Sign-in with your Google account .....	19
6.4.4	Google Terms of Services .....	19
6.4.5	Confirm or reject Google services and features.....	20

6.4.6	Choose your subscriptions.....	20
6.4.7	Region or country selection.....	21
6.4.8	Disclaimer.....	22
6.5	Set up basic TV.....	22
6.5.1	Select your Wi-Fi network.....	22
6.5.2	Region or country selection.....	22
6.5.3	Disclaimer.....	23
6.6	Parental Control.....	23
7	Channel installation.....	24
7.1	Tuner mode.....	25
7.1.1	Antenna.....	25
7.1.2	Cable.....	26
7.1.3	Satellite.....	27
8	Check settings.....	33
9	Home screen.....	34
9.1	Google account.....	35
9.2	Apps.....	36
9.3	Library.....	37
9.4	Google TV search.....	37
9.5	Notification.....	38
10	Settings.....	39
10.1	Set your device name.....	39
10.2	Channels and inputs.....	40
10.2.1	Channels.....	40
10.2.2	External Inputs.....	53
10.3	Display and Sound.....	55
10.3.1	Picture.....	55
10.3.2	Screen.....	56
10.3.3	Sound.....	56
10.3.4	Audio Output.....	56
10.4	Network and Internet.....	57
10.4.1	Wi-Fi On/Off.....	57

10.4.2	Choose available Wi-Fi network.....	57
10.4.3	Other options.....	58
10.4.4	Ethernet options.....	58
10.5	Accounts and sign-in .....	58
10.6	Privacy.....	59
10.7	Apps.....	60
10.8	System.....	60
10.8.1	Accessibility.....	61
10.8.2	About.....	61
10.8.3	Date and Time.....	62
10.8.4	Language .....	62
10.8.5	Keyboard.....	62
10.8.6	Storage .....	62
10.8.7	Ambient Mode.....	62
10.8.8	Power and Energy.....	62
10.8.9	Cast .....	63
10.8.10	Google .....	63
10.8.11	System sounds.....	63
10.8.12	Television.....	63
10.8.13	System running time .....	64
10.8.14	Restart.....	64
10.9	Remote and Accessories .....	64
10.10	Help and feedback.....	65
11	Live TV.....	65
11.1	Channels Menu.....	66
11.1.1	Program Guide .....	66
11.1.2	New Channels available .....	67
11.2	TV Options .....	68
11.2.1	Subtitle Language.....	68
11.2.2	Add Favorite .....	69
11.2.3	Remove Favorite.....	72
11.2.4	Open Favorites.....	73

11.2.5	Audio Language.....	74
11.2.6	Channel Options.....	74
12	Multimedia Player App.....	78
13	Troubleshooting.....	79
14	Technical specifications.....	80
14.1	Country restrictions.....	83
14.2	Licenses.....	83

# 1 Safety Information



In extreme weather (storms, lightning) and long inactivity periods (going on holiday) disconnect the TV set from the mains.

The mains plug is used to disconnect the TV set from the mains and therefore it must remain readily operable. If the TV set is not disconnected electrically from the mains, the device will still draw power for all situations even if the TV is in standby mode or switched off.

**Note:** Follow the onscreen instructions for operating the related features.

**Important:** Please read these instructions fully before installing or operating the TV.

## WARNING

**This device is intended to be used by persons (including children) who are capable / experienced of using such a device unsupervised, unless they have been given supervision or instruction concerning the use of the device by a person responsible for their safety.**

- Use this TV set at an altitude of less than 2000 meters above sea level, in dry locations and in regions with moderate or tropical climates.
- The TV set is intended for household and similar general use but may also be used in public places.
- For ventilation purposes, leave at least 10cm of free space around the TV.
- The ventilation should not be impeded by covering or blocking the ventilation openings with items, such as newspapers, tablecloths, curtains, etc.
- The power cord plug should be easily accessible. Do not place the TV, furniture, etc. on the power cord. A damaged power cord/plug can cause fire or give you an electric shock. Handle the power cord by the plug, do not unplug the TV by pulling the power cord. Never touch the power cord/plug with wet hands as this could cause a short circuit or electric shock. Never make a knot in the power cord or tie it with other cords. When damaged it must be replaced, this should only be done by qualified personnel.
- Do not expose the TV to dripping or splashing of liquids and do not place objects filled with liquids, such as vases, cups, etc. on or over the TV (e.g., on shelves above the unit).
- Do not expose the TV to direct sunlight and do not place open flames such as lit candles on the top of or near the TV.
- Do not place any heat sources such as electric heaters, radiators, etc. near the TV set.
- Do not place the TV on the floor or inclined surfaces.
- To avoid danger of suffocation, keep plastic bags out of reach of babies, children and domestic animals.
- Carefully attach the stand to the TV. If the stand is provided with screws, tighten the screws firmly to prevent the TV from tilting. Do not over-tighten the screws and mount the stand rubbers properly.
- Do not dispose of the batteries in fire or with hazardous or flammable materials.

## WARNING

- Batteries must not be exposed to excessive heat such as sunshine, fire or the like.
- Excessive sound pressure from earphones or headphones can cause hearing loss.

**ABOVE ALL - NEVER let anyone, especially children, push or hit the screen, push anything into holes, slots or any other openings in the case.**

## 1.1 Markings on the product

The following symbols are used on the product as a marker for restrictions and precautions and safety instructions. Each explanation shall be considered where the product bears related marking only. Note such information for security reasons.



Class II Equipment: This appliance is designed in such a way that it does not require a safety connection to electrical earthing.



This marking indicates that this product should not be disposed with other household wastes throughout the EU. Please recycle it responsibly to promote the sustainable reuse of material resources. To return your used device, please use the return and collection systems or contact the retailer where the product was purchased.

## 1.2 Warning

Do not ingest the battery, due to Chemical Burn Hazard. This product or the accessories supplied with the product may contain a coin/button cell battery. If the coin/button cell battery is swallowed, it can cause severe internal burns in just 2 hours and can lead to death.

Keep new and used batteries away from children. If the battery compartment does not close securely, stop using the product and keep it away from children.

If you think batteries might have been swallowed or placed inside any part of the body, seek immediate medical attention.

A television may fall, causing serious personal injury or death. Many injuries, particularly to children, can be avoided by taking simple precautions such as:

- ALWAYS use cabinets or stands or mounting methods recommended by the manufacturer of the television set.
- ALWAYS use furniture that can safely support the television set.
- ALWAYS ensure the television set is not overhanging the edge of the supporting furniture.
- ALWAYS educate children about the dangers of climbing on furniture to reach the television set or its controls.
- ALWAYS route cords and cables connected to your television so they cannot be tripped over, pulled or grabbed.
- NEVER place a television set in an unstable location.

- NEVER place the television set on tall furniture (for example, cupboards or bookcases) without anchoring both the furniture and the television set to a suitable support.
- NEVER place the television set on cloth or other materials that may be located between the television set and supporting furniture.
- NEVER place items that might tempt children to climb, such as toys and remote controls, on top of the television or furniture on which the television is placed on.
- The equipment is only suitable for mounting at heights  $\leq 2$  m.

If the existing television set is going to be retained and relocated, the same considerations as above should be applied.

Apparatus connected to the protective earthing of the building installation through the mains connection or through other apparatus with a connection to protective earthing – and to a television distribution system using coaxial cable, may in some circumstances create a fire hazard. Connection to a television distribution system has therefore to be provided through a device providing electrical isolation below a certain frequency range (galvanic isolator).

### **1.3 Wall mounting warnings**

- Read the instructions before mounting your TV on the wall.
- The wall mount kit is optional. You can obtain it from your local dealer if it is not supplied with your TV.
- Do not install the TV on the ceiling or on an inclined wall.
- Use the specified wall mounting screws and other accessories.

Tighten the wall mounting screws firmly to prevent the TV from falling. Do not overtighten the screws.

Figures and illustrations in this user manual are provided for reference only and may differ from the actual product appearance. Product design and specifications may be changed without notice.

### **1.4 Simplified EU declaration of conformity**

Hereby, StreamView GmbH declares that the radio equipment type product device Smart TV is complying with Directive 2014/53/EU.

### **1.5 Apps and performance**

Download speed depends on your Internet connection. Some apps might not be available in your country or region. Netflix is available in selected countries:

<https://help.netflix.com/node/14164> Streaming membership is required. More information at [www.netflix.com](http://www.netflix.com). The availability of the language for Google Assistant depends on Google Voice Search support.



## 1.6 Data protection

The application providers and the providers of the services may collect and use technical data and related information, including but not limited to technical information about this device, system and application software and peripherals. They may use such information to improve products or to provide services or technologies which do not personally identify you.

Additionally, some third-party services, already provided in the device or installed by you after purchasing the product, may request a registration with your personal data. Some services may collect personal data without providing additional warnings. StreamView GmbH cannot be held liable for a possible breach of data protection by third-party services.

## 2 Introduction and feet/stand installation

Thank you for choosing our product. You'll soon be enjoying your new TV. Please read these instructions carefully. They contain important information which will help you get the best from your TV and ensure safe and correct installation and operation.

### 2.1 Unpacking

Take out the feet/stand and the TV from the packing and put the feet onto a table or any other even surface.

- Use a flat and firm table or similar even surface that can support the weight of the TV.
- Do not hold the TV on the screen panel.
- Make sure not to scratch or break the TV.
- The feet are marked left and right.

#### Models with Central Swivel Stand

**1** 43" - 55"

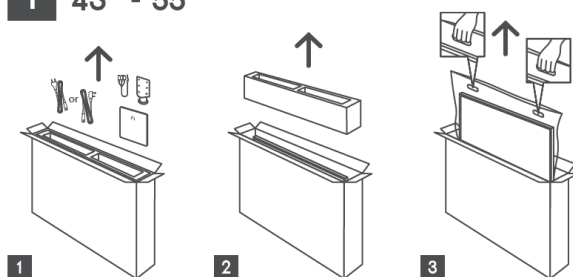

**1** 65" - 75" 

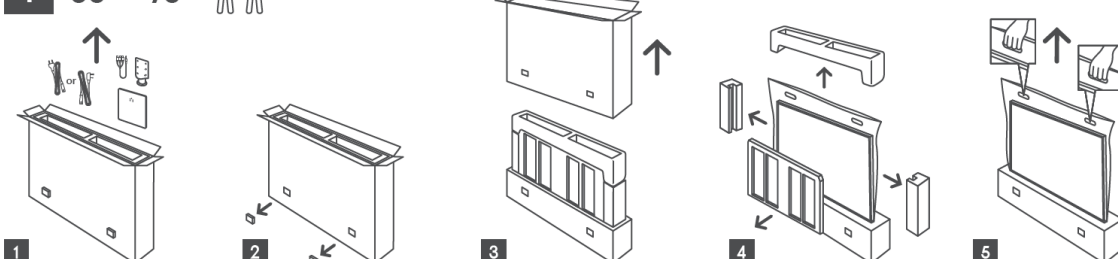

## Models with Side Feet

**1** 43" - 55"

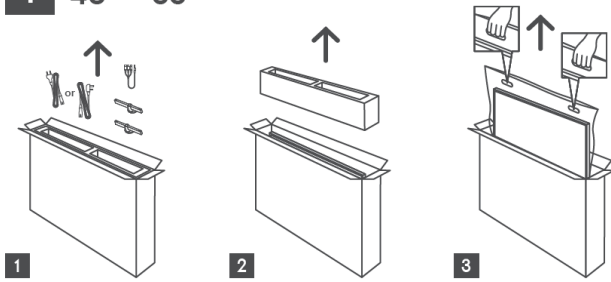

**1** 65"-85" 

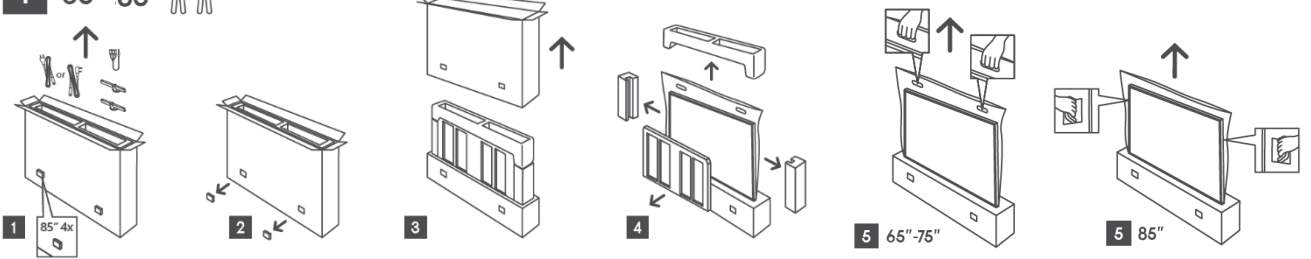

**1** 100" 

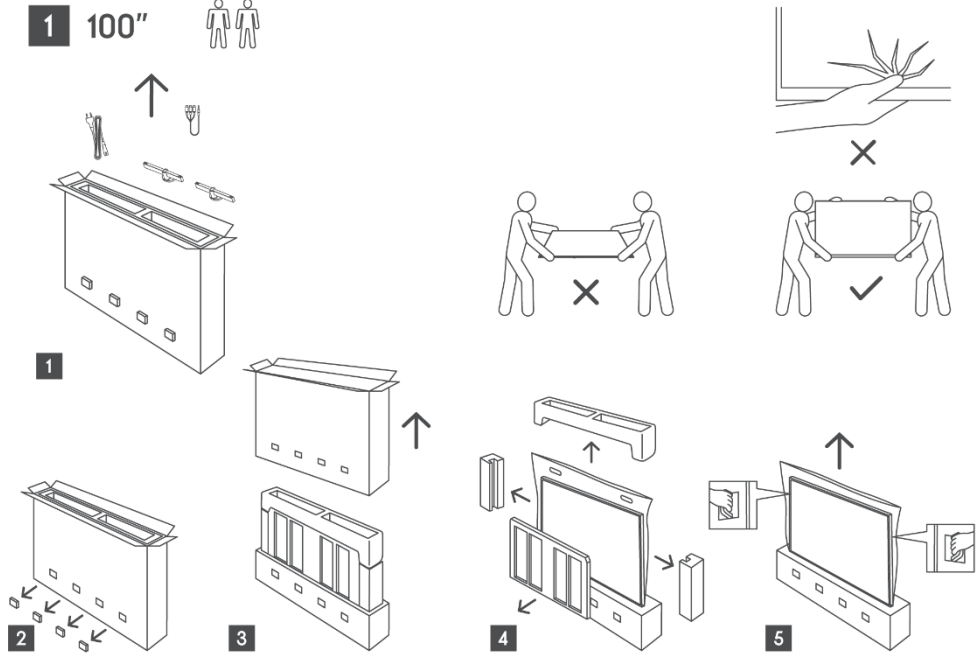

## 2.2 Installation

All images are for reference only. Please refer to the product itself and the QIG, which is inside the box, for more details.

### Models with Central Swivel Stand

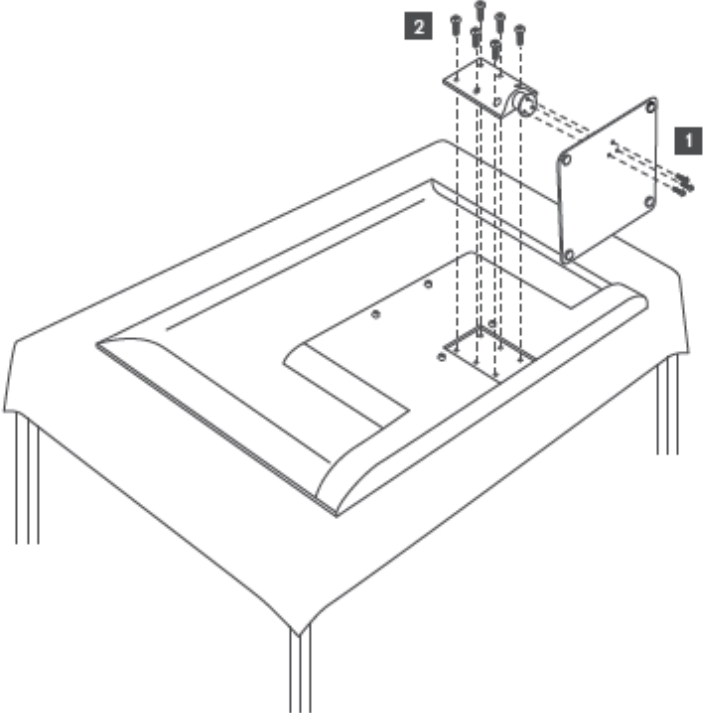

### Models with Side Feet

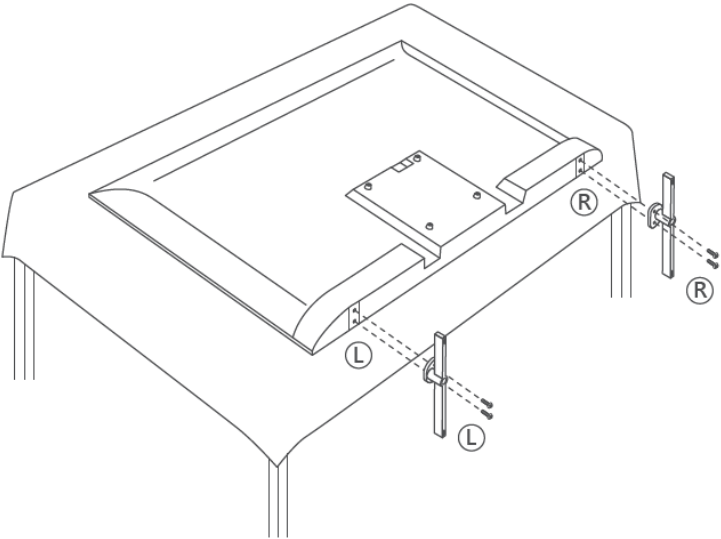

Your TV is prepared for a VESA-compliant wall mount bracket. This is not supplied with your TV. Contact your local dealer to purchase the recommended wall mount bracket.

Holes and measurements for wall mount bracket installation:

	W (mm)	H (mm)	D (mm)	L (mm)
43"	200	200	6 (M6)	8
50"	200	200	6 (M6)	8
55"	200	200	6 (M6)	10
65"	200	200	6 (M6)	10
75"	200	200	6 (M6)	10
85"	200	200	6 (M6)	10
100"	800	400	8(M6)	12

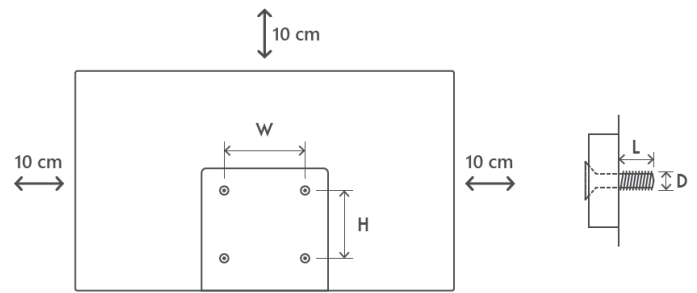

### 3 TV buttons and connections

**Caution:**



If you want to connect a device to the TV, make sure that both the TV and the device are turned off before making any connection. After the connection is done, you can turn on the units and use them.



Do not touch or be close to the HDMI, USB terminals, and prevent electrostatic discharge from disturbing these terminals while in USB operation mode, or it will cause the TV to stop working or cause an abnormal status.

**Note:**

The actual position and arrangement of ports may be different from model to model.

#### 3.1 TV button

The exact appearance of the TV, including logo placement and frame, differs by TV model. Please use these illustrations as reference only.

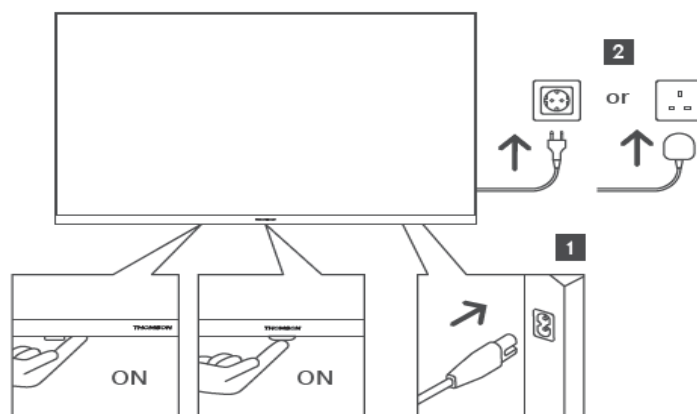





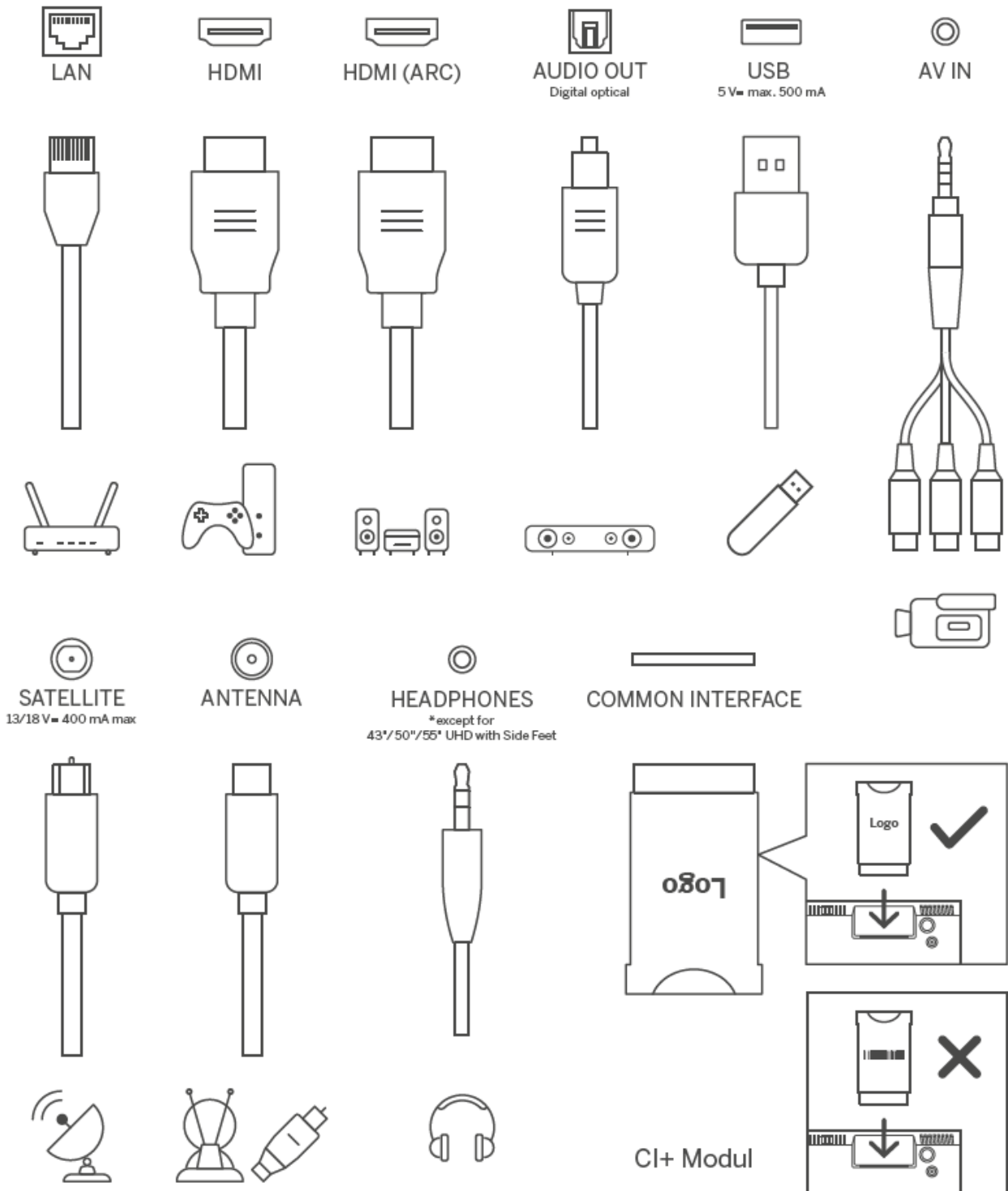



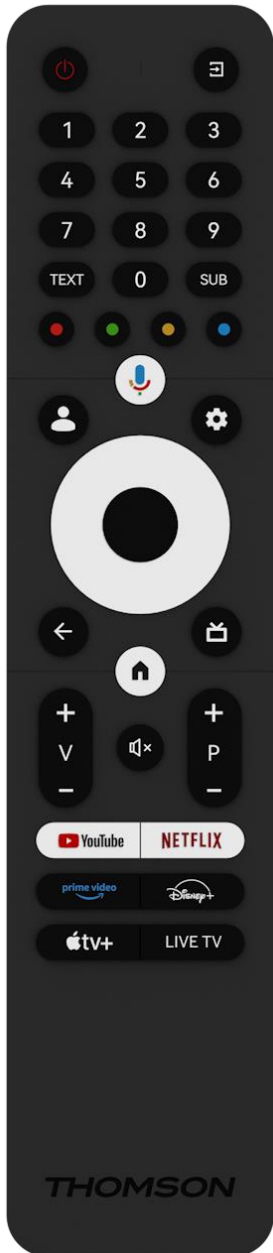









Press this button in standby mode to turn on / off the TV.

## 3.2 Connections



## 4 Remote Control



	Power button/Standby: Quick Standby / Standby / On
	Source/Input: Select the input of the TV
0-9	Numeric buttons: Switch the channel in Live TV mode, enter a number or a letter in the text box on the screen
TEXT	Open and close teletext (where available in Live TV mode)
SUB	Turn subtitles on and off (where available)
	Colored Buttons: Follow the on-screen instructions for colored button functions
	Microphone: Activate the Google Assistant
	Profile Switch: Switch between multiple Google profiles
	Settings: Display Live TV Settings menu (in Live TV mode), display available setting options such as sound and picture; an additional keyboard with more functions opens in the TV Live app.
	Directional buttons: Navigate menus, setting options, move the focus or cursor etc., and display the subpages in Live TV-Teletext mode when pressed Right or Left. Follow the on-screen instructions
	OK: Confirm selections, enter sub-menus, view channel list (in Live TV mode). Press 5 sec. to switch the backlight of the remote control on/off
	Back/Return: Return to previous menu screen, go one step back, close windows, close teletext (in Live TV-Teletext mode). Exit the playback of multimedia files and return to the MMP (Multi Medi Player) overview menu
	Electronic program guide
	Home: Open the Home Screen
+ v -	Volume +/-: Control the Sound Volume of the TV.
	Mute: Completely turn off the volume of the TV
+ P -	Programs +/-: Switch between TV/radio channels. Scroll the channel list page by page when the channel list is displayed on the TV screen.
	Launch the YouTube application
	Launch the Netflix application
	Launch the Prime Video application
	Launch the Disney + application
	Launch the Apple TV application
LIVE TV	Launch the Live TV application

## 5 TV installation

### 5.1 Set your TV

Put your TV on a firm place which can handle the weight of the TV. To avoid danger, please do not position the TV near water or heat sources (such as light, candle, heater), do not block the ventilation at the back of the TV.

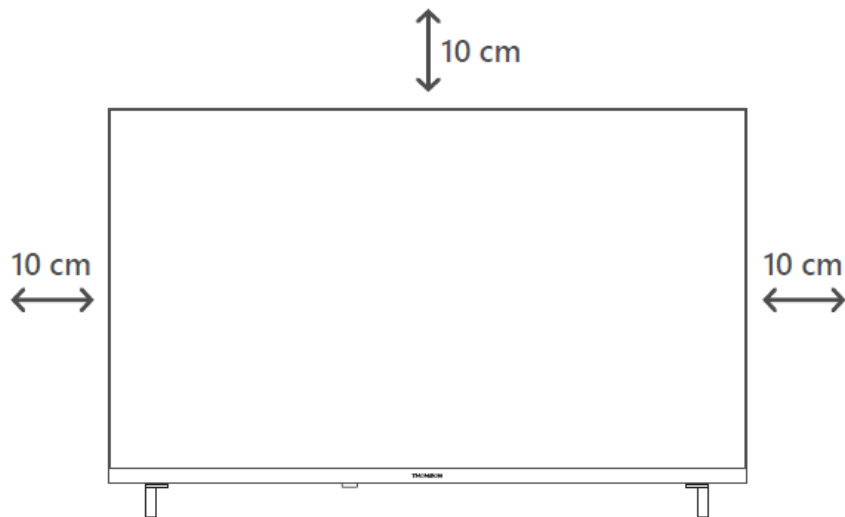

### 5.2 Connect antenna and power

1. Connect the antenna cable to the antenna socket on the back of the TV.
2. Plug in the power cord of your TV (AC 100-240 V~ 50/60 Hz). The TV enters standby mode (red light).
3. Turn on your TV by pressing the power button of the TV or the power button on the remote control.

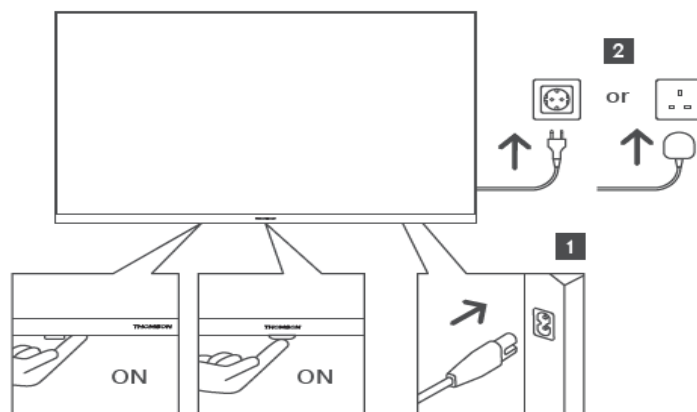

*\*The exact appearance of the TV, including logo placement and frame, differs by TV model. Please use these illustrations as reference only.*

## 6 Initial setup

For the first initial setup, the on-screen setup wizard will guide you through setting up your TV. Please follow the instructions carefully to setup your TV correctly.

### 6.1 Pairing Bluetooth remote

Press the **BACK** and **Home** buttons simultaneously on your remote control to enter the Bluetooth pairing mode. The indicator light on the remote control will flash when starting the pairing process.

We recommend that you complete the remote control pairing process. However, if you skip this, you can subsequently pair the remote control with the TV in the Settings > Remote controls & accessories menu.

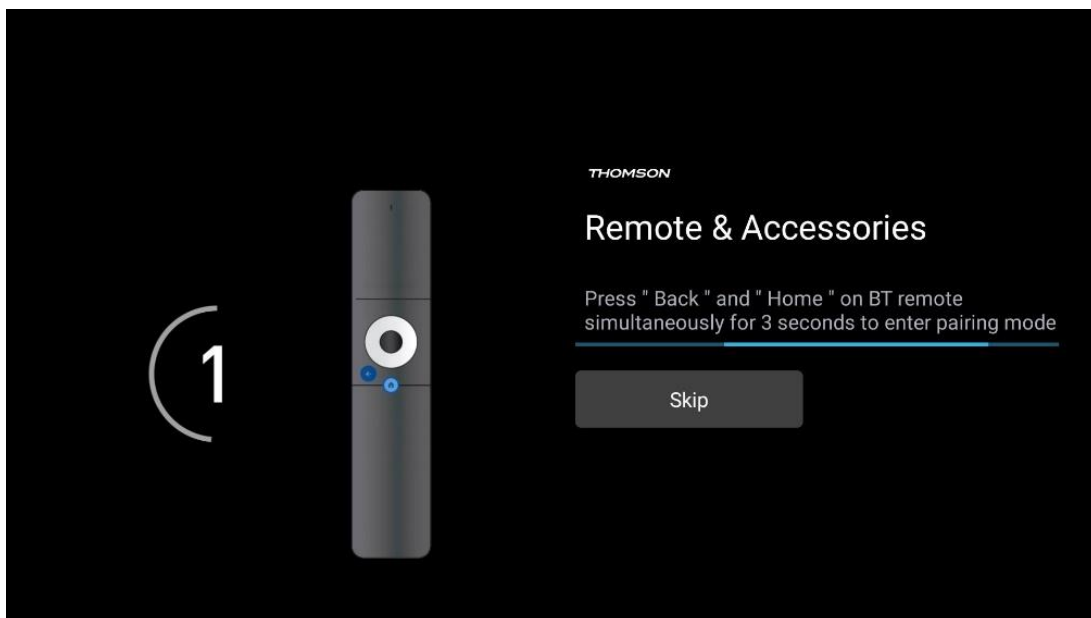

### 6.2 Language selection

Use up/down directional buttons to select system language, then press **OK** to confirm.



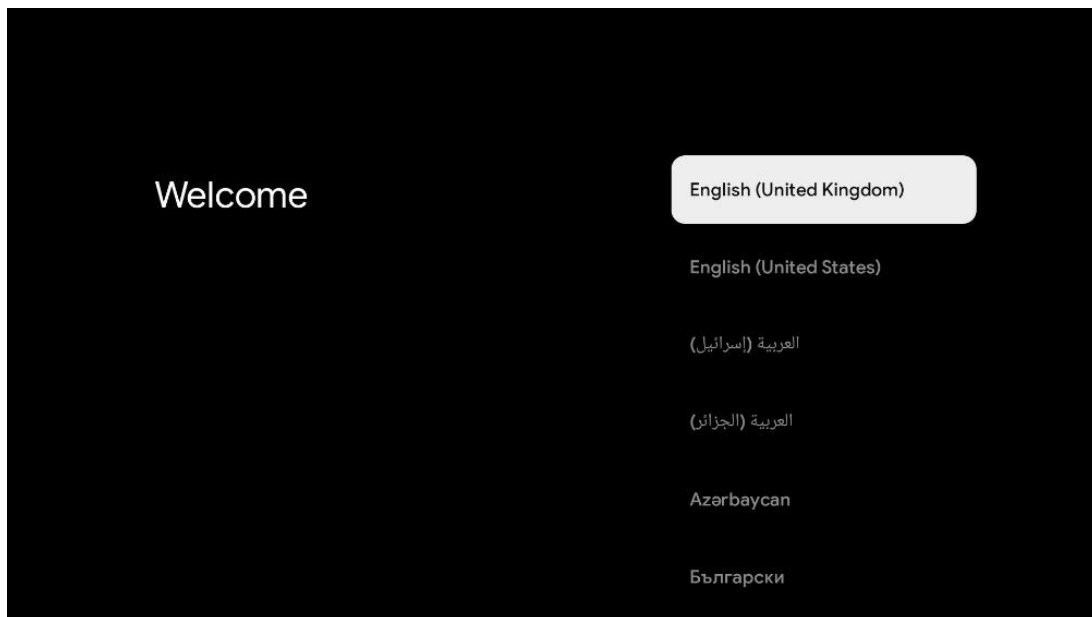

### 6.3 TV setup selection

Use up/down directional buttons to select your TV setup option, then press **OK** to confirm.

**Note:** If you select Set up Google TV, you will require a Google account to proceed with the installation. You can use an existing Google account or create a new one.

**Note:** Please select the Set up basic TV option if you only want to use your TV to watch TV or listen to radio programs via terrestrial antenna, cable, or satellite antenna and if you do not want to connect your TV to the internet so that you can watch video contents from streaming Apps like YouTube or Netflix.

The detailed installation of the Basic TV option is described in the menu chapter 6.5.

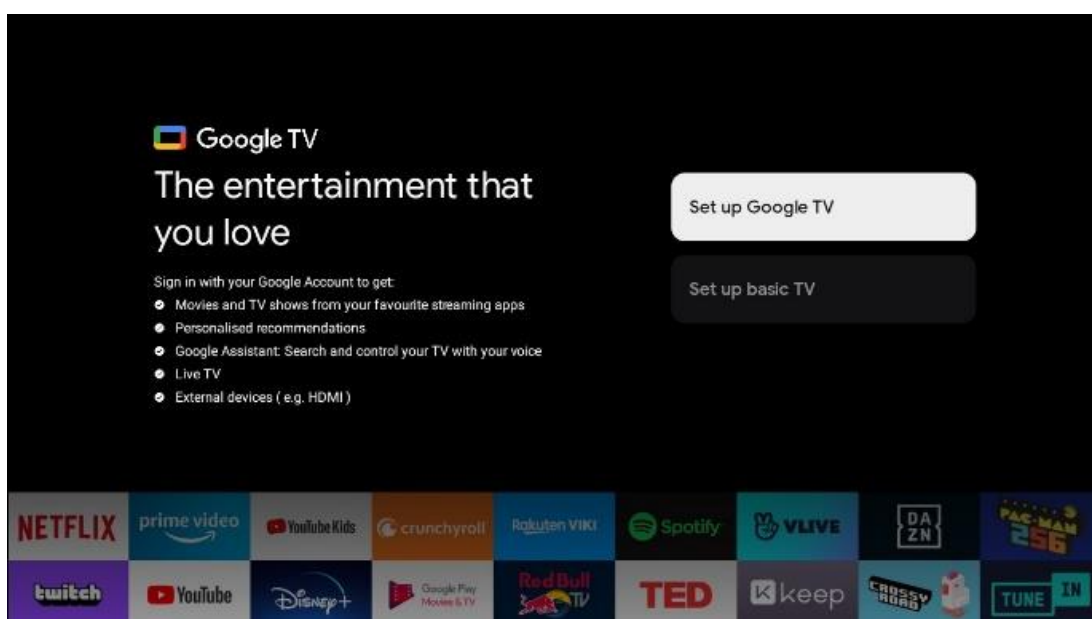

## 6.4 Set up Google TV

### 6.4.1 Set up with the Google Home App

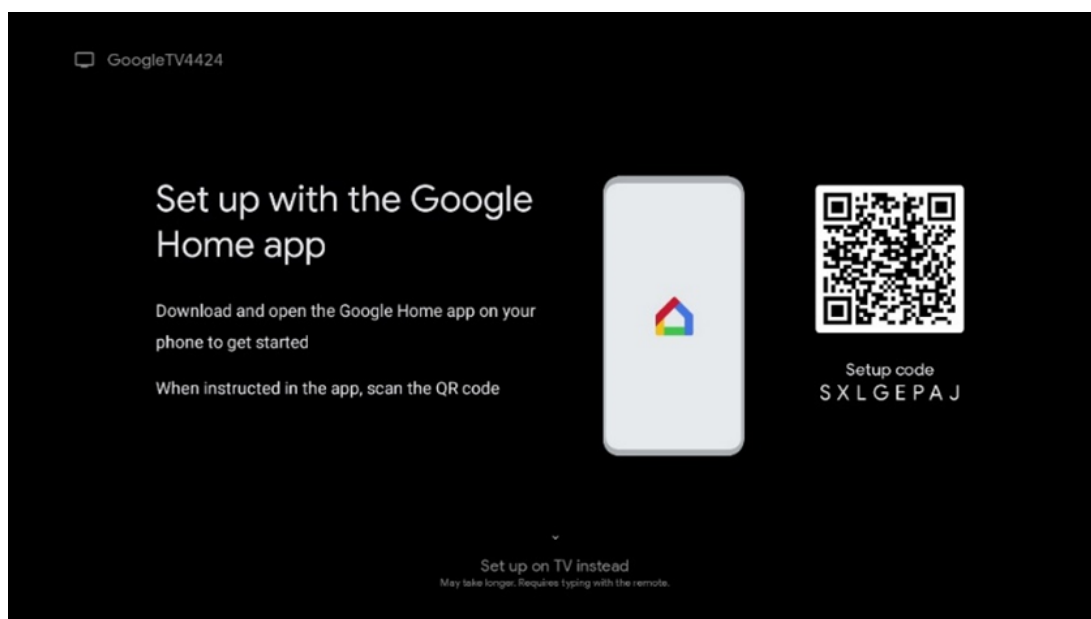

To set up with the Google Home app, it is necessary to have a mobile device (smartphone or tablet) with the Google Home app installed. To install the Google Home app, please scan the QR code on your TV or search for Google Home in the app store on your mobile device. If the Google Home app is already installed on your mobile device, open it and follow the instructions on your TV and mobile device. The setup of the TV via the Google Home application on your mobile device should not be interrupted.

**Note:** Some mobile devices with the latest Android OS version are not fully compatible with the installation of Google TV via Google Home App. Therefore, we recommend the installation option Set up on TV.

### 6.4.2 Set up on TV

To utilize the many advantages of your Google TV, your TV must be connected to the Internet. You can connect your TV to your modem/router wirelessly via Wi-Fi or by cable.

Your internet connection will be automatically detected and displayed if you have connected your TV with the modem/router directly to the cable.

If you want to connect your TV to the internet wirelessly via Wi-Fi, press the up/down directional buttons to select the desired WLAN network, enter the password and then press Confirm to establish the connection. If you select Skip because you want to set up your TV as a Basic TV, you can configure the internet connection later in the TV Settings menu.

### 6.4.3 Sign-in with your Google account

To sign in with your Google account, enter your email address and your password.

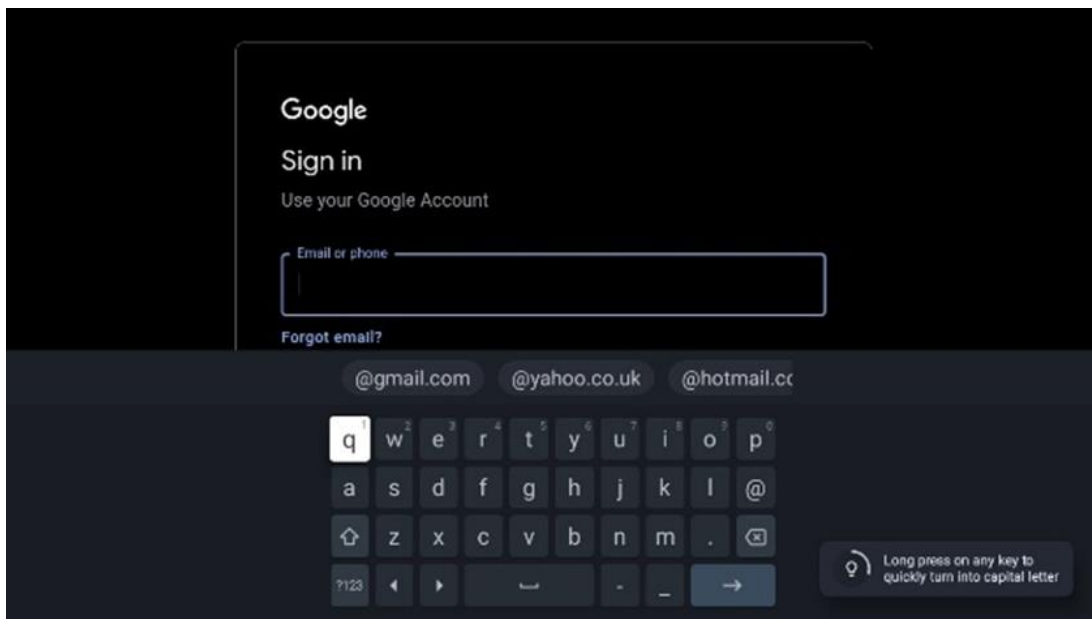

### 6.4.4 Google Terms of Services

Before you continue, please take the time to read the General Terms and Conditions, the Terms of Use for Games, the Privacy Policy, and the available Google services. You declare your agreement with these services by clicking on Accept.

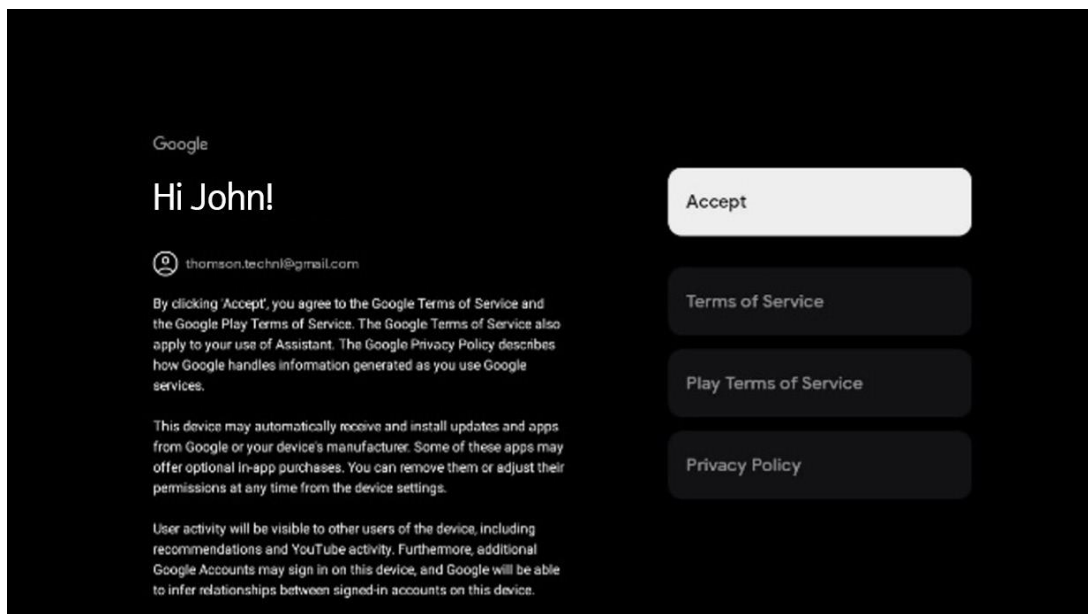

Select Accept to confirm if you want your location identified on your Google Privacy Policy and agree to automatically send diagnostic information to Google to help improve your Google experience.

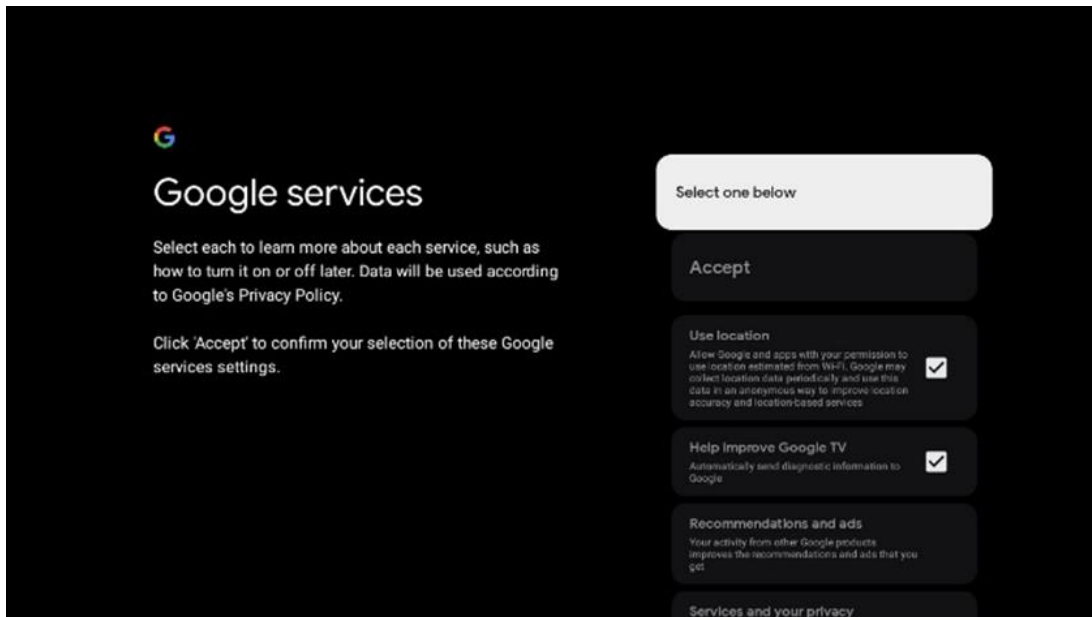

### 6.4.5 Confirm or reject Google services and features

Carefully read through the services and functions that your TV offers. If you don't want to activate one or more of the offered services, you can reject them by clicking No, thanks.

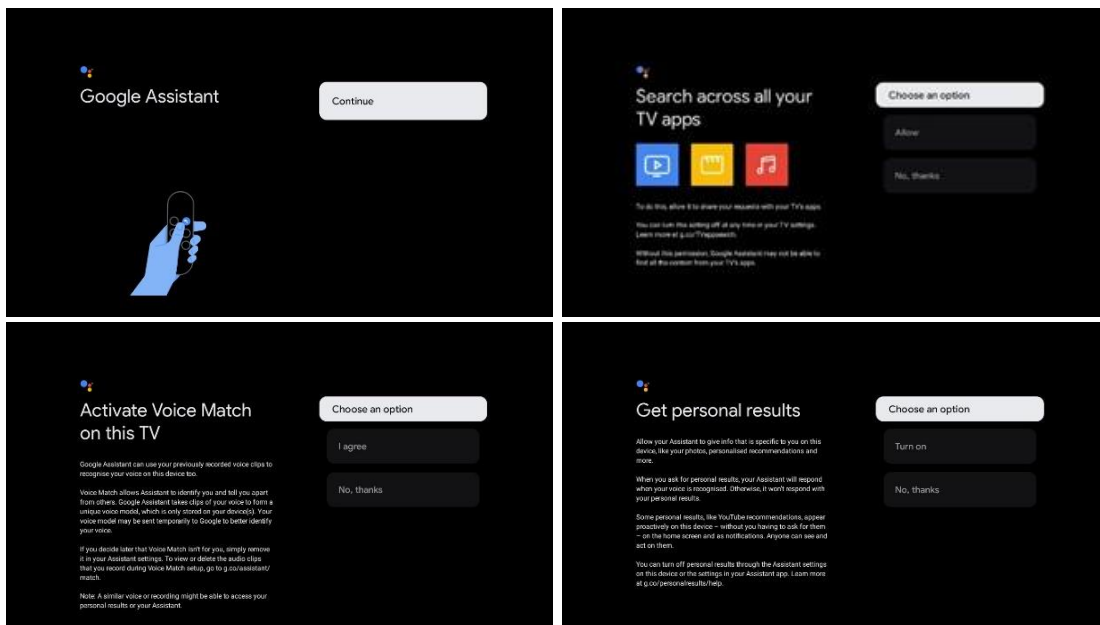

### 6.4.6 Choose your subscriptions

Select which streaming applications you would like to install automatically. These might be applications for which you already have a subscription for, or applications suggested to you by Google.

Some applications are already pre-selected. You can deselect them, which means that they won't be automatically installed during the first set-up process.

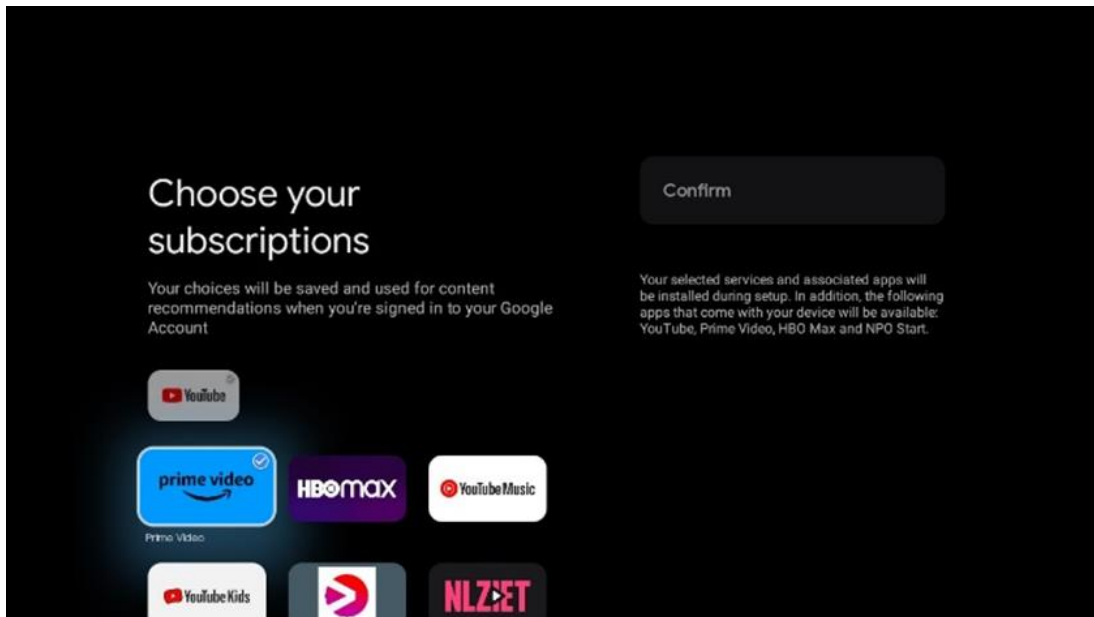

### 6.4.7 Region or country selection

Select the country you are located in to perform the installation correctly. This is important because the availability in the Google Play store and installation procedure of many applications depends on the geographic location (Geo-location). This is why certain applications are available for one country and not for others.

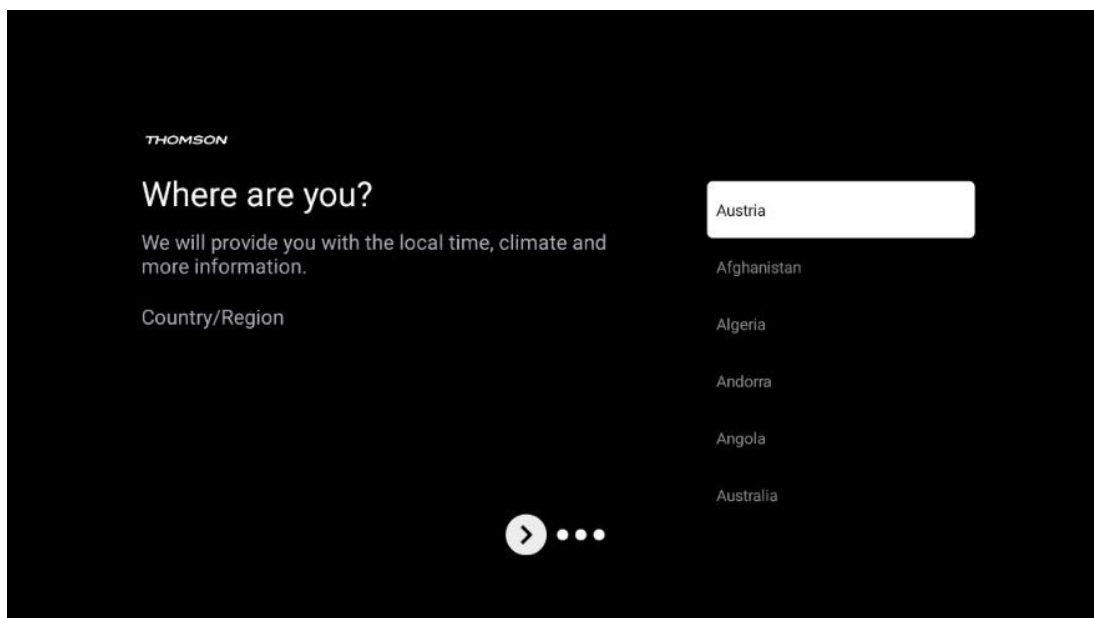

## 6.4.8 Disclaimer

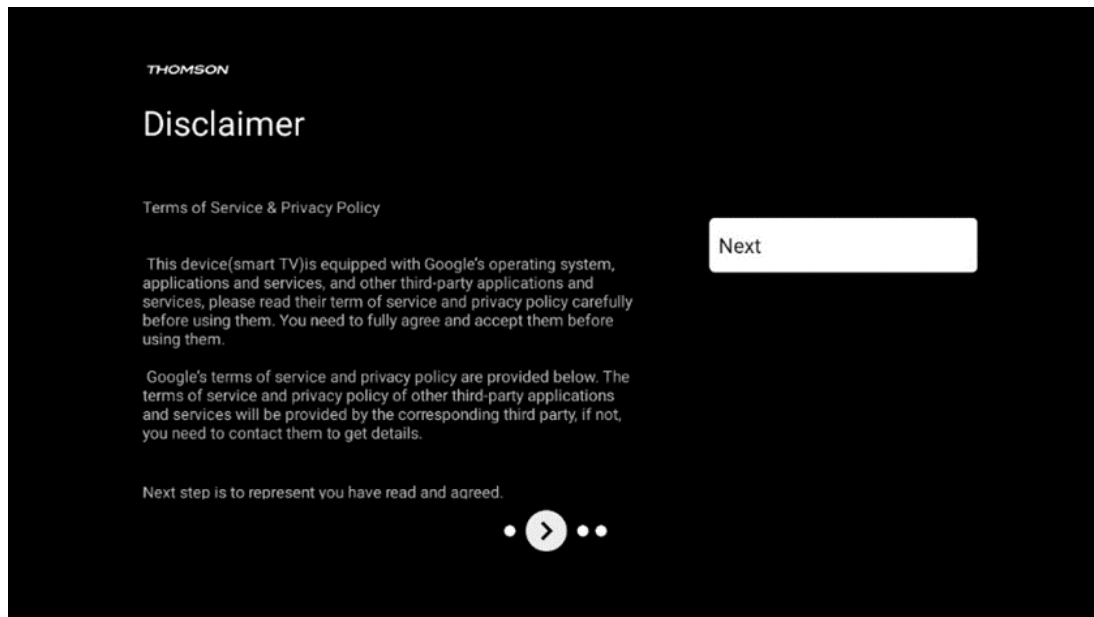

Please carefully read through the Terms of Service & Privacy Policy and accept them by clicking on Next.

## 6.5 Set up basic TV

Please select the installation option Set up basic TV if you only want to use your TV to watch TV or listen to radio programs via terrestrial antenna, cable, or satellite antenna and if you do not want to connect your TV to the internet so that you can watch video contents from streaming Apps like YouTube or Netflix.

### 6.5.1 Select your Wi-Fi network

If you do not want to watch content from streaming services like Netflix or YouTube, select the Skip option at the end of the list of available Wi-Fi networks.

### 6.5.2 Region or country selection

Select the country you are located in to perform the installation correctly. This is important because the availability in the Google Play store and installation procedure of many applications depends on the geographic location (Geo-location). This is why certain applications are available for one country and not for others.

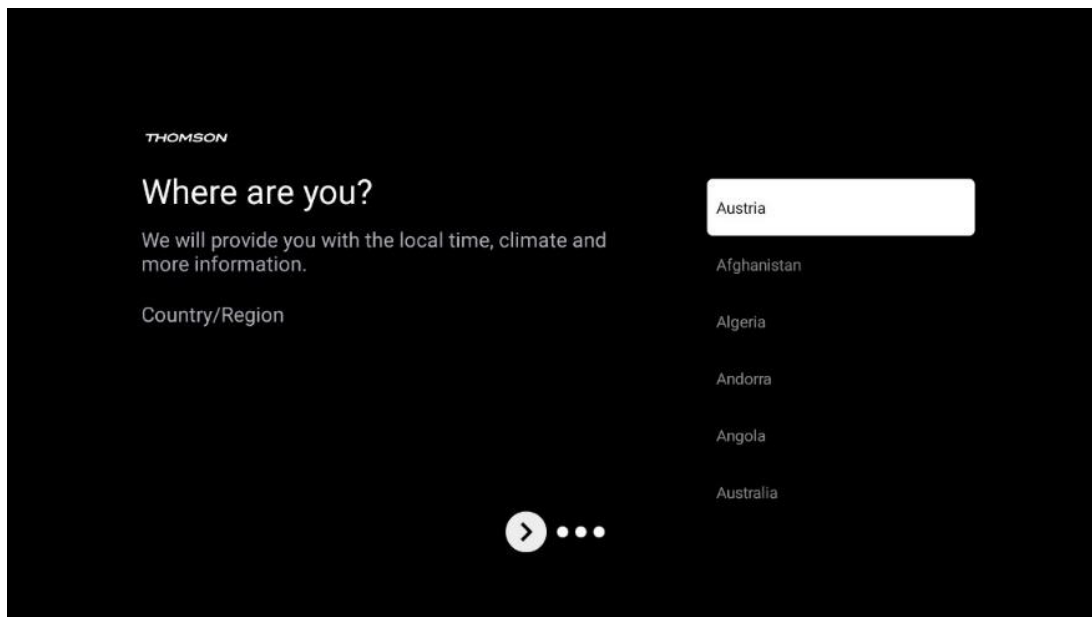

### 6.5.3 Disclaimer

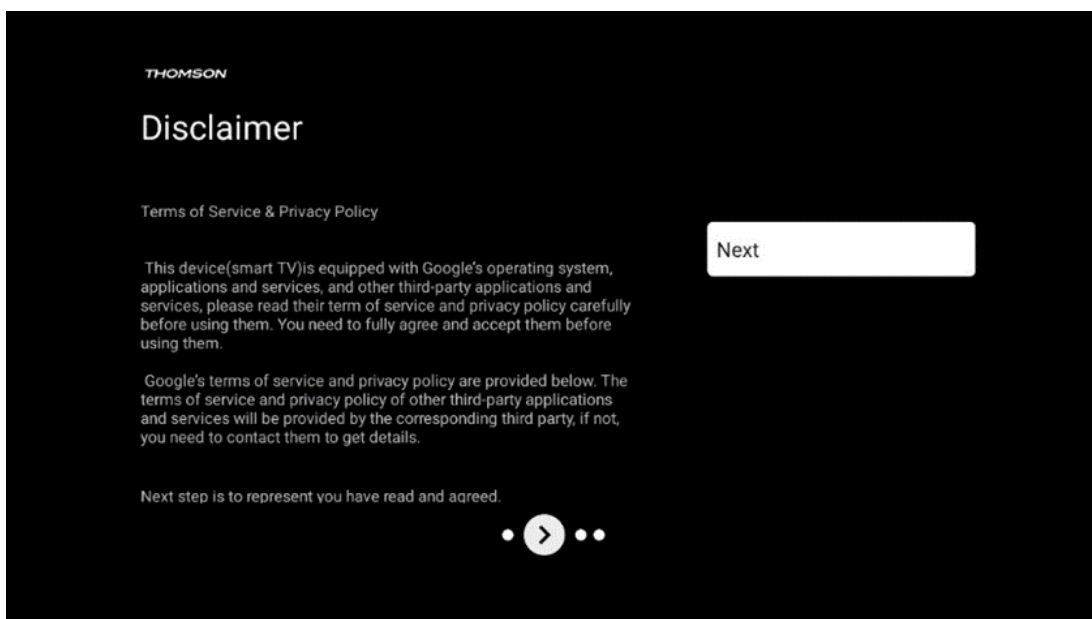

Please carefully read through the Terms of Service & Privacy Policy and accept them by clicking on Next.

## 6.6 Parental Control

In the first installation process you will be able to create a parental control using "Children's features" option or later any time in the "Settings" > "Accounts and sign-in" menu > "Add a child". Here you can set up a profile for your children on your Google TV, giving them access only to selected, child-friendly applications, and you can determine which of the pre-installed applications on the TV the children can access.

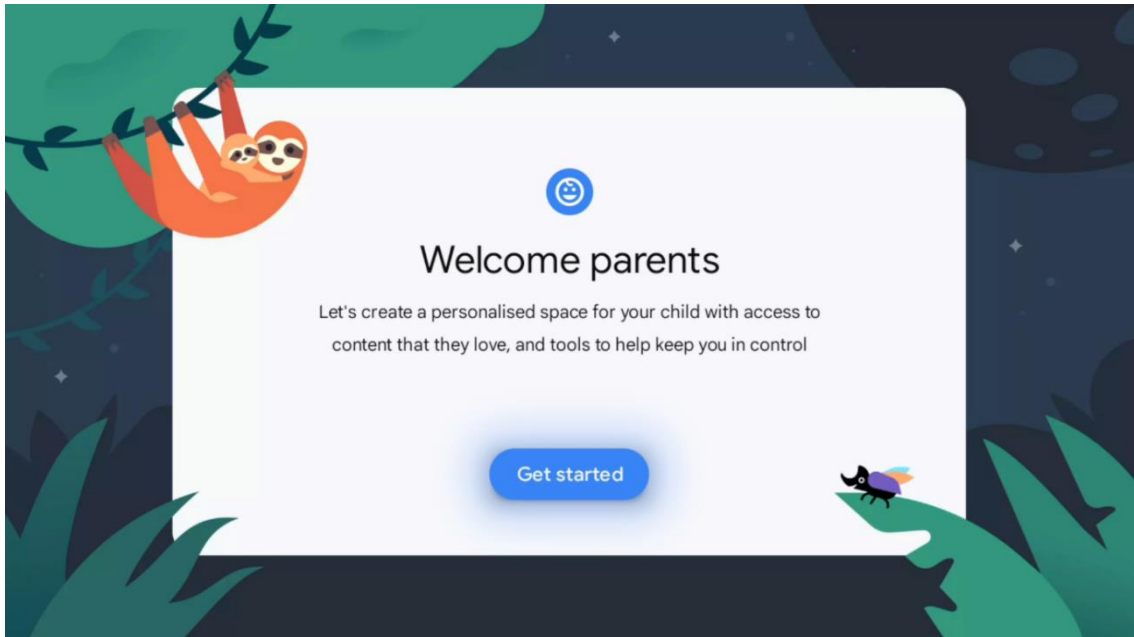

To create a child profile or to add another child profile, follow the installation steps and instructions on the screen. During the installation process, you will also be informed by Google about the child profile's features.

## 7 Channel installation

Select your TV reception type Tuner to install TV/Radio channels. The reception type options Terrestrial Aerial, Cable and Satellite are available. Highlight the available TV signal reception type option and press **OK** or click on the right directional button to continue.

If you select Skip scan, you can finish the first installation process of the TV without installing the TV channels. You can subsequently install the TV channels in the TV Settings Menu.

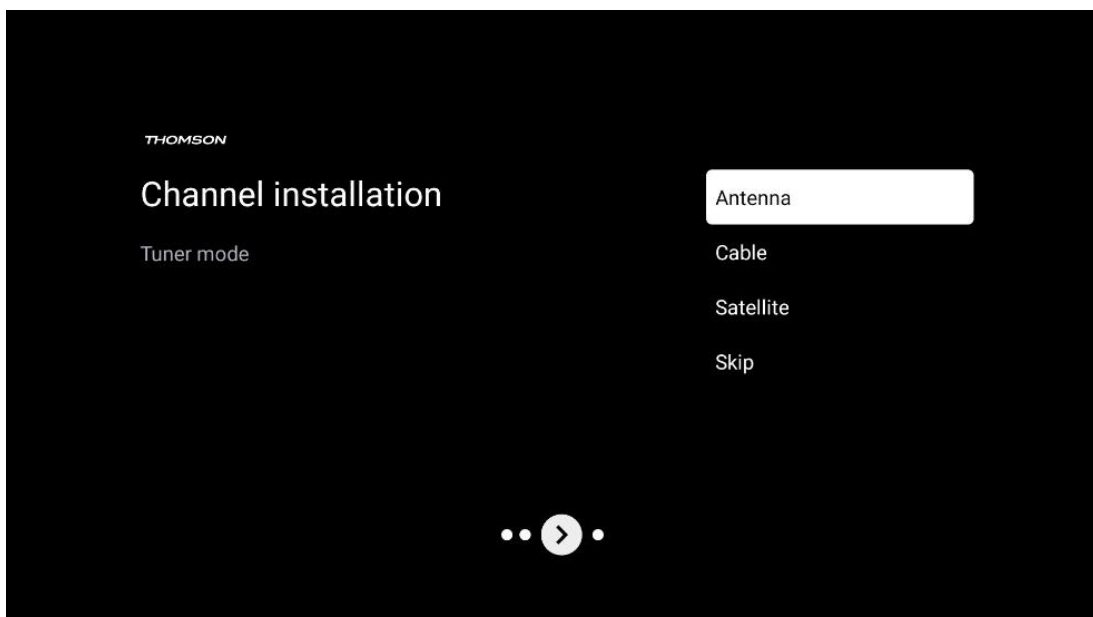



## 7.1 Tuner mode

### 7.1.1 Antenna

If the Antenna option is selected, the TV will search for digital terrestrial and analogue broadcasts. On the next screen highlight the Scan option and press **OK** to start the search or select Skip Scan to continue without performing a search.

**Operator Scan:** If available, the available cable operators will be listed on the screen. Highlight the desired operator and press **OK**. Select Start and press **OK** to perform the channel scan.

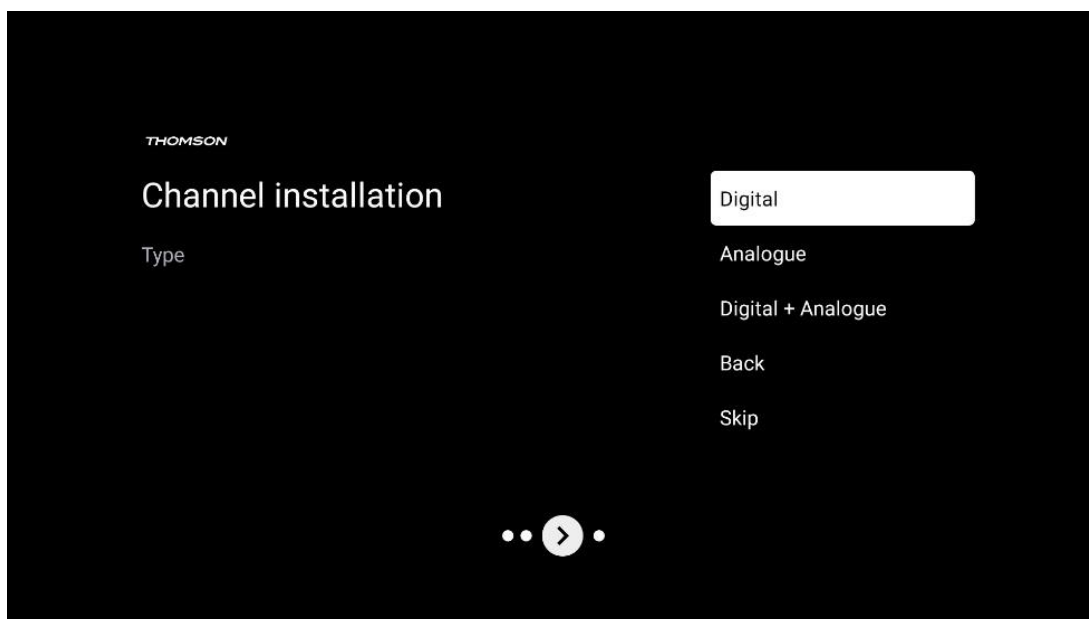

## 7.1.2 Cable

If the Cable option is selected, the TV will search for digital cable channels.

In most cable channel networks, only digital channels are available. Select Digital to continue the scan.

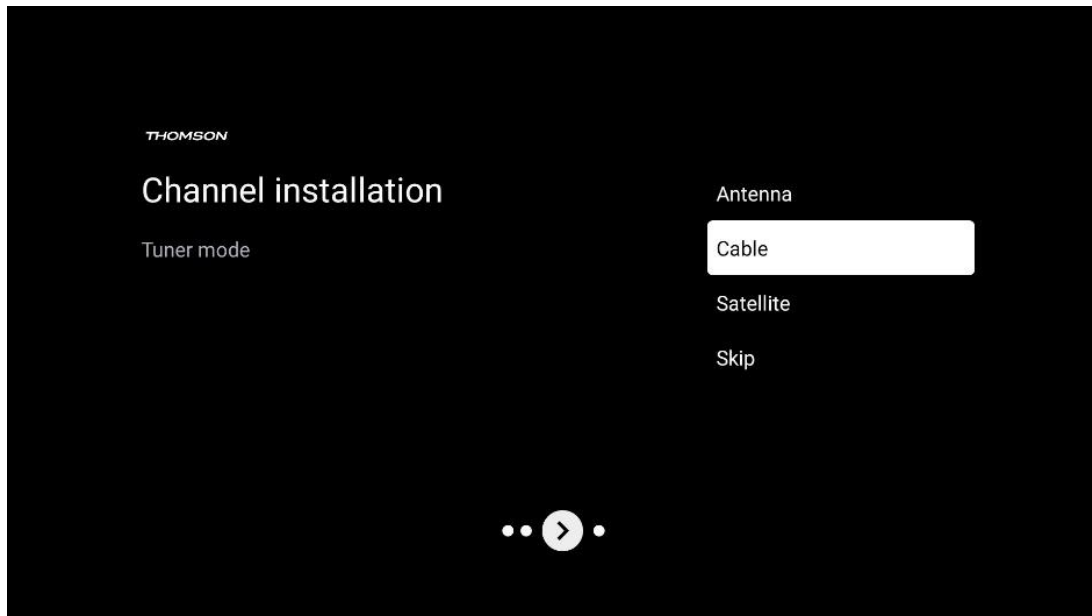

**Operator Scan:** If available, the cable operators will be listed on the screen. Highlight the desired operator and press **OK**. Select Start and press **OK** to perform the channel scan.

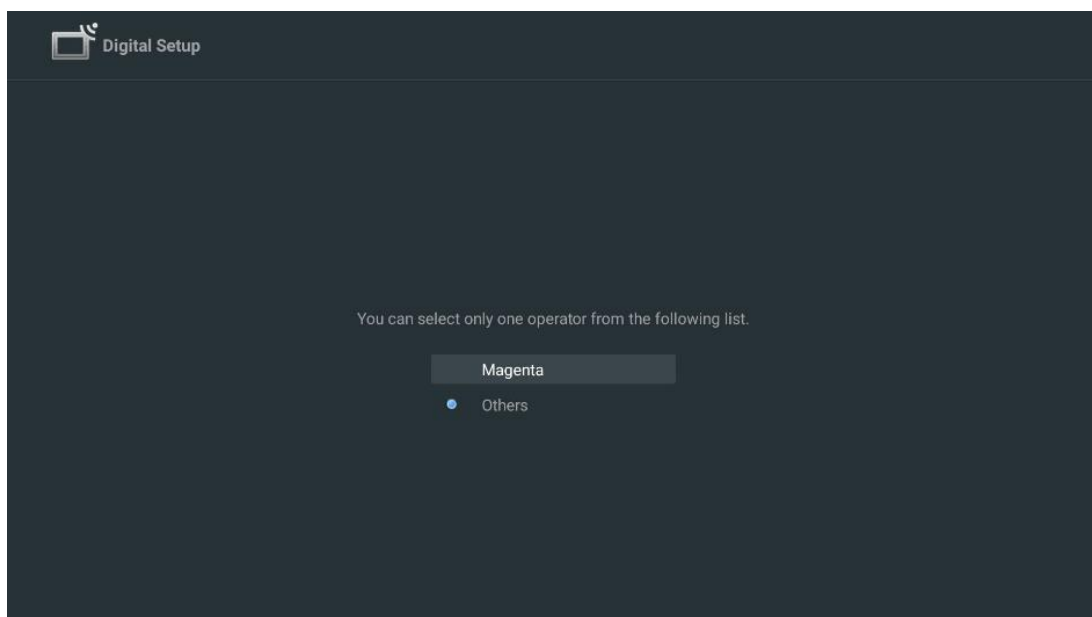

**Others:** Select the option Others if your cable operator is not listed or if your TV is connected to a local cable system. Select Scan Type and press **OK** to display the scan options.

**Full scan:** An automatic full search searches the entire frequency band; this should be selected if not all channels were found during a network search.

**Quick scan:** A quick search will be started, which will bring the channels into a pre-sorted order. With this type of search, it is necessary to enter the network ID and center frequency.

**Network scan:** With a network search, a complete and up-to-date channel list of a provider is transmitted, so the receiver recognises all channels, which is preferable for cable TV operators. With this type of search, it is necessary to enter at least the network ID.

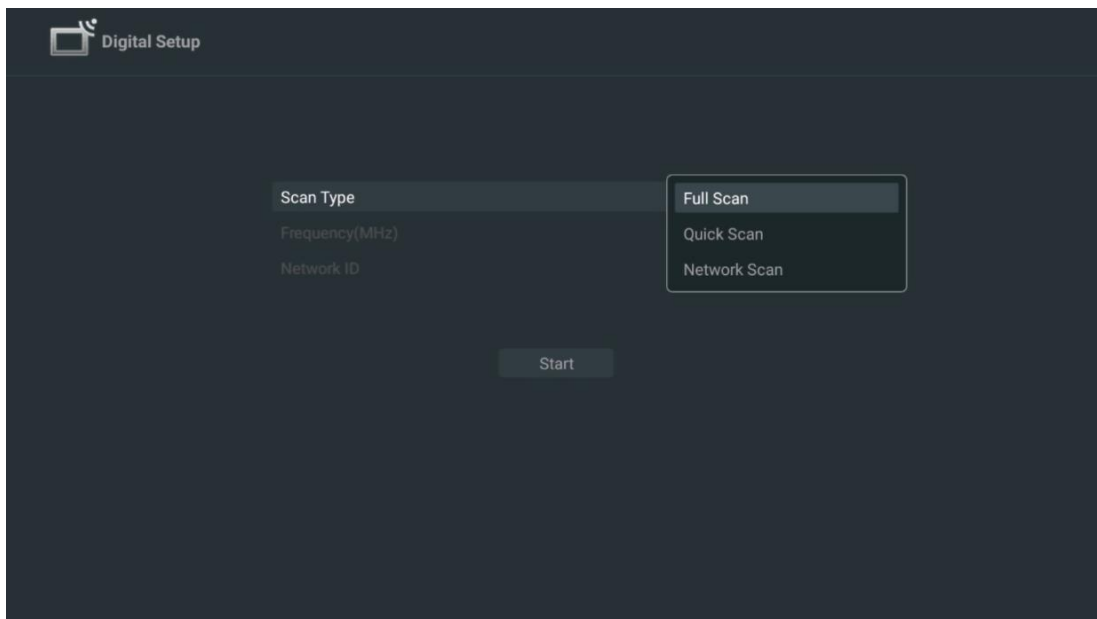

Select Skip Scan to continue without performing a search.

### 7.1.3 Satellite

**Note for the installation of satellite channels for Thomson TVs installed in Austria or Germany:**

Our Thomson TVs have the Satellite Channels Preset function, which can only be selected and executed during the initial installation of the TVs. This function is only available if Austria or Germany was selected as installation countries during the initial installation.

This function will only be performed during the initial installation of the TV when you install the satellite channels.

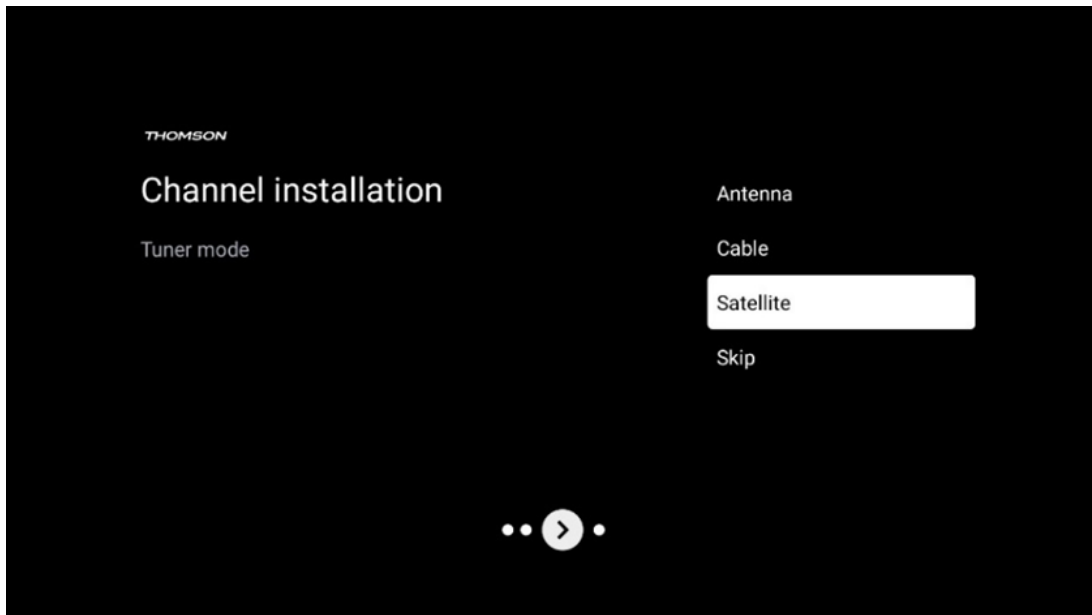

To activate it, follow the installation steps below:

1. Tuner mode menu - select Satellite as the installation option.
2. Select Satellite Channels Preset
3. Press the **OK** button to confirm your selection.

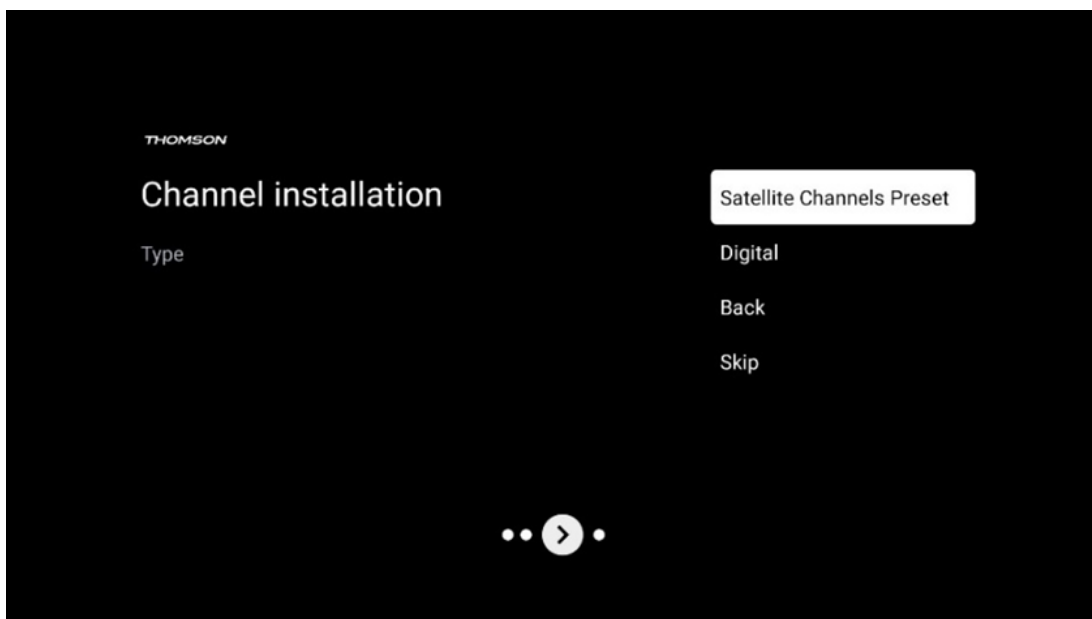

### **Satellite Installation**

Select the installation option Digital to continue with the installation of the satellite channels.

### **M7 Operators**

The M7 Operators are Pay-TV operators that offer culture- and language-specific packages for eight countries: Netherlands, Belgium, Germany, Austria, Czech Republic, Slovakia, Romania and Hungary.

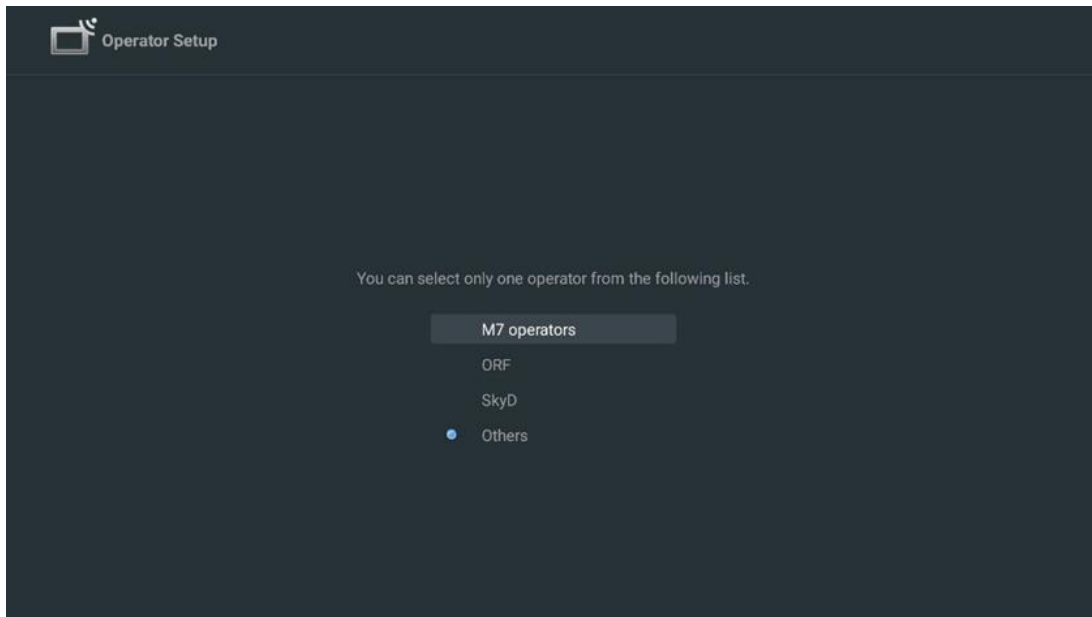

If your TV is connected to a satellite system for reception of multiple satellites, select Yes and press **OK** to continue.

If you are connected to the satellite system with satellite reception, select No and follow the installation instructions on the screen.

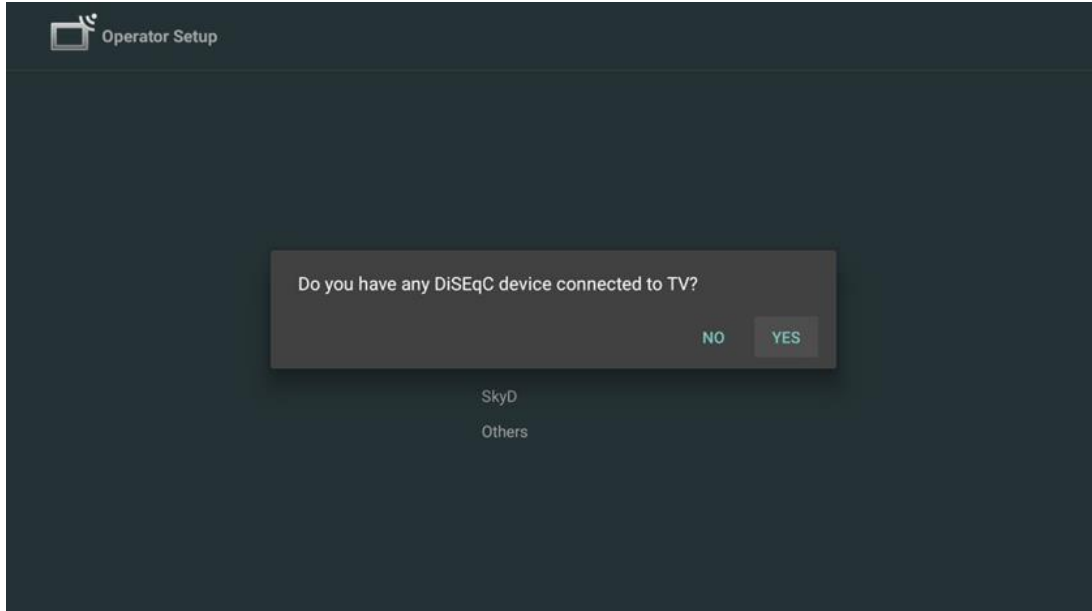

To perform an automatic DiSEqC port detection, press the Yellow button on the remote control and then press the Blue button to start the channel scan.

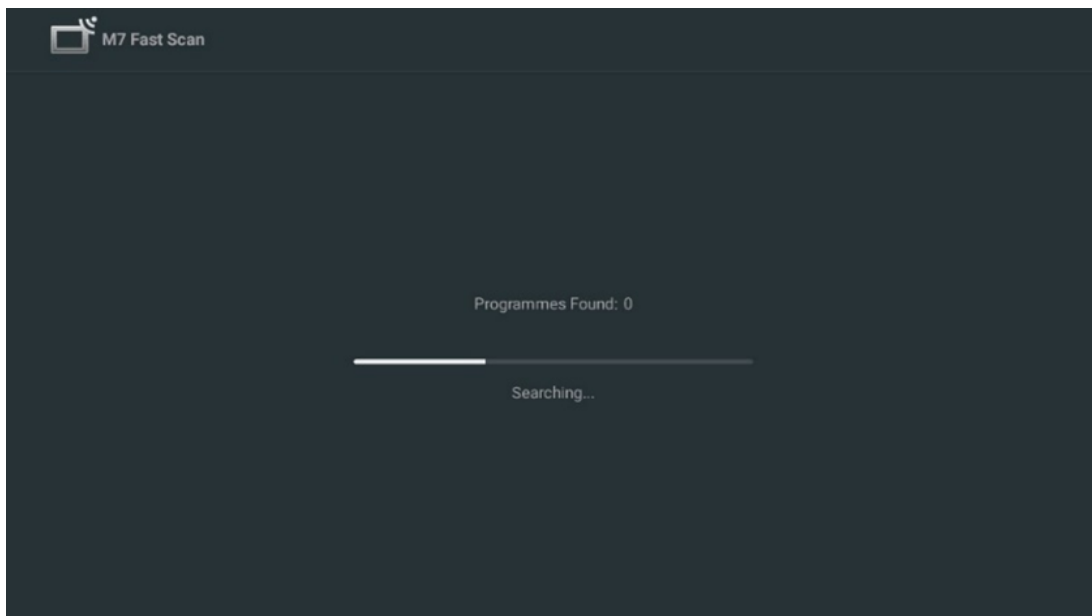

If you want to cancel the ongoing search, press the **Back** button. The channels that have already been found will be stored in the channel list. When the initial setup is completed, results will be displayed. Press **OK** to finish the setup.

### **Local satellite operator installation**

If available, select an operator from the list for your installation location country. The channels will be sorted according to the LCN channel sorting of the selected operator.

### **Others**

Select this installation option if you want to program the satellite channels individually. Your TV screen is divided into three columns. Press the Up/Down and Left/Right directional buttons on your remote control to move through the columns.

**1<sup>st</sup> Column - Satellite:** Choose your preferred satellite from the list and use the **OK** button to select it.

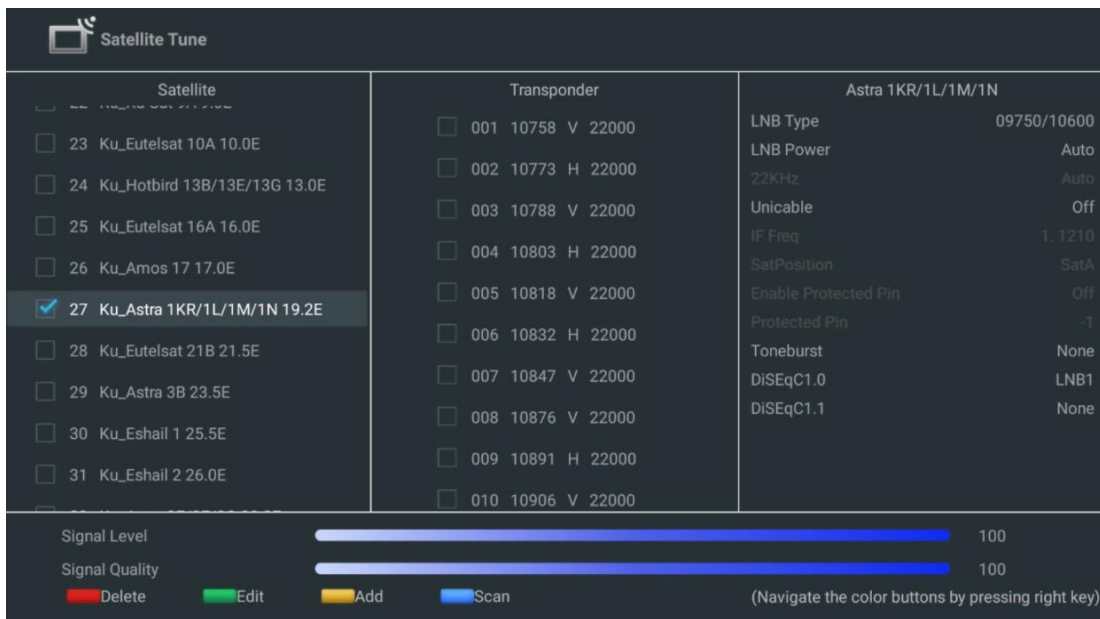

**2<sup>nd</sup> Column - Transponder:** Select and mark individual transponders from the list if you do not want to scan the entire satellite but only certain transponders.

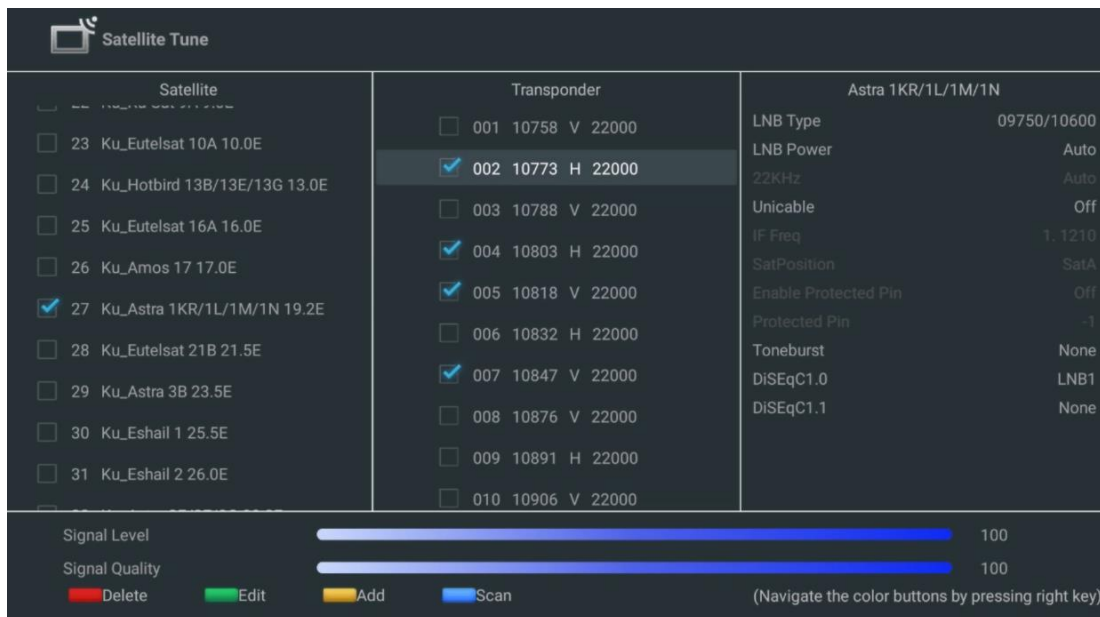

**3<sup>rd</sup> Column – Reception Characteristics:** Set the reception characteristics of the satellite you chose, for example Unicable On / Off or DiSEqC position of the selected satellite. By default, this column is set to single satellite reception.

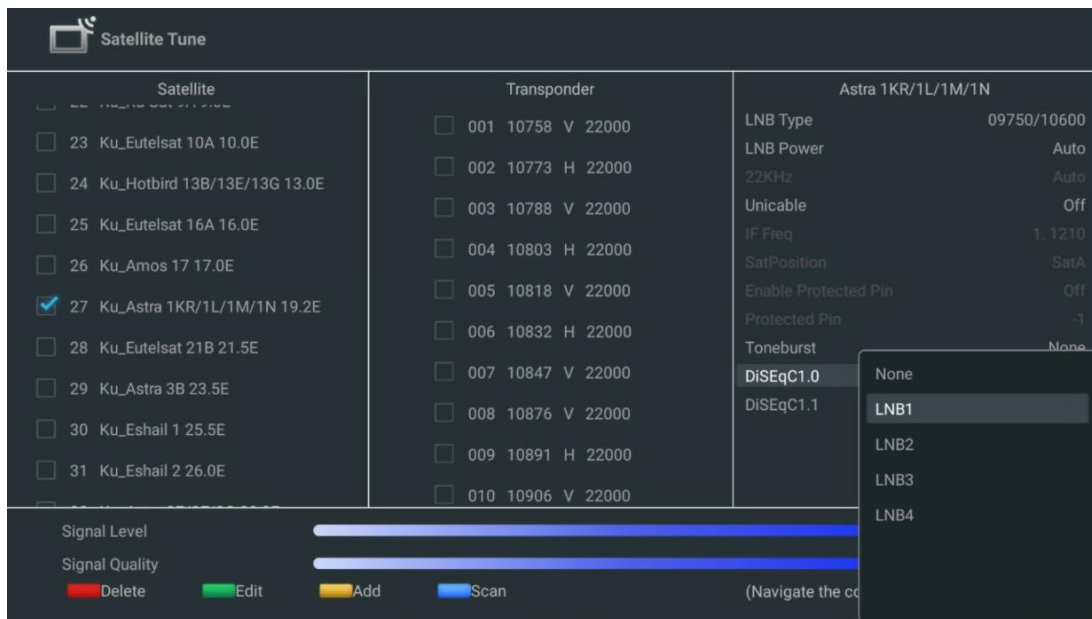

**Note:** The functionality of the **Color buttons** is labelled at the bottom of the screen.

Press the Red button to delete a Satellite or Satellite transponder from the list.

Press the Green button to edit a Satellite or Satellite transponder from the list.

Press the Yellow button to add Satellites or Satellite transponders.

Press the Blue button to start the search for satellite broadcasts from a satellite or from a single satellite transponder.

**Note:** If the signal level and quality are not displayed for the selected satellite, use the directional buttons to choose another satellite transponder from the list in the second column to verify satellite reception. This step may be necessary if the first transponder in the list is inactive. To continue searching the entire satellite, deselect the chosen transponders and press the Blue button to initiate the search.

When you have finished installing the satellite channels, you can install other tuners if your TV is also connected to aerial or cable TV or select Skip to continue the TV installation.



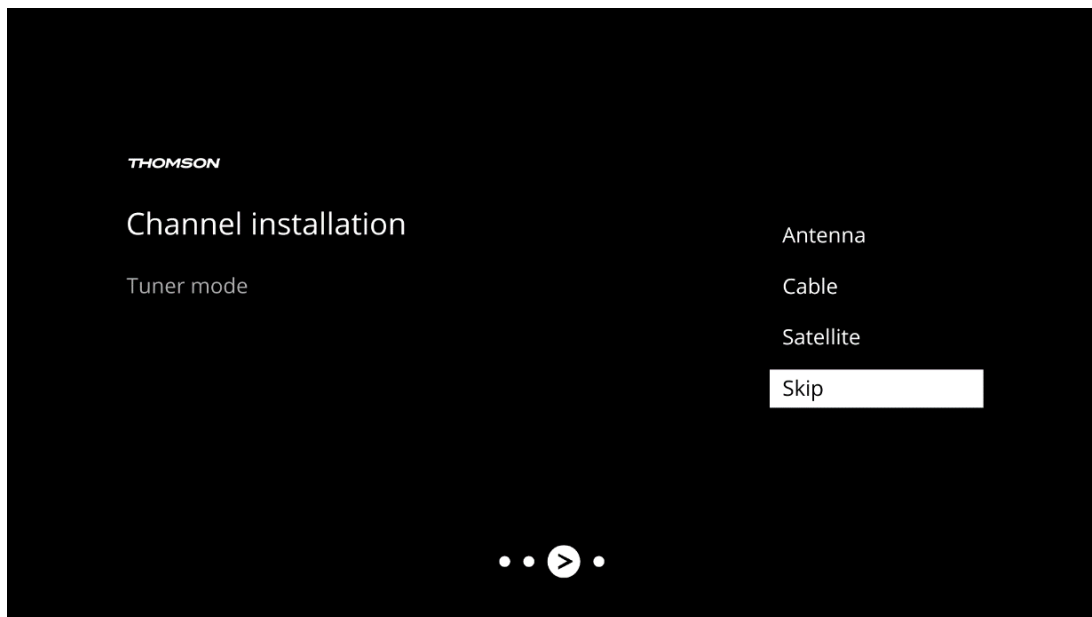

## 8 Check settings

Please, verify the tuner mode settings in the system settings. If you wish to change the country/region or the channel installation type, highlight the corresponding menu option and press **OK**. Refer to the previous installation paragraph to set up the settings.

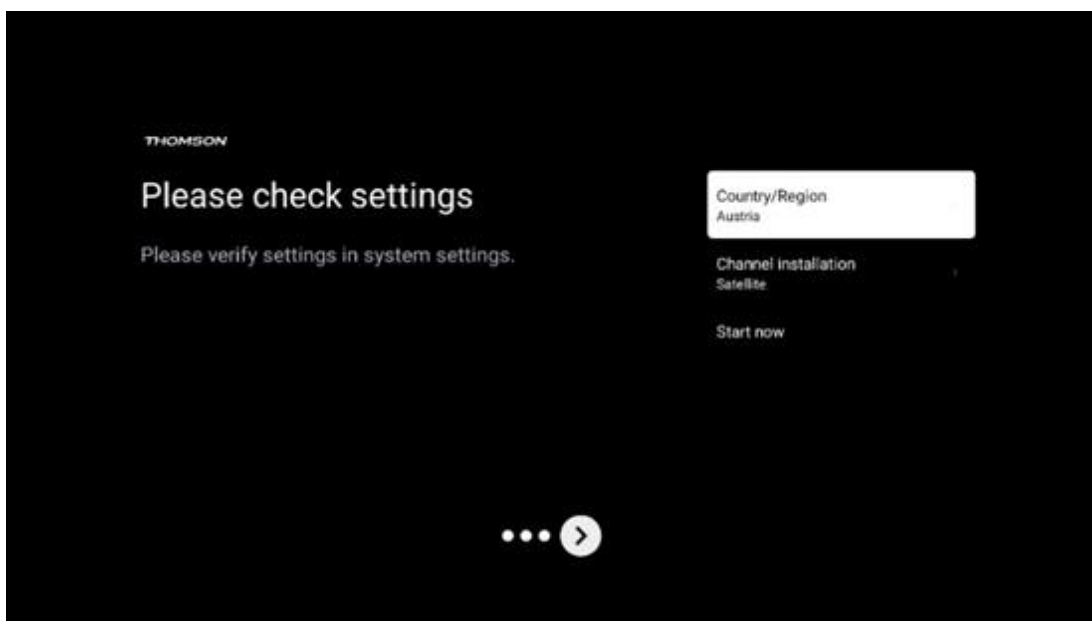

If the installation settings are set correctly, press Start now to proceed with the final installation,

Please, wait for the TV to complete the setup process. This can take a few minutes. This time is required to finish the final installation depending on your selected settings.

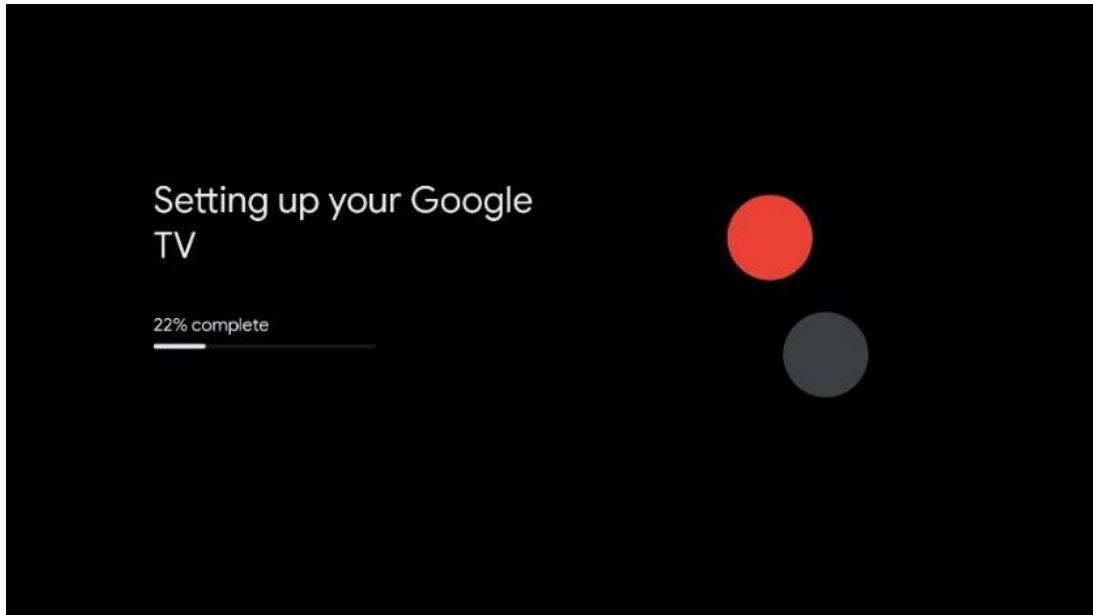

## 9 Home screen

The Home screen is the centrepiece of your TV. From the Home screen, you can launch any installed Application, launch the Live TV application to watch TV broadcasts, watch a movie from various streaming applications or switch to a device connected to the HDMI port. You can also exit the operation of any application at any time and return to the Home screen by pressing the Home button on the remote control.

In the first (Top picks for you) row, the streaming content of the streaming applications installed on your TV will be suggested according to your search criteria in your search history. Here you will also find the direct selection of the last TV input connection selected. In this line, on the first position, you will also find the selection box with the last Input source, if the HDMI CEC control function is enabled on this device.

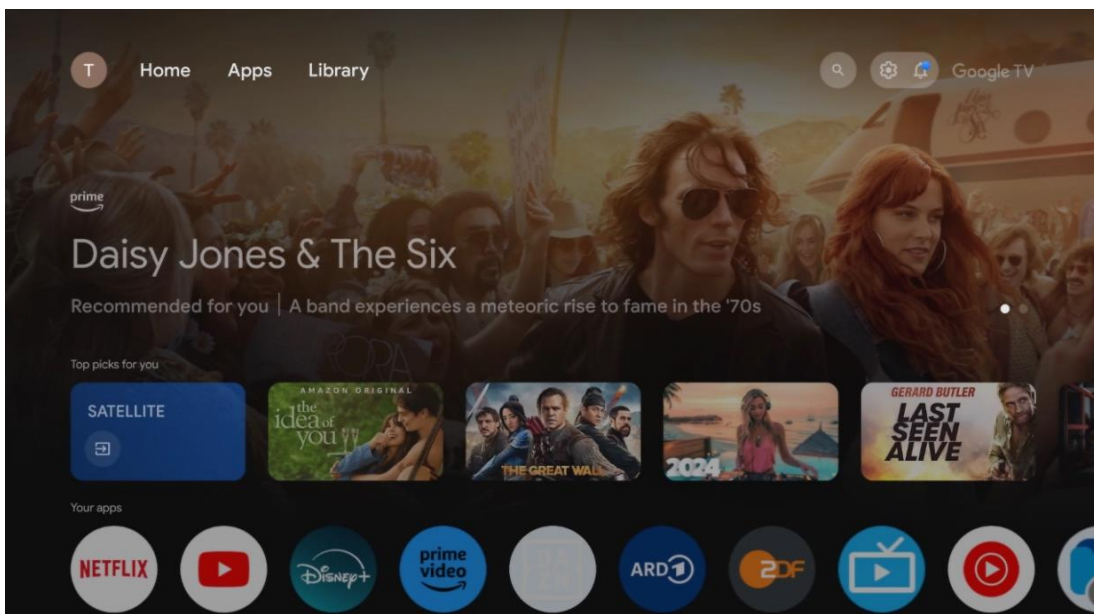

**Note:** Depending on the settings of your TV set and your country selection during the initial setup, the Home menu may contain different elements.

The second (Your apps) row is the row of applications. The most important applications for streaming services such as Netflix or YouTube as well as live TV and MMP (multimedia player) can be found here.

Select an application with the directional buttons on your remote control and confirm your selection with the **OK** button to start the selected application.

Select an application and press and hold the **OK** button to remove the selected application from the row of favorites, move it to a new position or launch it.

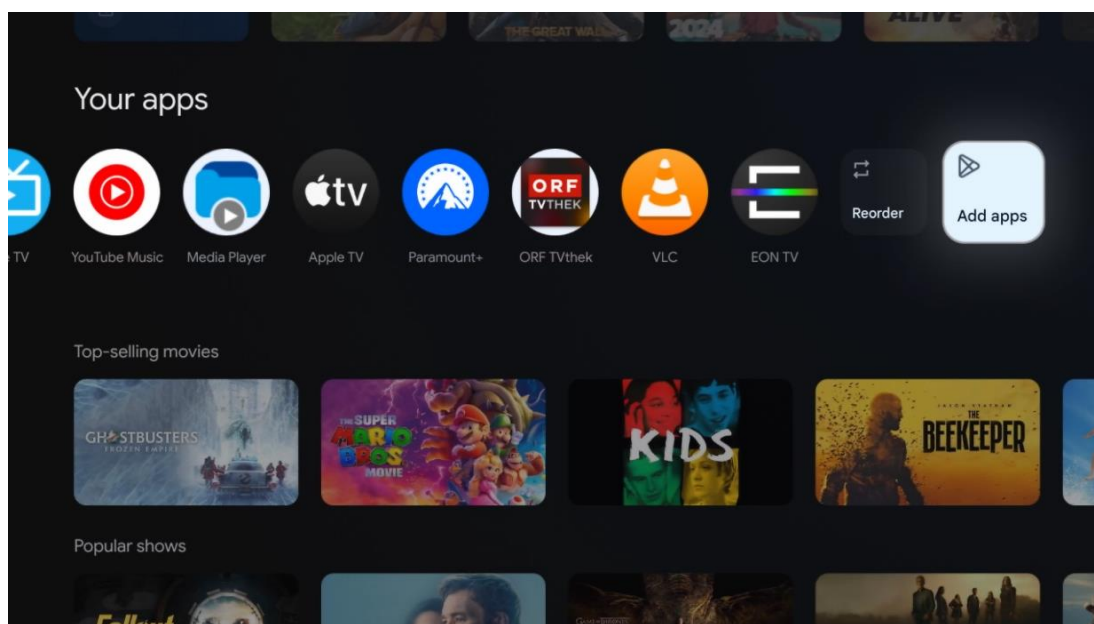

On the penultimate and last position in this row you will find boxes with the options Reorder and Add apps. Select these options to reorder the applications in this row or to add new application to this Favorite applications row.

The operation of the live TV application and the multimedia player is explained in a separate Menu chapter.

Further down on the home screen, you will find additional channels displayed by genre or streaming content category.

## 9.1 Google account

Navigate to your profile icon at the top left corner and press **OK**. Highlight the profile icon and press **OK**.

Here you can change your profile settings, add new Google accounts, or manage already existing accounts.

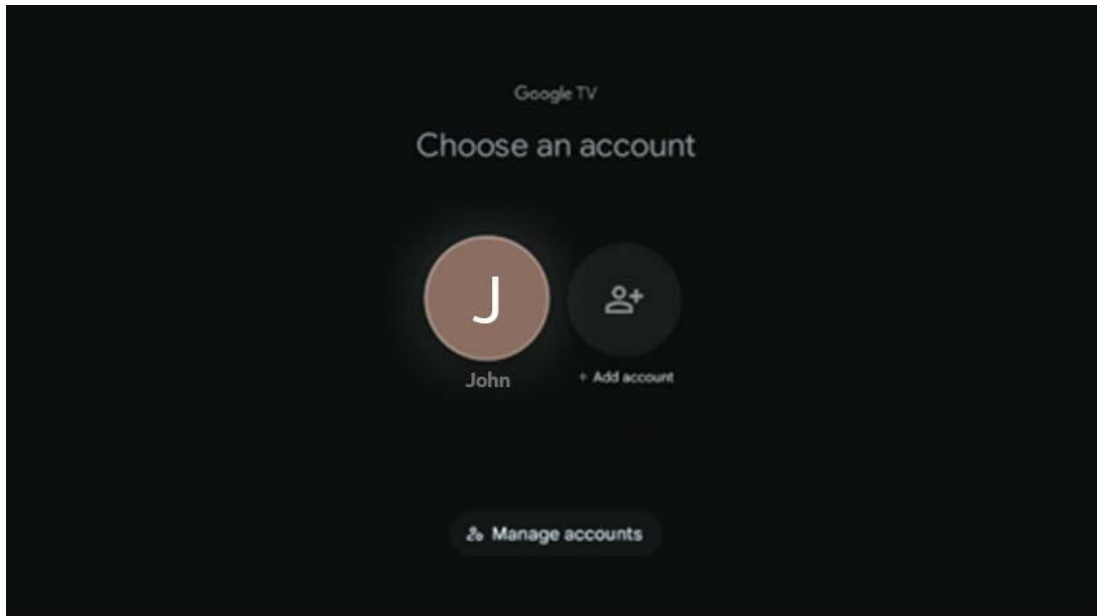

## 9.2 Apps

Select the Apps tab on the Home screen to display applications installed on your TV. To install an application, go to the search bar and type in the name of the app. This will start a search in the Google Play Store.

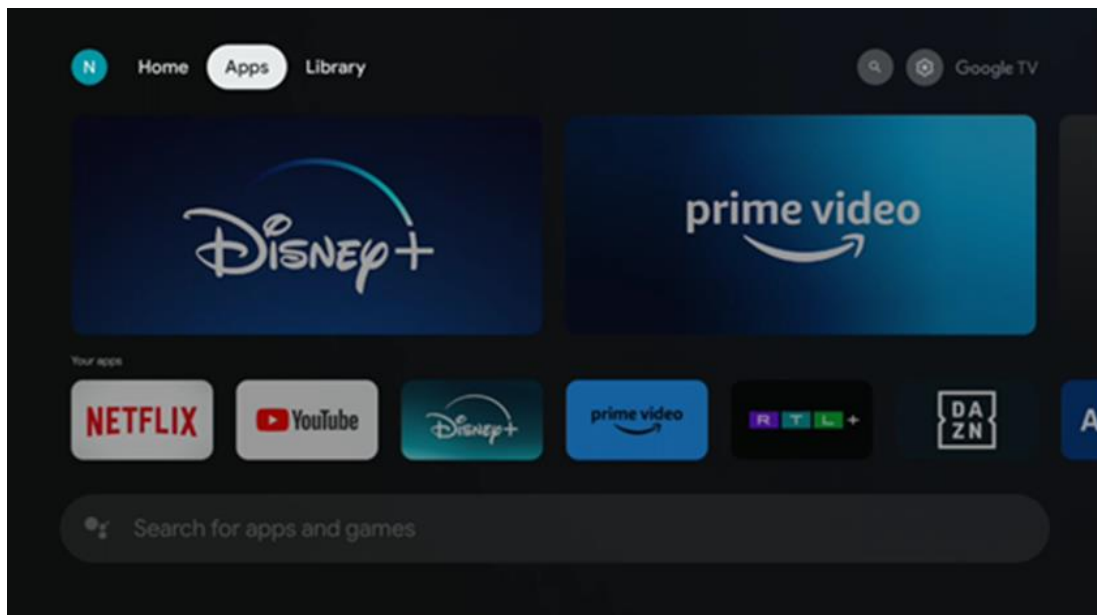

## 9.3 Library

Select the Library tab on the home page to play the streaming content you have already purchased or rented on your TV or mobile devices such as your mobile phone or tablet using your Google account.

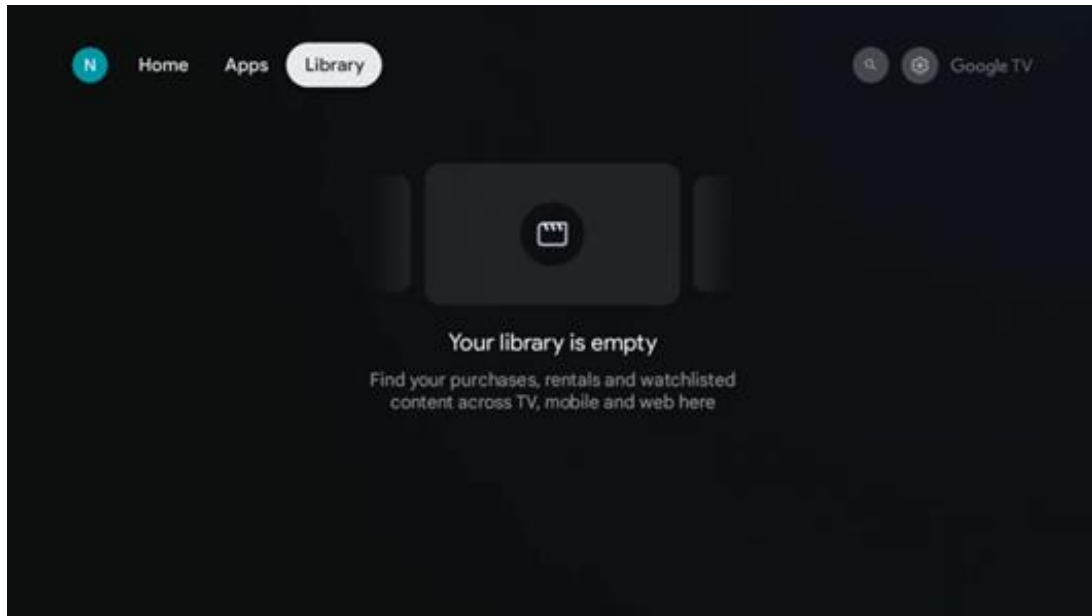

## 9.4 Google TV search

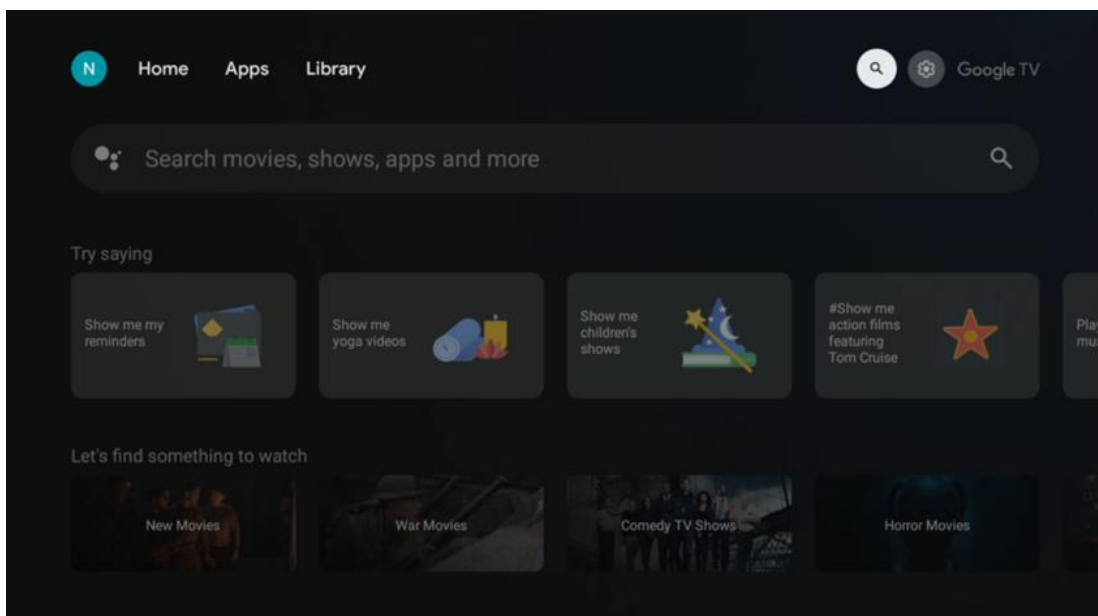

The search tools are located at the top right of the screen. You can either enter a word to start a search using the virtual keyboard or try voice search using the microphone built into your remote control. Move the focus to the desired option and press **OK** to continue.

Voice search – Press the microphone icon to start the voice search function. A Google voice search field appears at the top of the screen. Ask your question to Google and your TV will answer you. For local search terms it is important that the Menu language of the TV is set to the local language.

Keyboard search – Select the search bar and press **OK**. The virtual Google keyboard will appear on the screen. Type the question you want answered.

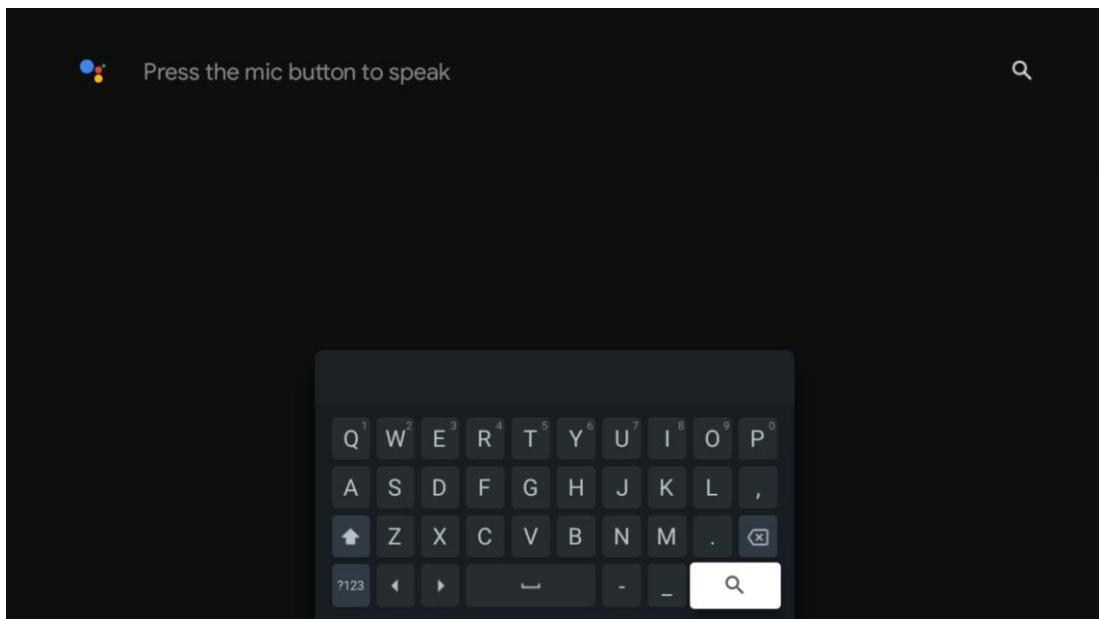

## 9.5 Notification

The notification button appears only when there is one or more unread notifications. To check them, please, navigate to the Settings icon, which will open the submenu. At the bottom of the submenu, you will be able to find all the latest notifications.

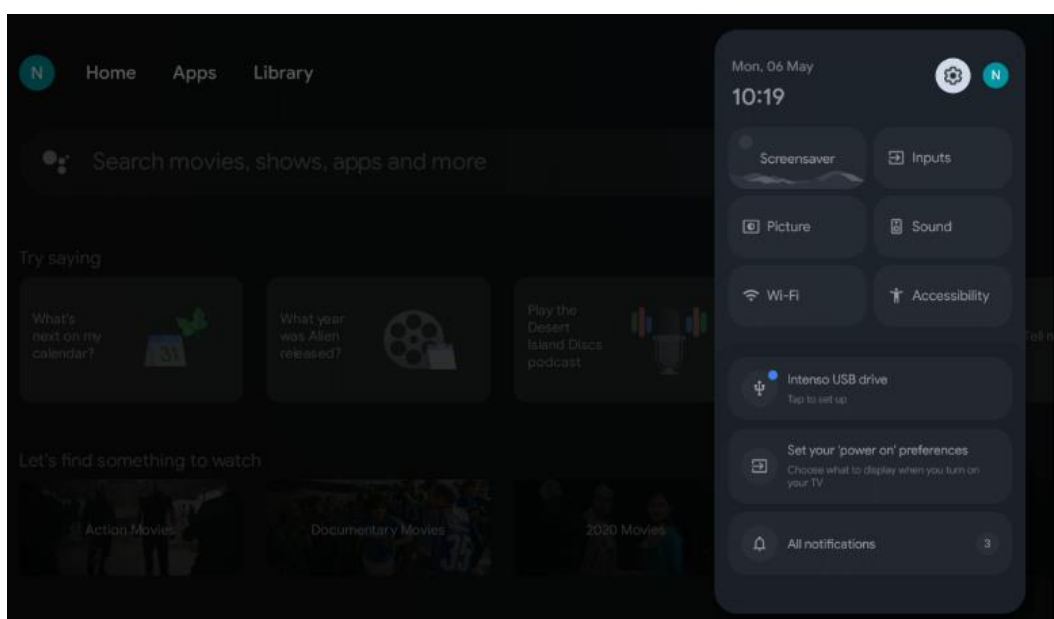

# 10 Settings

To see the full list of available settings, navigate to the Home Screen, by pressing the Home Screen button. Click on the Settings button in the right top corner.

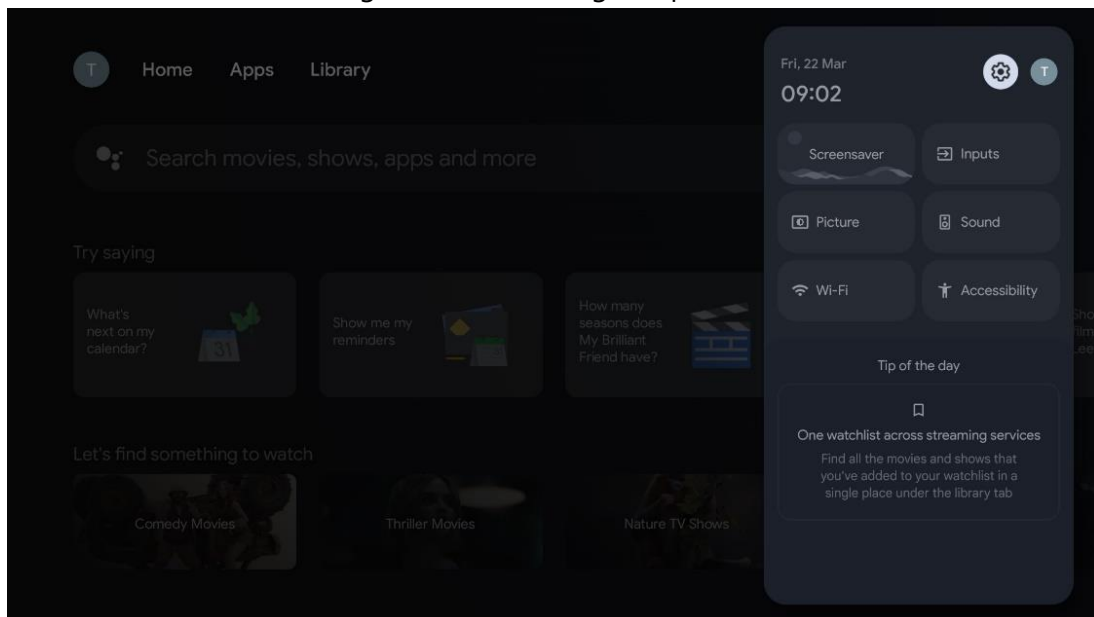

\* The above pictures are for reference only, please refer to the product for details.

## 10.1 Set your device name

In this menu you have the option to select the name of your TV from the list of suggested names. You can also assign a customized name for your TV.

This is important for operating the Chromecast function, so your TV will be identified with the correct name. By assigning the TV name, your TV will also be correctly identified in your home network.

## 10.2 Channels and inputs

Scan for available channels and available Inputs.

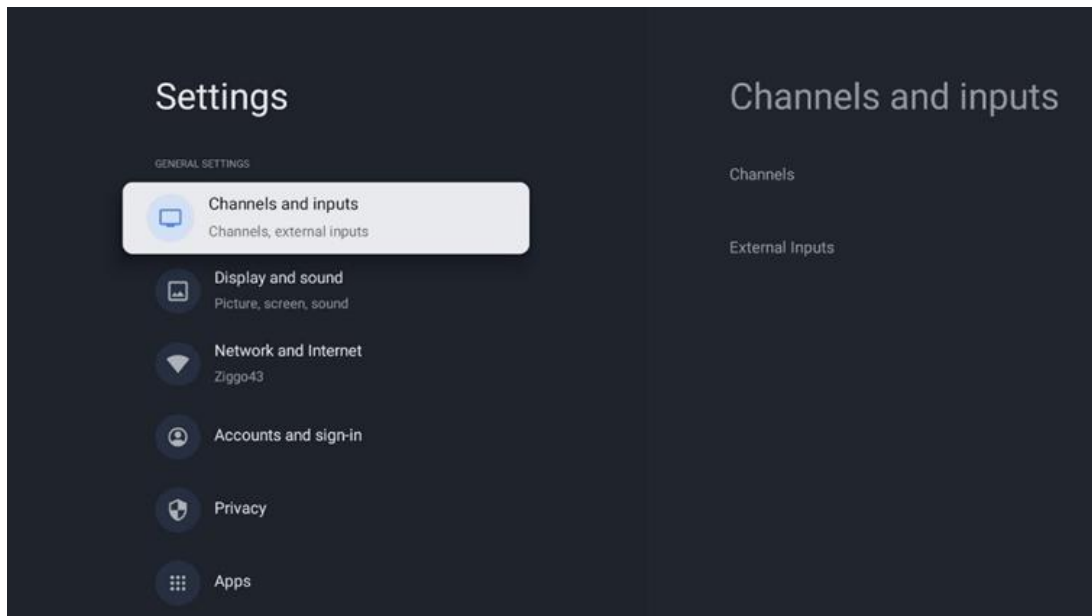

### 10.2.1 Channels

Select Tuner Mode and press **OK** to proceed. Then highlight one of the available options: Antenna, Cable or Satellite. Press **OK** and then press **Back** on your remote control to see the tuning options. Depending on your tuner mode choice, there will be various tuning options.

**Note:** Before scanning for channels, you might be required to enter your PIN code to proceed. You can set the PIN code by opening the Live TV App for the first time. You will need this PIN code for various TV functions, like re-scanning channels, setting parental controls or resetting the TV to factory settings. Alternatively, you might be asked to set a PIN code after completing the channel scan in the initial installation process.

**Note:** The further setting menu is relevant only if the last input is Satellite. For any other input there will be only Channel Scan and Virtual Keyboard.

#### 10.2.1.1 Channel Scan

##### 10.2.1.1.1 Antenna

Select Antenna in the Tuner Mode submenu and press the **Back** button to return to the Channel Scan menu.

Select the Satellite Auto Scan or Antenna Manual Scan submenu and press **OK**. Enter your PIN code to continue with the channel scan.

- **Antenna Auto Scan:** Press the **OK** button on the remote control to perform the automatic search for DVB-T/T2 channels.



- **Antenna Manual Scan:** Select the RF Channel by using the Right/Left directional buttons. Signal Level and Signal Quality of the selected channel will be shown. Select Start Scan and press **OK** to start the scan for the selected RF channel. The found channels will be stored in the channel list.
- **Update Scan (Antenna Auto Scan):** Press the **OK** button to turn the update scan function On/Off. When it is On, you will update the channel list information by pressing Antenna Auto Scan.

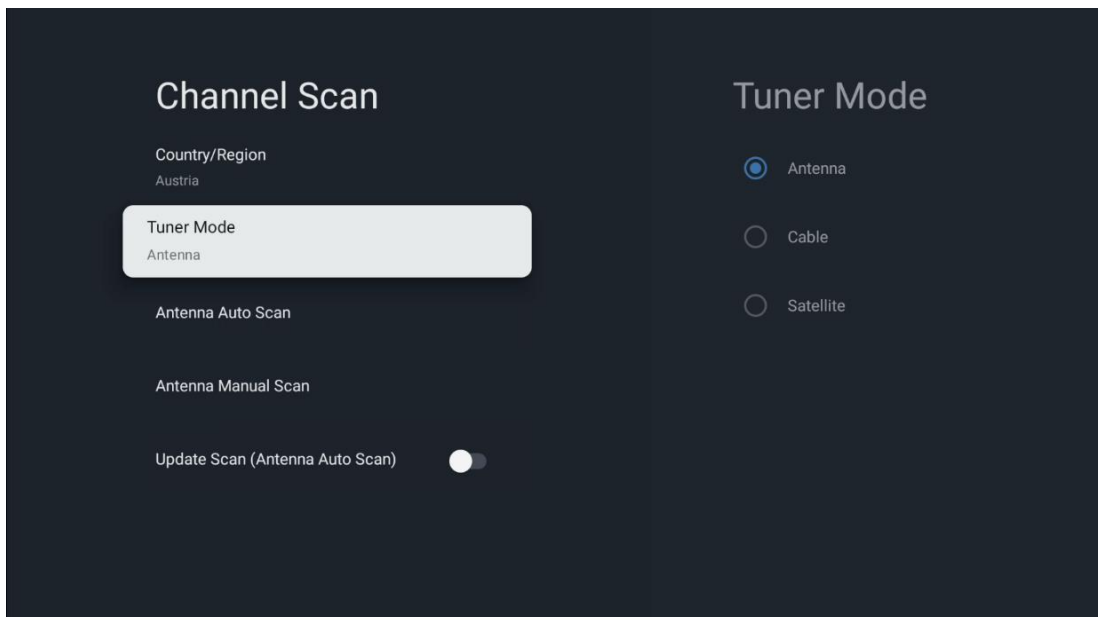

### 10.2.1.1.2 Cable

Select Cable in the Tuner Mode submenu and press the **Back** button to return to the Channel Scan menu.

Select the Cable Auto Scan or Cable Manual Scan submenu and press **OK**. Enter your PIN code to continue with the channel scan.

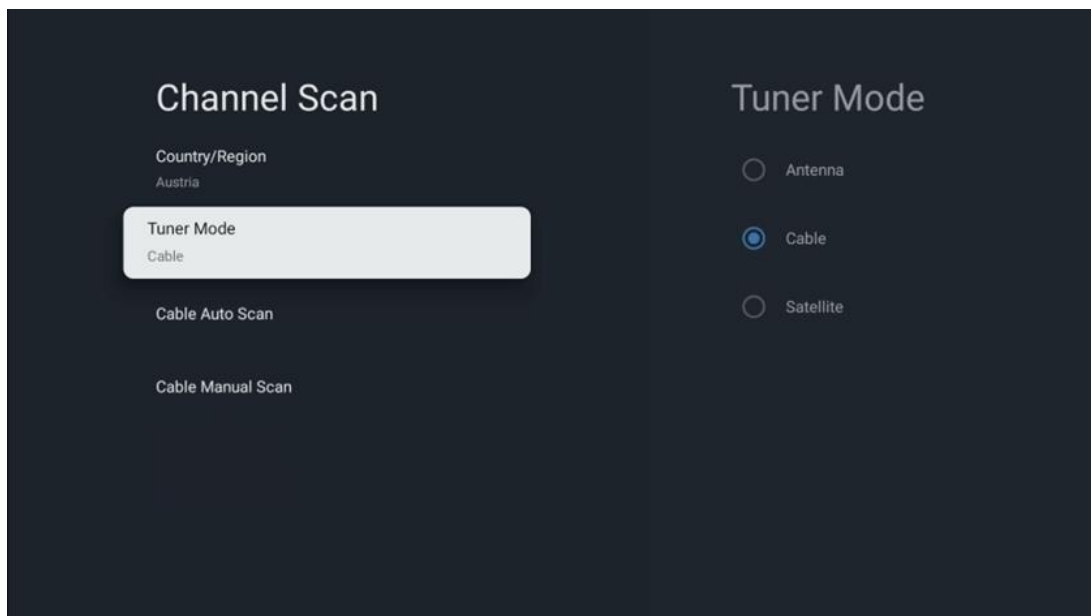

#### Cable Auto Scan

Select your Cable operator or select Others and press the **OK** button on your remote control to perform the automatic search for digital and analogue DVB-C channels.

#### Operator Scan

Optionally, DVB-C cable TV providers are listed during the initial channel installation and on the operator's list in the settings, depending on the chosen country.

#### Others

If you receive the DVB-C signal from non-dedicated cable TV providers, select the option Others. Press **OK** to start the channel search. In the Channel scan menu, you can select one of the three channel search options: Full, Advanced or Quick.

- **Full:** Automatic search of all available DVB-C channels.
- **Advanced:** Automatic search of all available DVB-C channels. For this option, it is necessary to enter the DVB-C provider's reception parameters, frequency and network ID. With this search option, the channels are sorted by LCN of the cable providers.
- **Quick:** Automatic search for all available DVB-C channels. This will search all available cable transponders with the standard symbols.

•

### Cable Manual Scan

Press the **OK** button to enter the scan settings. Press the Left/Right directional buttons to select the Channel number or Frequency on which you want to perform the manual scan of one DVB-C channel transponder.

#### 10.2.1.1.3 Satellite

#### Note for the installation of satellite channels for Thomson TVs installed in Austria or Germany:

Our Thomson TVs have a Satellite Channel Preset function, which can only be selected and executed during the initial installation of the TVs. This function is **only** available if Austria or Germany were selected as installation countries during the initial installation of the TV.

This function will **only** be performed during the initial installation of the TV when you install the satellite channels.

Select Satellite in the Tuner Mode submenu and press the **Back** button to return to the Channel Scan menu.

Select the Satellite Auto Scan submenu and press **OK**. Enter your PIN code to continue with the channel scan.

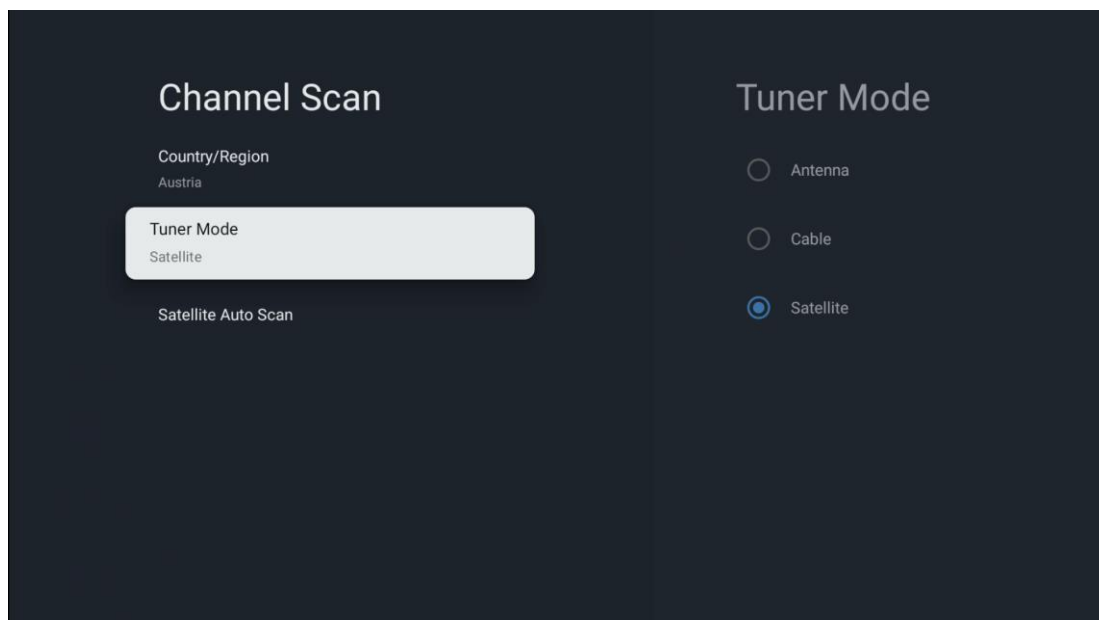

The detailed explanation for the satellite installation can be found in chapter 7.3 of this User Manual.

## 10.2.1.2 Digital Channel Setup

### 10.2.1.2.1 Subtitle Setup

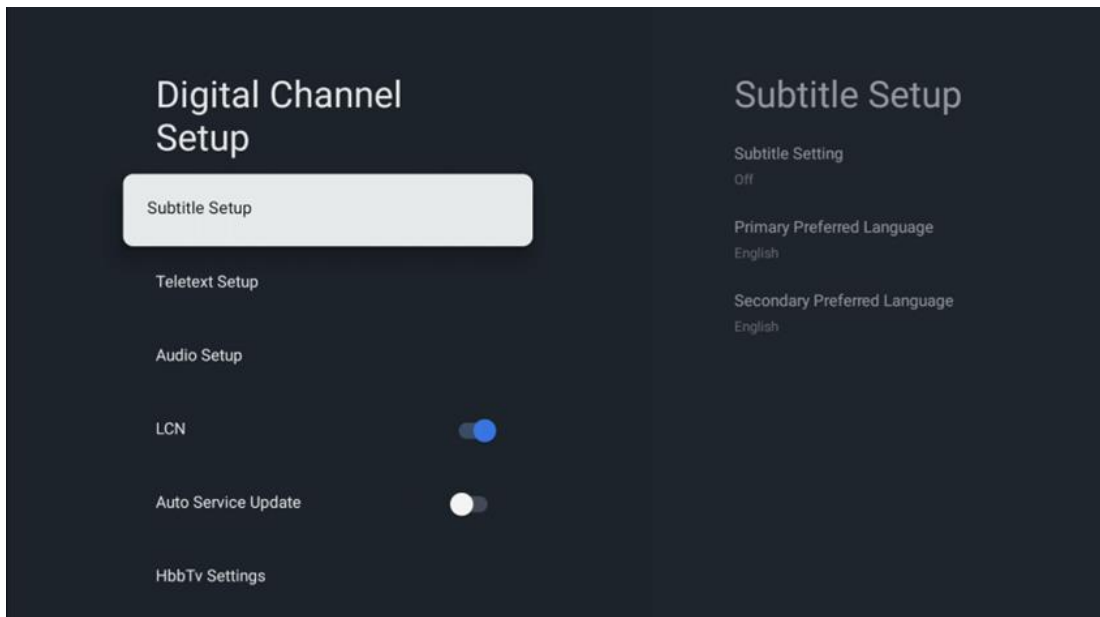

- **Subtitle Setting:** Set this option as Off, Basic or Hearing Impaired. If Hearing Impaired is selected, it provides subtitles with additional descriptions for deaf and hearing impaired viewers.
- **Primary Preferred Language:** Set one of the listed languages as the first digital subtitle language preference.
- **Secondary Preferred Language:** Set one of the listed languages as the second digital subtitle language preference. If the primary selected language in the digital subtitle language option is not available, the subtitles will be displayed using this setting.

### 10.2.1.2.2 Teletext Setup

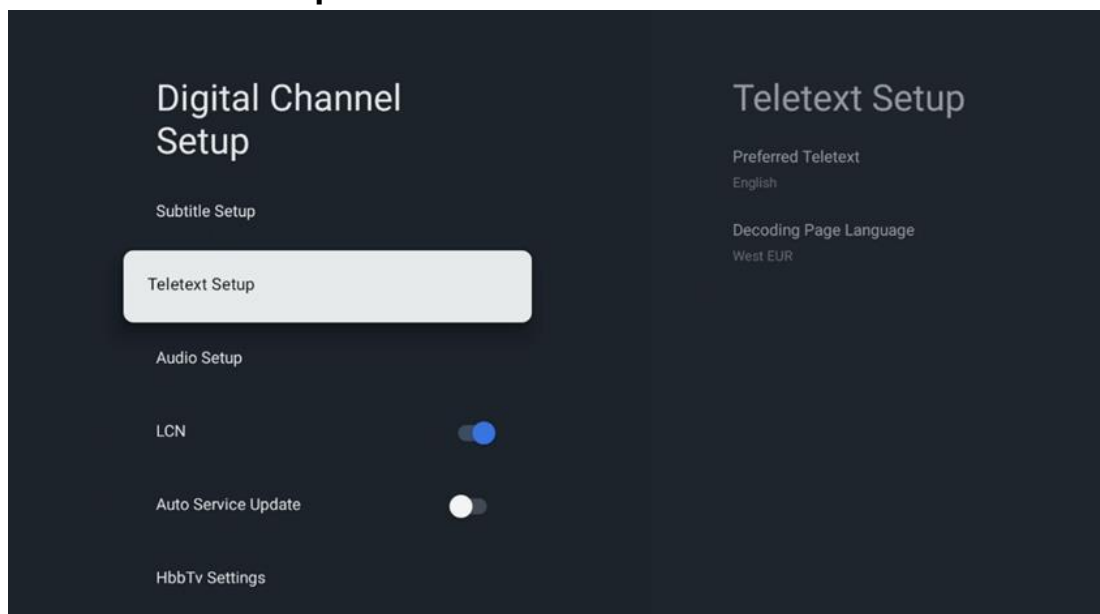

- **Preferred Teletext:** Set the teletext language for digital broadcasts.
- **Decoding Page Language:** Set the decoding page language for teletext display.

### 10.2.1.2.3 Audio Setup

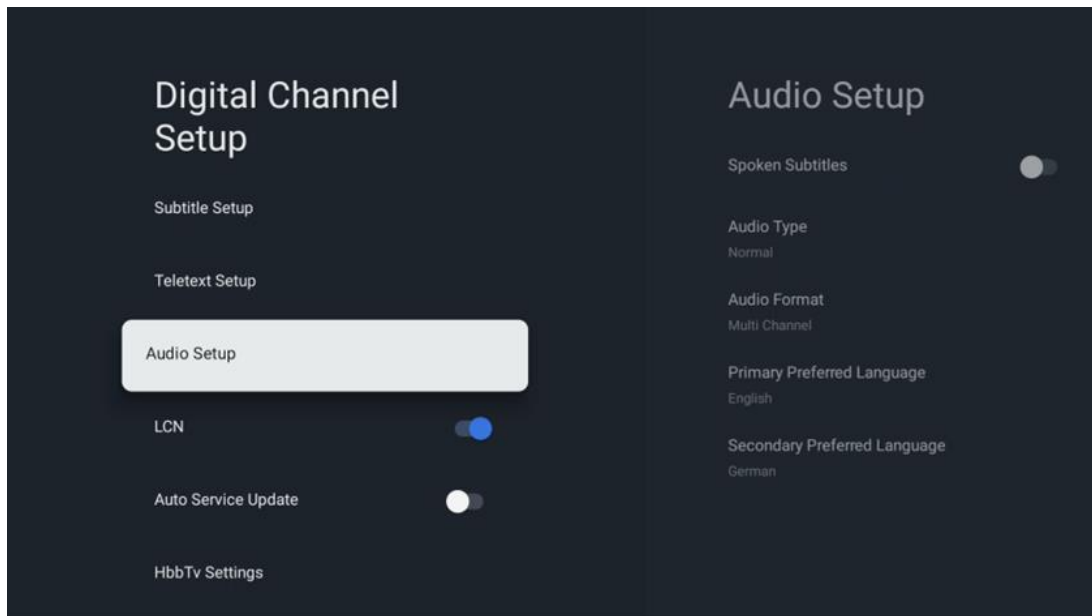

- **Spoken Subtitles:** When turned On, subtitles will also be read out loud.
- **Audio Type:** Select the option Hearing Impaired, if the TV is intended to be used by a person with hearing problems.
- **Audio Format:** Select Stereo or Multi Channel, depending on your audio system setup.
- **Primary Preferred Language:** Set one of the listed language options as your first audio language preference.
- **Secondary Preferred Language:** Set one of the listed language options as your second audio language preference. If the primary selected language in the audio language option is not available, the audio will be played using this setting.

#### 10.2.1.2.4 LCN

Logical Channel Numbering (LCN) in digital television assigns a unique number to each channel according to the provider's information.

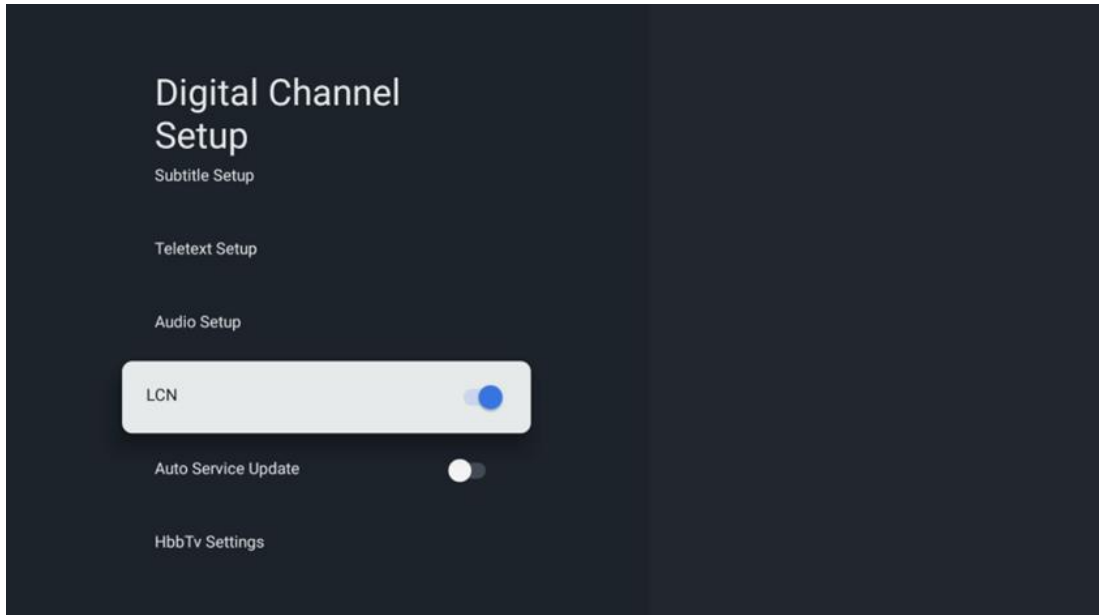

#### 10.2.1.2.5 Auto Service Update

By setting the Auto service update to On, the TV will update and add new digital channels or services automatically.

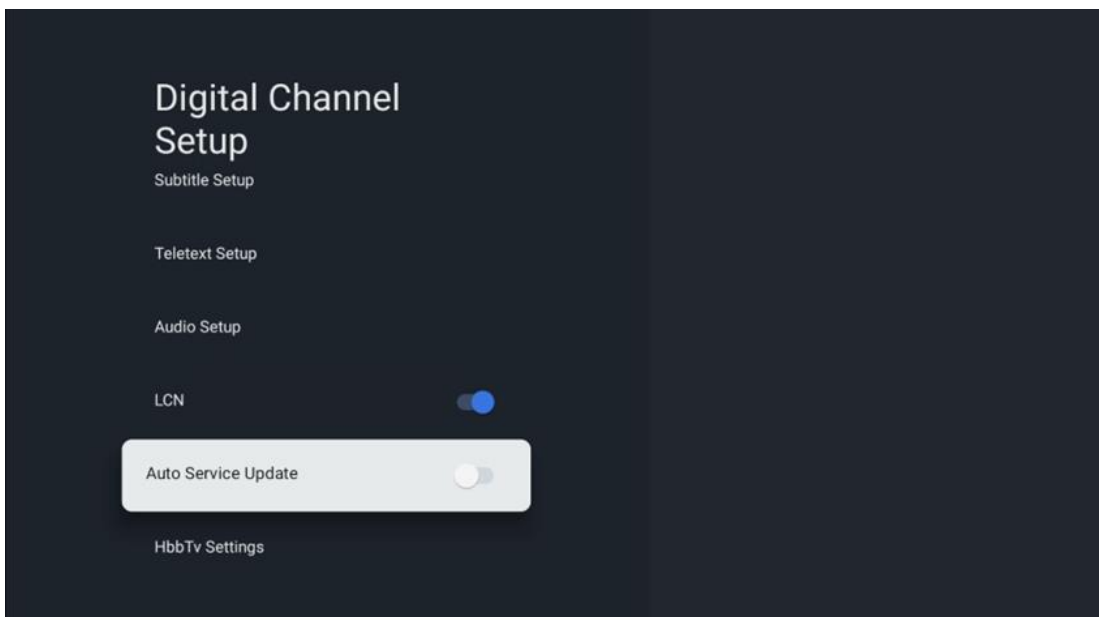

### 10.2.1.2.6 HbbTv Settings

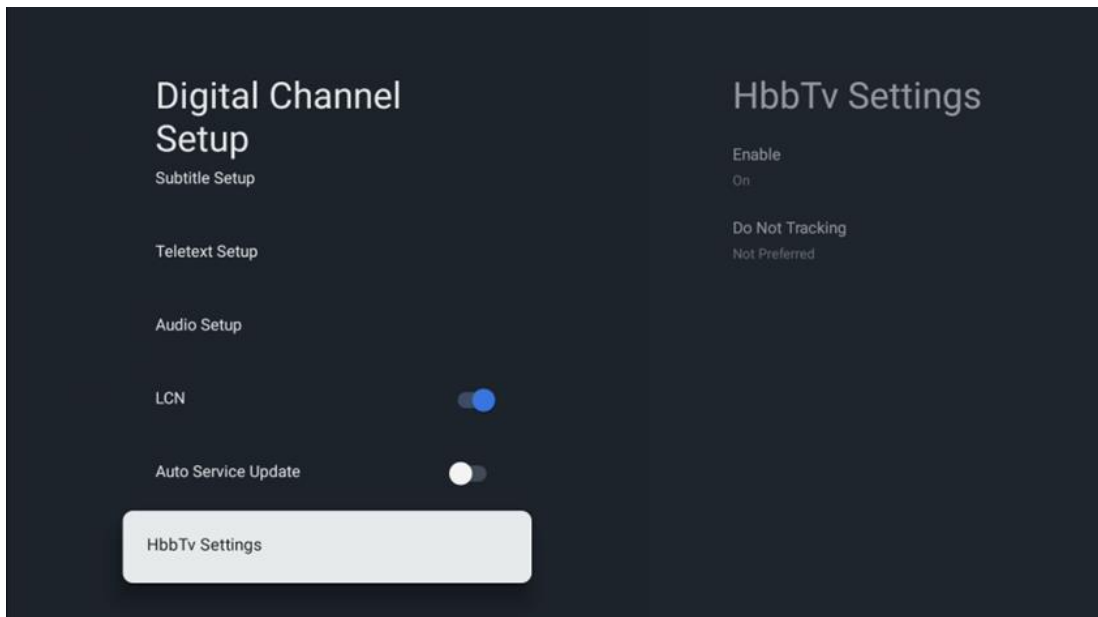

- **Enable:** Turn HbbTv On or Off.
- **Do Not Tracking:** When it is On, it disables tracking on channels with the HbbTv feature. Normally, channels track your data only for advertisement purposes.

### 10.2.1.3 Electronic Program Guide (EPG)

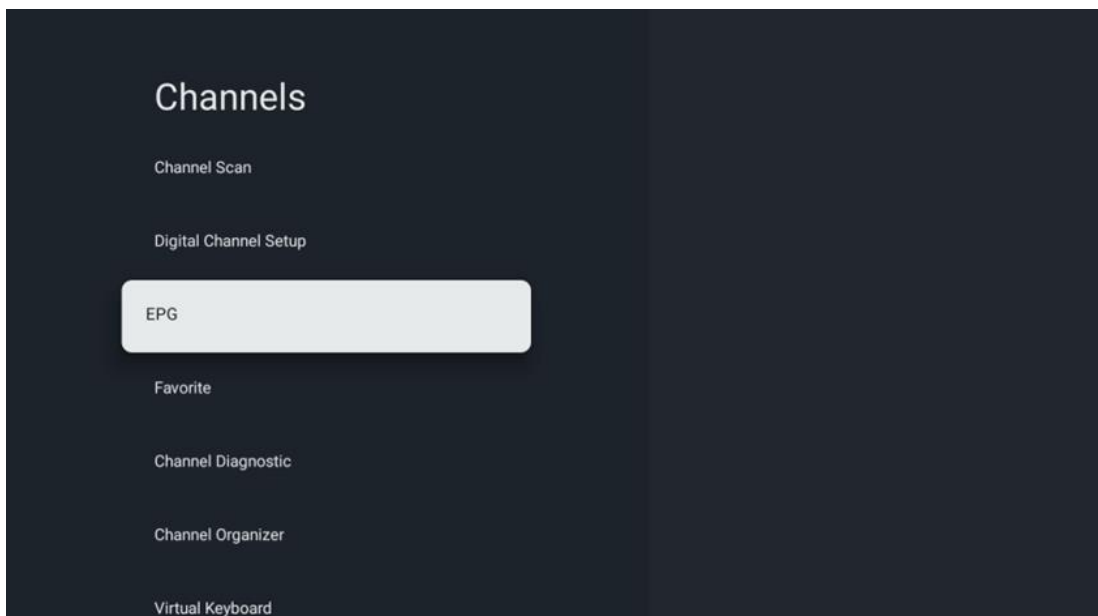

By pressing **OK** on your remote control the TV redirects you to the Live TV app and opens the EPG. Experience the convenience of the Electronic Program Guide (EPG) feature on your TV,

enabling you to effortlessly browse the schedule of channels currently available in your channel list. Please note, the availability of this function depends on the program.

Alternatively, you can access the electronic program guide while in Live TV mode, by simply pressing the **OK** button and then selecting Program guide. To return to Live TV, press the **Back** button on your remote control.

Navigate through the program guide using the directional buttons on your remote control. Utilize the Up/Down directional buttons or the Program +/- buttons to browse through channels, and the Right/Left directional buttons to select a desired event on the highlighted channel. Detailed information such as the full event name, start and end time, date, genre, and a brief description will be displayed at the bottom of the screen if available.

For more information about a highlighted event, press the **OK** button. Select View if the program is currently on air.

To view events from the previous or next day, simply press the red or green buttons respectively. To add or remove channels to/from favorites, simply press the yellow or blue buttons respectively. These functions are assigned to the colored buttons on your remote control if available. Refer to the on-screen instructions for the specific functions of each button.

Please note that the guide will not be accessible if the TV input source is locked. You can lock/unlock the input source by going to Live TV Settings > TV Options > Channel Options > Parental Controls > Source Locked.

### 10.2.1.4 Favorite

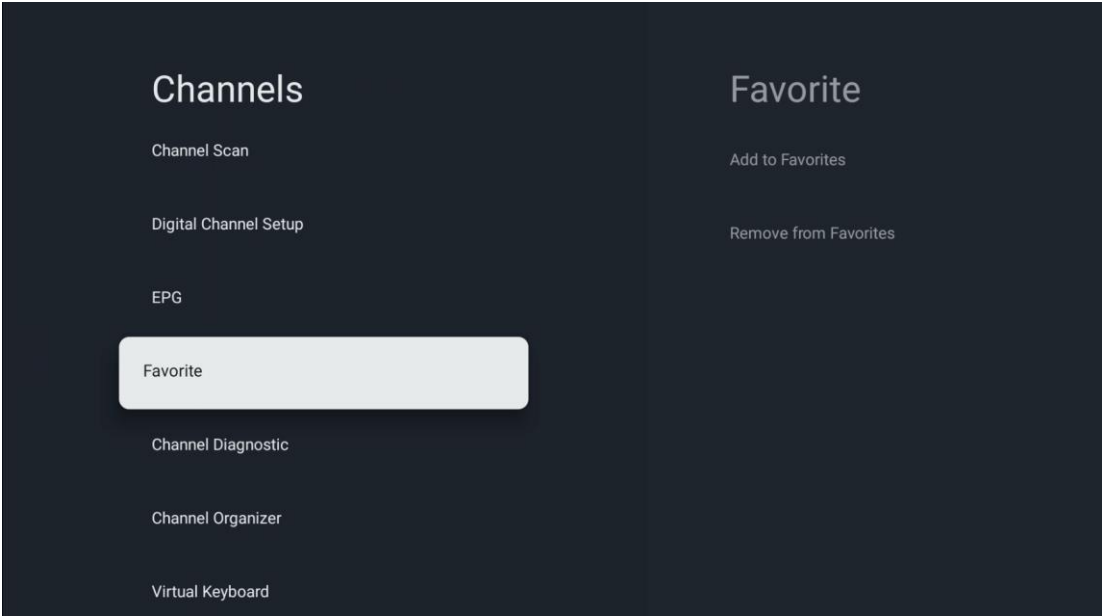



#### 10.2.1.4.1 Add to Favorites

Add your most viewed or favorite channels to your favorite list by following these steps:

- On the Home screen select the Live TV app and press **OK** to open it or press the **Live TV** button on your remote control
- Select the channel you wish to add
- Press the **Settings** button on your remote control and proceed to Channels and inputs > Channels > Favorite
- Select Add to Favorites and choose which list to add this channel to.

Alternatively, you can add channels to your favorite list in the Live TV app menu. Please, refer to chapter 11.2.2.

**Note:** You can add the same channel to multiple favorite lists.

To see your favorite lists, please refer to chapter 11.2.4.

#### 10.2.1.4.2 Remove from Favorites

Remove channels from your favorite list by following these steps:

- On the Home screen select the Live TV app and press **OK** to open it or press the **Live TV** button on your remote control
- Select the channel you wish to remove
- Press the **Settings** button on your remote control and proceed to Channels and inputs > Channels > Favorite
- Select Remove from Favorites and choose from which list to remove this channel.

Alternatively, you can remove channels from your favorite list in the Live TV app menu. Please, refer to chapter 11.2.3.

**Note:** If you have the same channel in multiple favorite lists, removing it from one list does not affect the other lists.

### 10.2.1.5 Channel Diagnostic

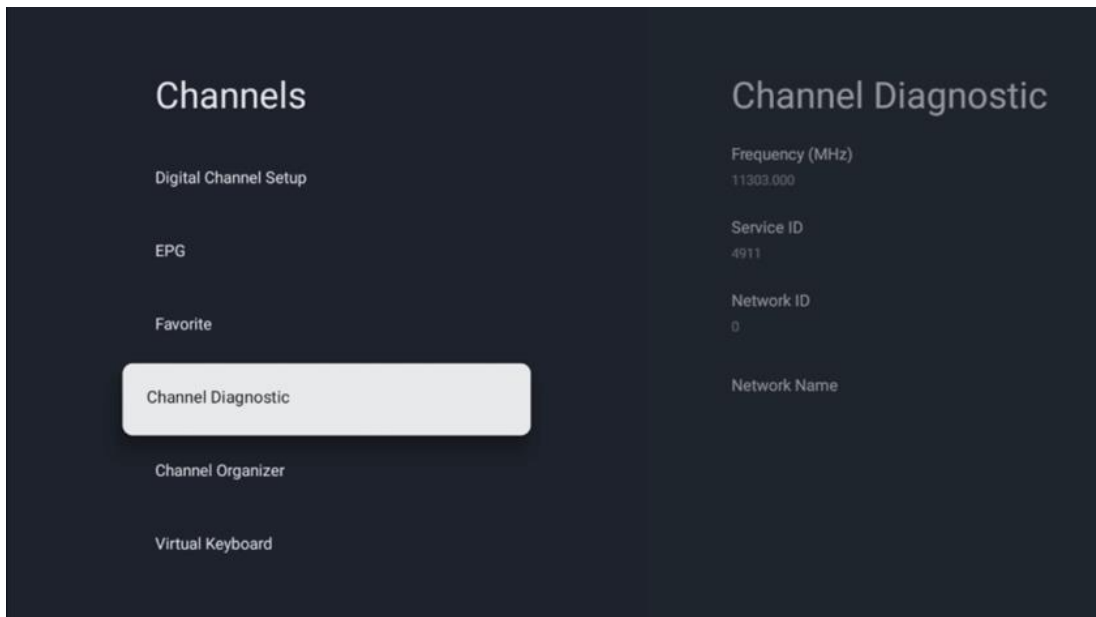

- **Frequency (MHz):** Shows the frequency of a specific channel. By pressing **OK** a pop-up window will be displayed, where the channel's frequency, its signal level and quality will be displayed.
- **Service ID:** Showcases the Service ID of a specific channel.
- **Network ID:** Showcases the Network ID of a specific channel.
- **Network Name:** Showcases the name of the network of a specific channel.

### 10.2.1.6 Channel Organizer

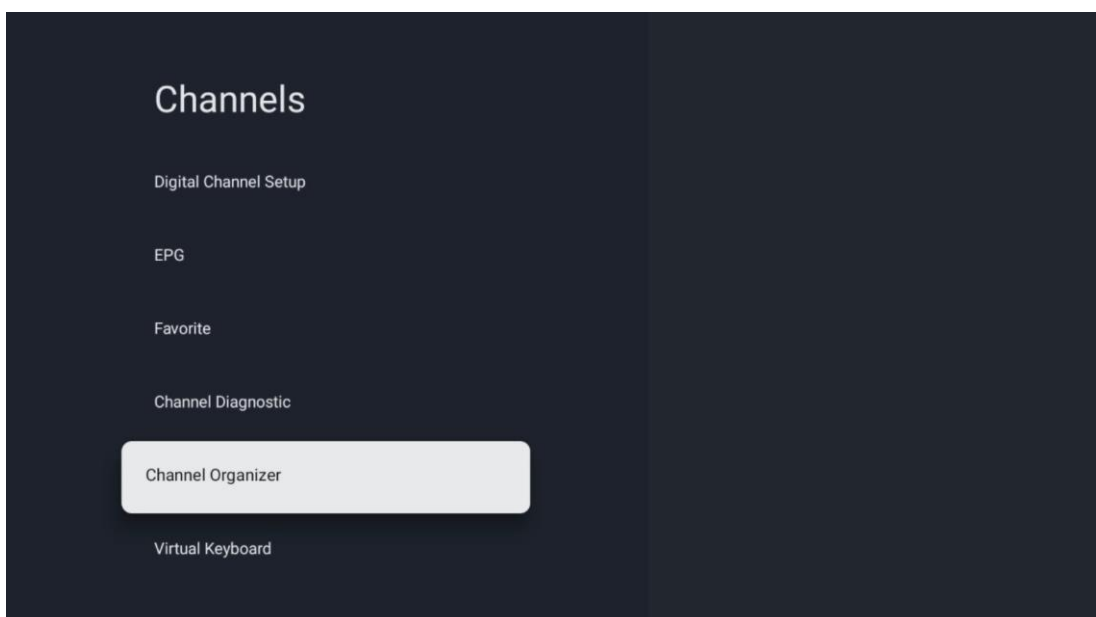

To edit the channel list, first make sure the LCN function is disabled in the Digital Channel Settings menu by following these steps. For more information about the LCN function, refer to chapter 10.2.1.2.4.

- Open Live TV app
- Press the **Settings** button
- Navigate to Channels and inputs > Channels > Digital Channel Setup > LCN. Turn LCN Off.
- Return to Channels by pressing the **Back** button
- Select Channel Organizer and press the **OK** button

Select the channel you want to make changes to and press **OK**. The following options are available:

#### 10.2.1.6.1 Channel HIDE

Hide channels from the channel list. The numbering of the channels will remain unchanged.

- Select a channel you wish to hide and press **OK**.
- Select Hide in the pop-up menu and press **OK**.
- Press **Back** to return to Live TV.

To unhide the channels follow these steps:

- Select a channel you wish to hide and press **OK**.
- Select Unhide in the pop-up menu and press **OK**.
- Press **Back** to return to Live TV.

#### 10.2.1.6.2 Channel SWAP

Switch the position of channels in the channel list.

- Select a channel and press **OK**.
- Select Swap in the pop-up menu and press **OK** to enter swapping mode.
- Select the channel you wish to change the position of and press **OK**.
- Highlight another channel you wish to swap the position with and press the Blue button.
- Press **OK** to confirm the action.

The number of swapped channels will be updated automatically according to the made changes.

#### 10.2.1.6.3 Channel EDIT

Edit channel information such as a channel's number or name.

- Select the channel you wish to edit and press **OK**.
- Select Edit in the pop-up menu and press **OK**.
- Pop-up windows with the channel number and name will show up.
- Select which information you wish to edit and press **OK**. The virtual keyboard will show up, allowing you to type in your customized information.
- Select OK and press **OK** on your remote control to confirm the changes.

- Press **Back** to return to Live TV.

**Note:** If you enter a number or name, which is occupied by another channel, an error message will show up suggesting you enter different information.

#### **10.2.1.6.4 Channel INSERT**

Move multiple channels to a different position, which results in a number change. The order of the channels remains unchanged.

- Select a channel and press **OK**.
- Select Insert in the pop-up menu and press **OK**.
- Highlight and press **OK** to select one or more channels you wish to move.
- Highlight a channel underneath which you wish to move the selected channels to and press **OK**.
- Press **OK** to confirm the action.

**Note:** The number of channels will be updated automatically according to the made changes.

#### **10.2.1.6.5 Channel DELETE**

Remove unwanted channels from the channel list. Note that to get deleted channels back, you will have to perform a channel scan.

- Select a channel and press **OK**.
- Select one or more channels you wish to delete in the pop-up menu and press **OK**.
- Press **OK** to confirm.
- A confirmation window will show up. Select Yes and press **OK**, if you want to proceed.

**Note:** The number of channels will be automatically updated according to the made changes.

#### **10.2.1.6.6 Channel MOVE**

Rearrange the position of channels in the channel list.

- Select a channel and press **OK**.
- Select Move in the pop-up menu and press **OK**.
- Select a channel you wish to move and press **OK**.
- Highlight a channel underneath which you wish to move the selected channels to and press **OK**.
- Press **OK** to confirm the action.

**Note:** The numbering of channels will be updated automatically according to the made changes.

## 10.2.2 External Inputs

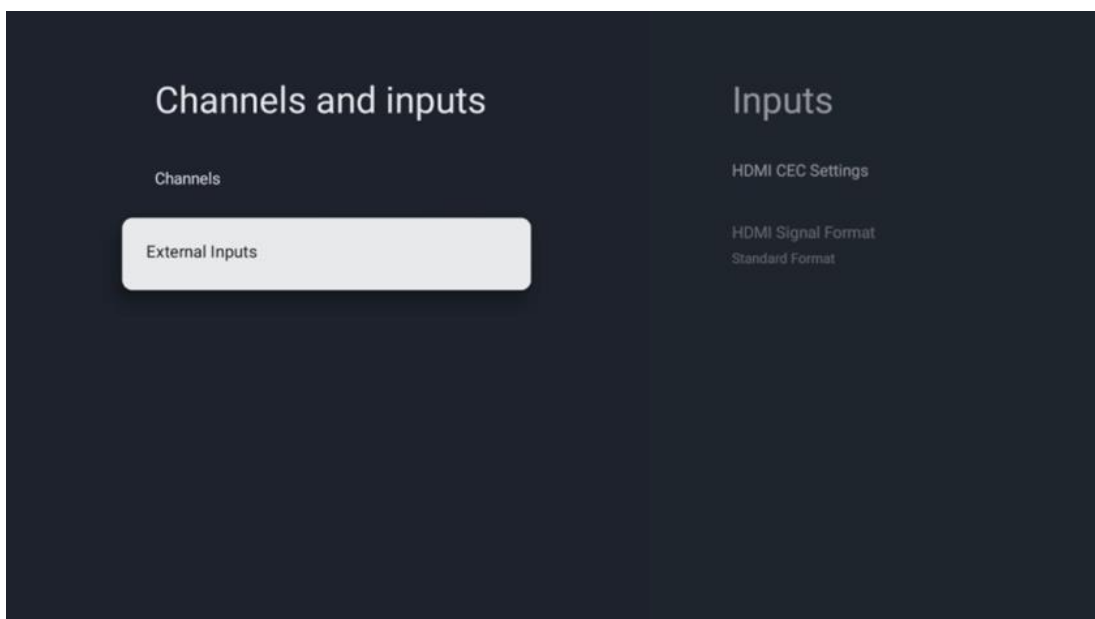

### 10.2.2.1 HDMI CEC Settings

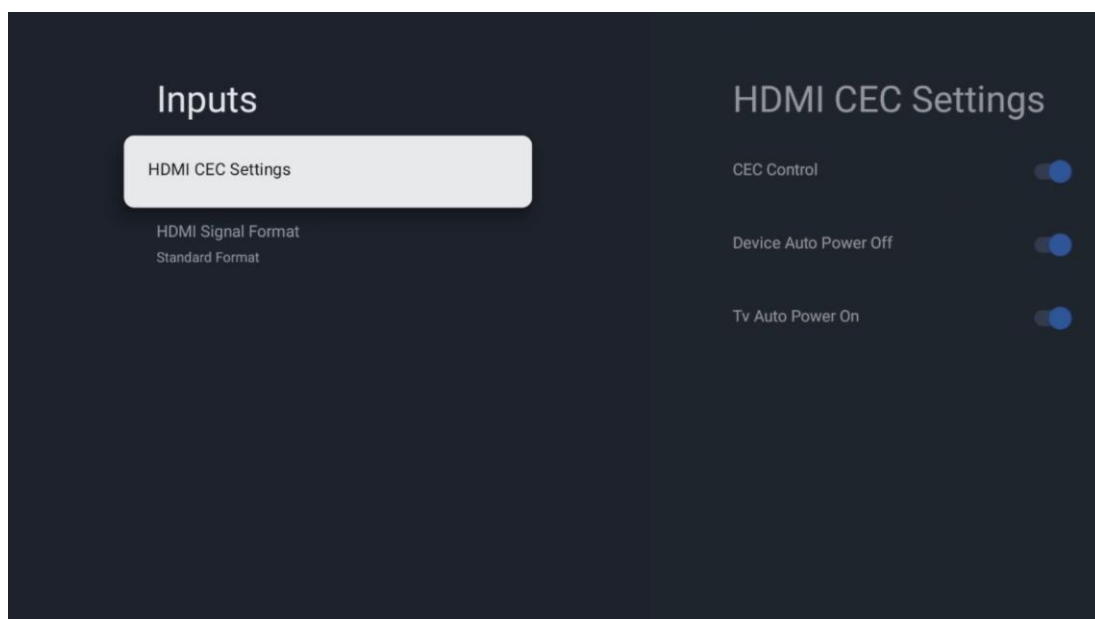

If the HDMI CEC (Consumer Electronics Control) function is activated, you can operate the external device connected to one of your HDMI connections using the TV remote control. For it to work properly, the connected external device also has to support the HDMI CEC function, it has to be activated and the operation of the HDMI CEC function of the connected external device has to be synchronised with the HDMI CEC function of the TV.

By default, the HDMI CEC function is activated and when the external device is connected, the corresponding HDMI input source will be renamed to the name of the connected device.

The TV remote control can control the external device automatically as soon as the connected HDMI source is selected.

- **CEC Control:** The TV can control HDMI devices.
- **Device Auto Power Off:** When turning off the TV, the external HDMI device will be powered off automatically.
- **TV Auto Power On:** When turning on the external HDMI device, the TV will be powered on automatically.

### 10.2.2.2 HDMI Signal Format

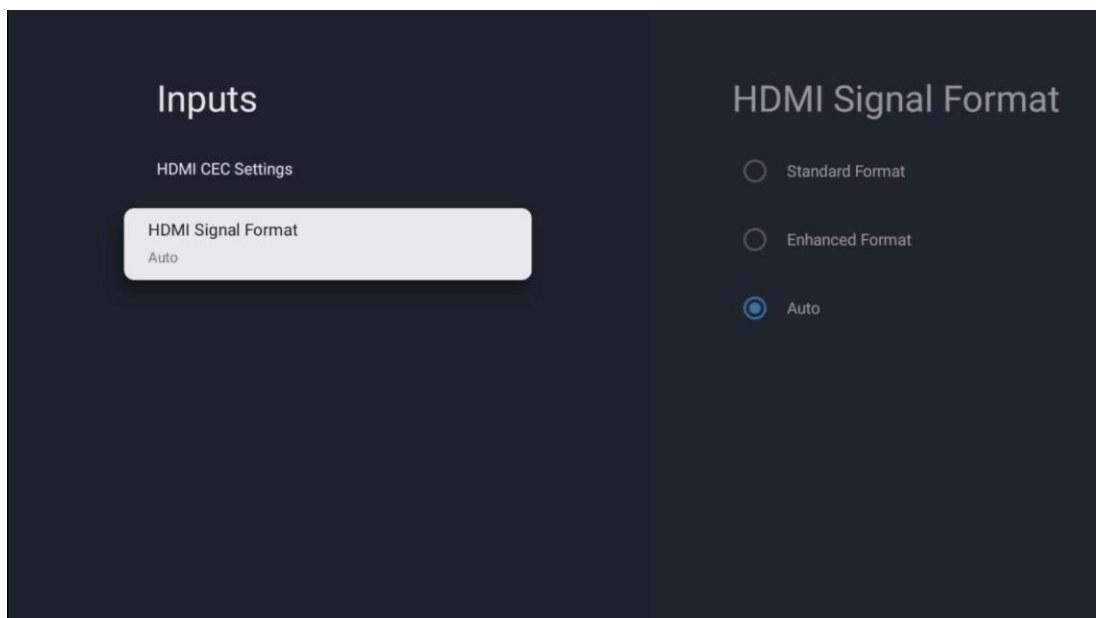

This menu is only available if the source is set to HDMI, and it allows you to choose between three available signal formats:

- **Standard Format:** If you select this format, some high resolutions may not be supported because of bandwidth limitation of HDMI 1.4 protocol.
- **Enhanced Format:** The TV will display High-Quality HDMI signals via HDMI 2.1 connection. **Note:** Your TV must have an HDMI 2.1 connection, and you might require an HDMI cable, which supports HDMI 2.1 protocol. Select this option only if your device supports High-Quality HDMI formats, such as: 4K 60Hz, 4:2:0 10 bit, 4:4:4, 4:2:2, VRR/ALLM game etc.
- **Auto:** The TV will try by default to display High-Quality signals via an HDMI 2.1 connection. **Note:** Your TV must have an HDMI 2.1 connection, and you might require an HDMI cable, which supports HDMI 2.1 protocol. If your device does not support the HDMI 2.1 format, the TV will automatically switch to the Standard Format of HDMI 1.4.

## 10.3 Display and Sound

Adjust Picture, Screen, Sound and Audio output settings. Use the directional buttons to select one of the options on the right side of the screen and confirm your choice by pressing **OK**.

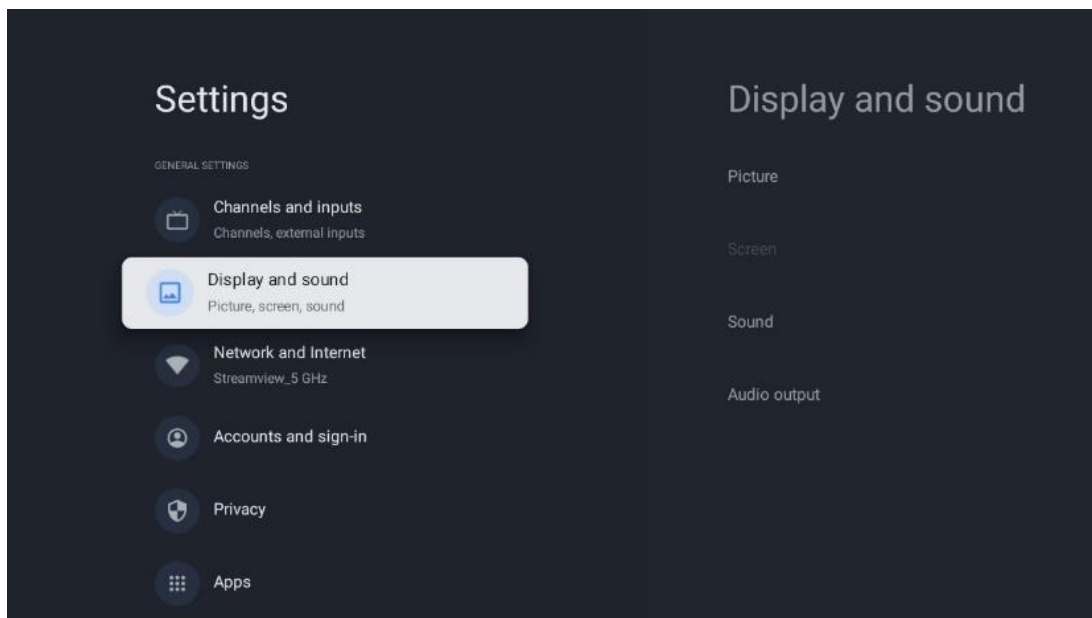

### 10.3.1 Picture

#### Picture mode

In the initial installation of the TV, by default, the TV is set to Eco picture mode. Select one of the picture mode presets and confirm your choice by pressing the **OK** button on your remote control.

#### WCG

Wide color gamut (WCG) is often paired with HDR, though they are not inherently linked. HDR increases the dynamic range, enhancing picture clarity with brighter brights and darker darks. In contrast, WCG enhances color reproduction, making reds redder, blues bluer, and greens greener. Therefore, HDR improves picture clarity quantitatively, while WCG does so qualitatively. Press **OK** to select WCG options.

- **Screen brightness:** Press **OK** to adjust the brightness of the screen.
- **Advanced settings:**
  - **Color temperature:** Set your color temperature preference. The available options are Standard, Warmer, Warm, Cool and Cooler.
  - **Dynamic contrast:** Dynamic contrast is activated by default. You can either activate or deactivate it.
  - **HDMI PC/AV mode:** This menu option is only available when a PC or game console is connected to the TV.
  - **Noise reduction:** Set your noise reduction preference as Low, Medium, High, Auto or turn it off.

- **Picture reset:** Reset the picture settings to factory default settings.
- **ALLM:** Auto Low Latency Mode (ALLM) is a function that automatically switches between low latency mode and high picture quality mode depending on the source input from an HDMI-connected device, such as a gaming device. This menu option is only available when a PC or game console is connected to the TV.
- **MEMC:** MEMC (Motion Estimation/Motion Compensation) is a technology used in TVs and video displays to reduce motion blur and judder in fast-moving scenes. Motion estimation identifies motion in successive frames, while motion compensation creates and inserts intermediate frames to smooth out the motion.

### 10.3.2 Screen

Adjust the Aspect ratio of your TV screen.

### 10.3.3 Sound

Adjust the sound settings of your TV.

- **Sound mode:** Set your sound preference as Standard, Cinema, Music, News or Personal.
- **Dolby Atmos:** Activate or deactivate Dolby Atmos. After changing this setting option, you must unplug the device briefly from the power supply and plug it back in (power reset).
- **Surround Mode:** Only available for Multimedia or Live TV playback content that includes surround sound.
- **Sound only:** Turn off the TV screen and only play audio. This setting is useful when listening to radio channels received via aerial, cable TV or satellite.
- **Advanced Settings:**
  - **Dialog Enhancer:** Automatically adjust the sound of dialogues, making them stand out from other sounds.
  - **Balance:** Adjust the left and right volume balance for speakers and headphones.
  - **Sound reset:** Reset the sound settings to factory defaults.

### 10.3.4 Audio Output

#### Output Device

- **TV speakers:** Select this option if your TV is not connected to the AV receiver via optical audio output or via HDMI cable.
- **SPDIF/Optical:** Select this audio option if your TV is connected to the AV receiver via the optical cable.
- **HDMI ARC:** Select this audio option if your TV is connected to the AV receiver via HDMI from the eARC port of your TV.

#### Audio Output Type

- **PCM (Pulse Code Modulation):** An analog audio signal is converted into a digital signal that is individually demodulated and played back by the AV receiver.



- **Passthrough:** The audio signal is forwarded to the AV receiver without TV modulation.
- **Auto:** The TV audio output is automatically configured according to the connected AV receiver.

### Digital Audio Delay (ms)

Set the delay of the audio output.

### Digital Audio Volume

Set the volume level of the audio output.

### eARC

- **Off:** Activate or deactivate the eARC function.
- **Auto:** The eARC function of the HDMI output is automatically configured according to the connected AV receiver or soundbar.

## 10.4 Network and Internet

You can configure your TV's network settings using the options of this menu.

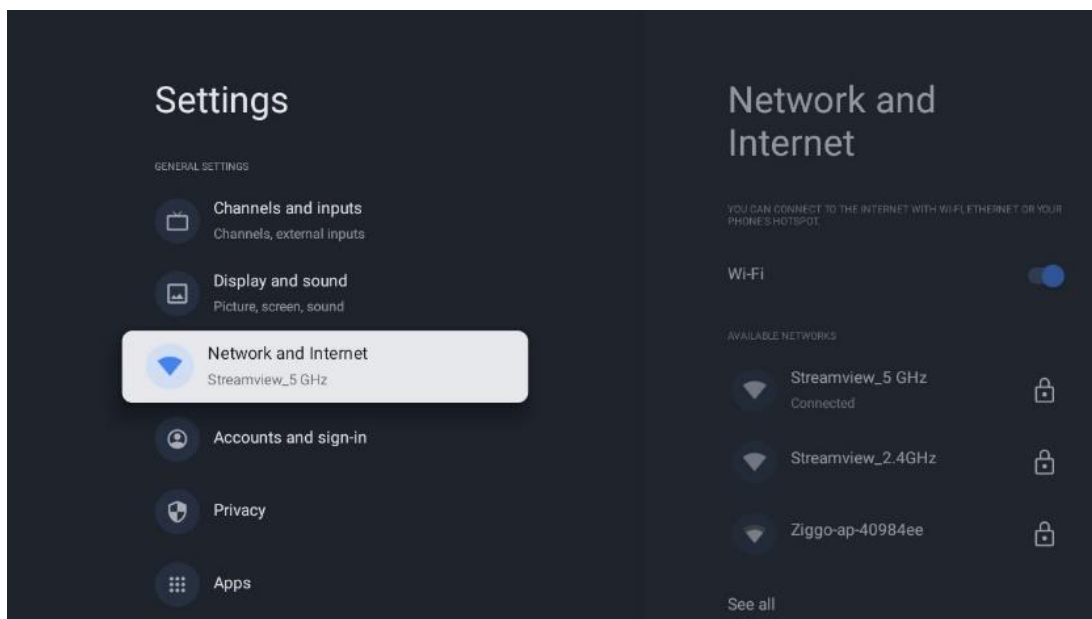

### 10.4.1 Wi-Fi On/Off

Turn the wireless LAN (WLAN) function on and off.

### 10.4.2 Choose available Wi-Fi network

When the Wi-Fi function is turned on, available wireless networks will be listed. Highlight See all and press **OK** to see all networks. Select one and press **OK** to connect. You may be asked to enter a password to connect to the selected network in case the network is password protected.

### 10.4.3 Other options

- **Add new network:** Add networks with hidden SSID's.
- **Scanning always available:** You can let the location service and other apps scan for networks, even when the Wi-Fi function is turned off. Press **OK** to turn it on and off.

### 10.4.4 Ethernet options

- **Connected / Not connected:** Displays the status of the internet connection via Ethernet, IP and MAC addresses.
- **Proxy settings:** Set a HTTP proxy for browser manually. This proxy may not be used by other apps.
- **IP settings:** Configure your TV's IP settings.

## 10.5 Accounts and sign-in

- **Google TV account:** This option will be available if you have signed in to your Google account. You can lock your account preferences, configure your data syncing preferences, manage your payments and purchases, adjust Google Assistant settings, enable Apps-only mode, and remove the account from your TV.
- **Add account:** Add a new account by signing in to it.
- **Add a child:** Add a child-friendly account with parental protection.

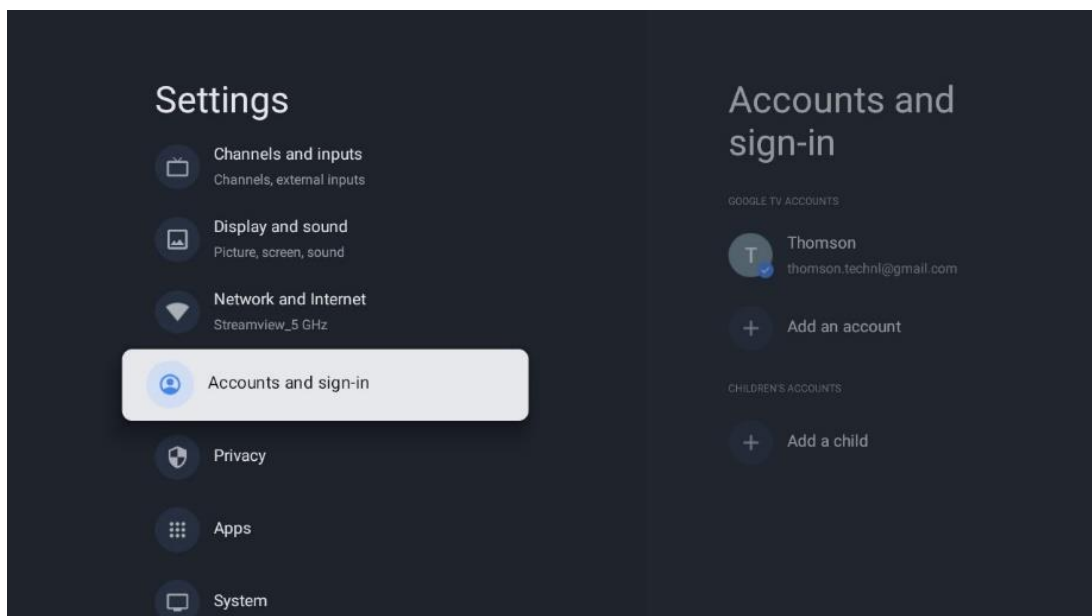

## 10.6 Privacy

Change and adjust your privacy settings and app permissions.

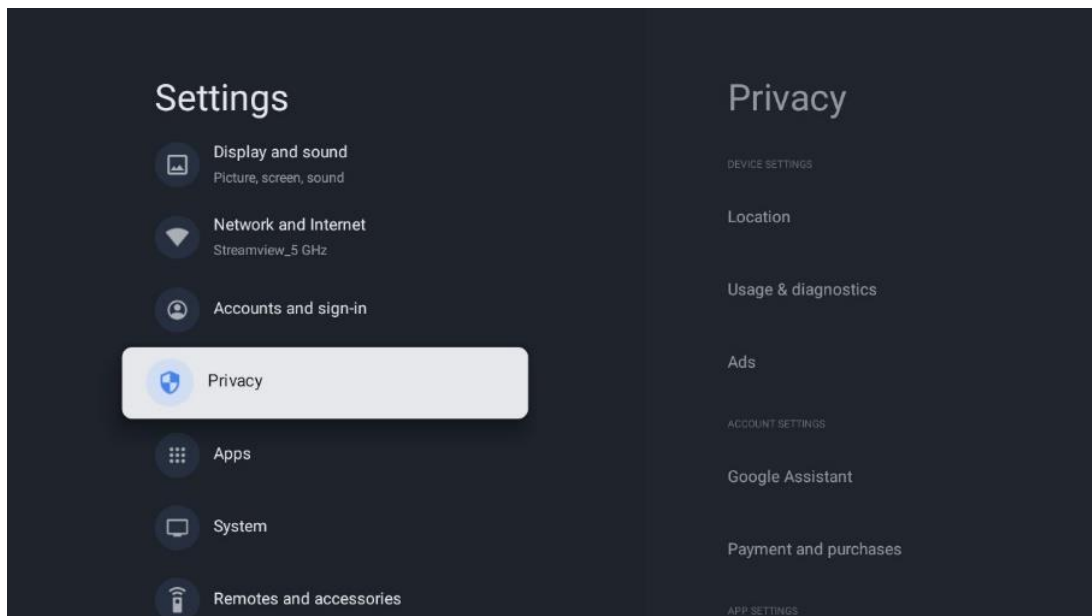

### Device settings:

- **Location:** Select whether Google may collect location data according to your Wi-Fi. It is important that you provide Google with your location because the installation of many applications depends on the Geo-location. Installation of certain streaming applications, especially those that stream TV broadcast channels, is only possible according to Geo-location rules.
- **Usage & diagnostic:** Automatically send diagnostic information to Google.
- **Ads:** Select whether Google is allowed to collect usage data and diagnostics and promote personalized ads to you.

### Account settings:

- **Google Assistant:** Select your active account, view permissions, select which applications should be included in the search results, activate the secure search filter and view the open-source licences.
- **Payment and purchases:** Setup Google Payment and Purchase settings.

### App settings:

- **Special app access:** Select which apps can have access to your information and have special access.
- **Security and restrictions:** You can use the options in this menu to allow or restrict the installation of apps from sources other than the Google Play Store. Set the options so that your TV does not allow or warns against the installation of apps that could cause serious issues.

## 10.7 Apps

Use the options in this Menu to manage the applications installed on your TV.

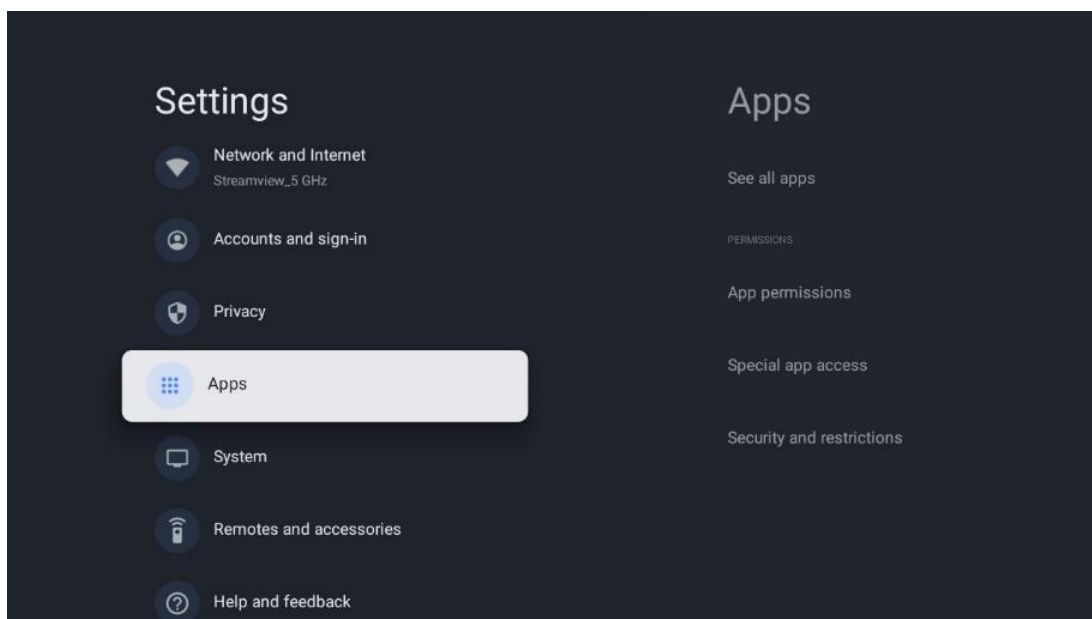

**Recently opened apps:** Recently opened apps are displayed here.

**See all apps:** Select See all apps and press **OK** to display a comprehensive list of all installed apps on your TV. You will also be able to see the storage space each App occupies. From there you can check App versions, start or force stop their operation, uninstall downloaded Apps, check permissions and switch them on or off, manage notifications, clear data and cache and much more. Simply highlight an App and press **OK** to access the available options.

**Permissions:** Manage the permissions and some other features of the apps.

- **App permissions:** The apps will be sorted by permission type category. You can enable/disable permissions for apps from within these categories.
- **Special app access:** Configure app features and special permissions.
- **Security & restrictions:** Using the options of this menu, you can allow or restrict installation of apps from sources other than the Google Play Store. Set the TV to disallow or warn before installation of apps that may cause harm.

## 10.8 System

Use the directional buttons to view the options About, Date & Time, Language, Storage, Power and energy and others. Press **OK** to select the corresponding sub-option you want to adjust.

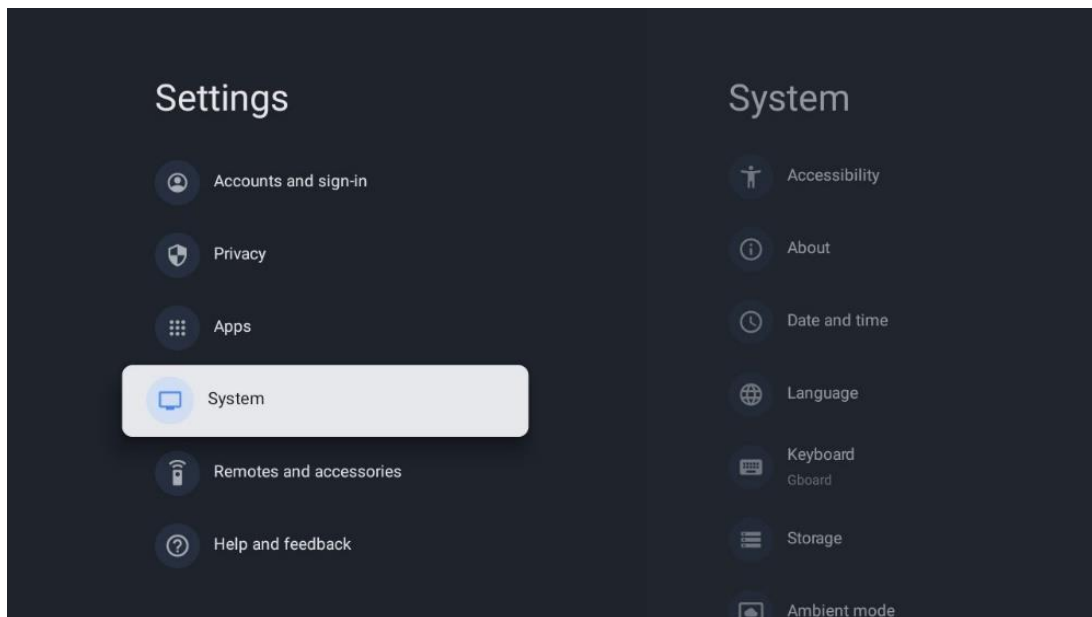

### 10.8.1 Accessibility

- **Captions:** Turn on/off captions, adjust their language and text size and choose a caption style.
- **High-contrast text:** Enable or disable high-contrast text.
- **Text to speech:** Enable or disable Google’s text to speech function. This function will automatically voice text displayed on your screen. It is a useful function for people with eyesight problems. In this menu section you can adjust settings for Text to speech such as speech rate and default language.
- **Accessibility shortcut:** Enable or disable.
- **Talk back:** Enable or disable talk back and customize it.
- **Switch access:** Enable or disable switch access and customize it.

### 10.8.2 About

Here you can find hardware and software information about your TV as well as the Android OS and the Netflix ESN version.

- **System update:** Select this Menu option and press **OK** on your remote control to check if a software update is available for your TV.
- **Device name:** Select this Menu option and press **OK** on your remote control to change the name or assign a customised name for your TV. This is important because your TV should be correctly identified in your network or when performing the Chromecast function.
- **Reset:** Select this Menu option to reset your TV to factory settings and reinstall your TV.
- **Status:** In this Menu you will find the hardware information of your TV such as IP address, MAC address, Bluetooth address, Serial number and Uptime.
- **Legal information:** In this menu you will find the Legal information of your TV.

- **Model:** Shows you the model of your TV.
- **Android TV OS version:** Shows you which OS version is installed on your TV.
- **Android TV OS security patch level:** Shows the date of the security patch installed on your TV.

### 10.8.3 Date and Time

Set the date and time on your TV. You can have this data be updated automatically via network or via broadcasts. Set them according to your environment and preferences. Deactivate the Automatic date & Time option if you want to change the date or time manually. Then set the date, time, time zone and hour format options.

### 10.8.4 Language

Set the Menu language of your TV.

### 10.8.5 Keyboard

Select your virtual keyboard type and manage keyboard settings.

### 10.8.6 Storage

The total storage space status of the TV and the connected devices, if available, is displayed here. To view detailed usage information, highlight Internal storage partition or External storage connected device and press **OK**. Options for ejecting and formatting the connected storage devices are also displayed.

### 10.8.7 Ambient Mode

Ambient mode on a TV is a feature that transforms the TV screen into a digital photo frame or virtual art display when not in use. You can manually start this mode in this menu section.

- **Channels:** Choose the source of photos or images to show in ambient mode.
- **More settings:**
  - Display the weather in C or F. You may choose to show both degree systems or hide degrees at all.
  - Display or hide time.
  - Adjust personal photos and Google Photos settings.
  - Portrait Google Photos.
  - Personal Photo curation.
  - Adjust slideshow speed.

### 10.8.8 Power and Energy

- **Power-on behavior:** Choose whether you want to see the Google TV home screen or the last used input source after your TV has turned on.

- **Energy saver:** Adjust the time of inactivity, after which the TV turns itself off automatically.

### 10.8.9 Cast

When running the Chromecast function from the mobile device that is in the same network as your TV, your TV will be recognized as a Google Cast device and allows the Google Assistant and other services to wake up your TV and respond to connected Chromecast devices. It will be possible to stream content or local multimedia content from your mobile devices to your TV.

Select your preference for Chromecast availability. You have three setting options:

- **Always:** your TV will always be visible to other devices that support this feature (even if it is in standby mode and the screen is switched off).
- **While casting:** Your TV will only be visible while using the Chromecast function.
- **Never:** Your TV will not be visible to other devices.

### 10.8.10 Google

Check whether there are any system service updates available.

### 10.8.11 System sounds

Activate or deactivate the system sounds.

### 10.8.12 Television

- **Sleep timer:** Set a time after which the TV should switch off automatically.
- **Idle TV Standby:** Set a time after which the TV should switch off automatically when inactive.
- **Setting Exit Timer:** Set a time after which the TV should automatically go to the Home screen or TV/HDMI mode when inactive.
- **Settings:**
  - **Lock:** Set Parental Controls options such as: Enabled / Disabled, Input source block, channels which should be blocked, ratings and modification of the PIN Code.
  - **Power:**
    - **Wake on Network:** Enabled/Disabled.
    - **WoW:** Turn the Wake on WLAN function on or off. This function allows you to turn on or awaken your TV via wireless network.
    - **WoL:** Turn the Wake on LAN function on or off. This function allows you to turn on or awaken your TV via network.
    - **Wake on Chromecast:** Enabled/Disabled. The TV will be switched on or off by launching or stopping Chromecast multimedia content streaming from connected mobile device.

- **Network Standby:** In network standby mode, the standby mode of your TV can be controlled via Special apps or other network services. Activating this function causes more power consumption.
  - **USB ADB:** Enable or disable USB debugging mode.
- **Software update:** The software update of the TV will be automatically performed by Google over the Air. Please do not modify this menu option.
- **Terms and conditions:** View the terms and conditions.
- **Environment:** Choose between Home or Shop mode.
- **RCU Firmware update:** The software update of the remote control will be automatically performed by Google over the Air. Please do not modify this menu option.

### 10.8.13 System running time

The entire operating time of the TV is displayed.

### 10.8.14 Restart

Restart your TV.

## 10.9 Remote and Accessories

Connect your Bluetooth devices such as a soundbar, headphones, Bluetooth speakers, mouse & keyboard, or a game controller to your TV.

- Set the device you want to connect to pairing mode.
- Select the Pair accessory Menu option and press the **OK** button on the remote control to start the search for Bluetooth devices in pairing mode.
- The available devices will be recognized and displayed in a list.
- Select the desired device from the list and press **OK** to start the pairing process with the TV.
- When the pairing process is completed, Bluetooth connected devices will be listed under accessories.



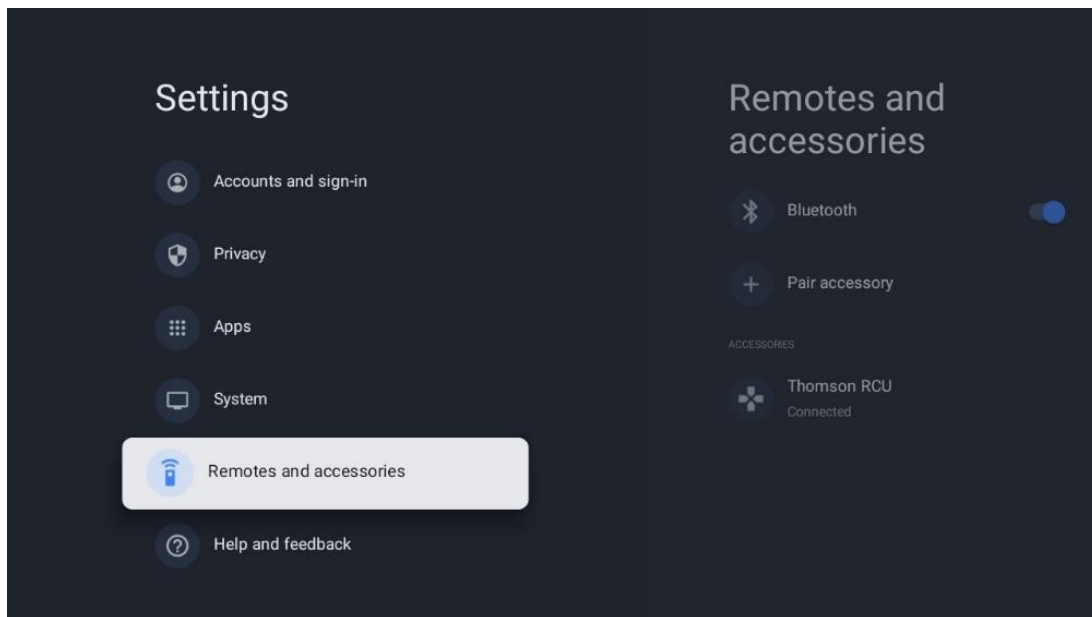

## 10.10 Help and feedback

Do you have any questions or want to leave some feedback regarding Google TV? Visit Google TV Help at [g.co/tv/help](https://g.co/tv/help).

## 11 Live TV

Select the Live TV application on the Home screen and press **OK** to start it.

When you start Live TV for the first time after installing the TV, you will be guided through several dialog screens. These screens will inform you that you can watch Live TV channels through streaming applications in addition to using the TV tuner installed on your TV.

You will also be prompted to create a four-digit PIN code. This PIN code is required to configure settings in the Parental Control menu. Additionally, the same PIN code will be necessary to view TV programs protected by Parental Control, if this option is enabled or when re-scanning for channels.

Press **OK** in Live TV mode to display the Menu options.

# 11.1 Channels Menu

## 11.1.1 Program Guide

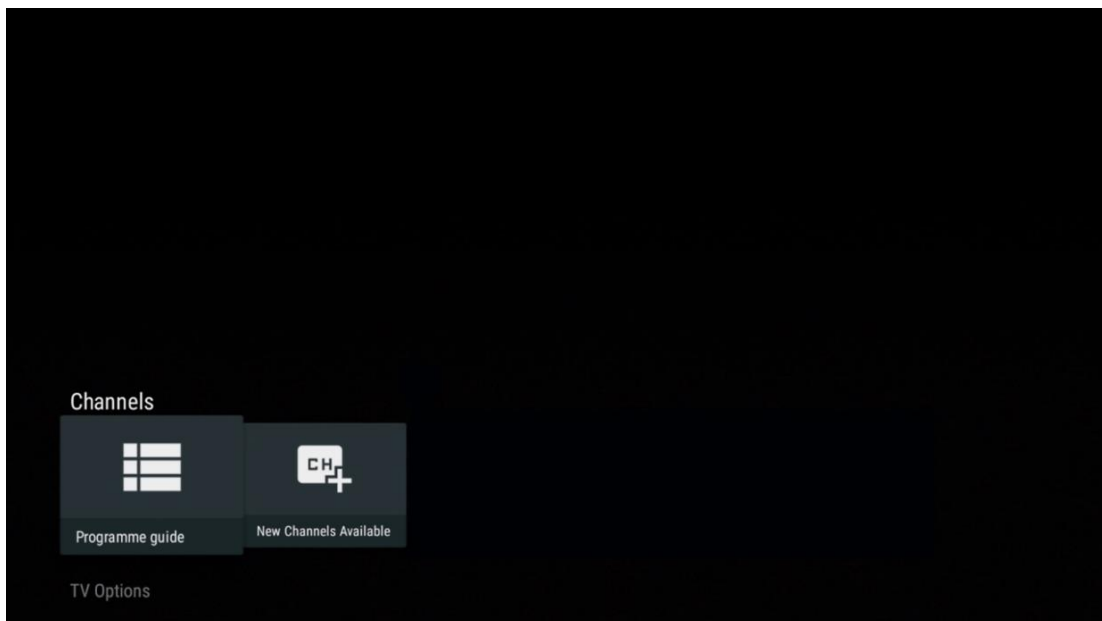

Experience the convenience of the Electronic Programme Guide (EPG) feature on your TV, enabling you to effortlessly browse the schedule of channels currently available in your channel list. Please note, the availability of this function depends on the programme.

To access the electronic programme guide while in Live TV mode, simply select the corresponding menu option or press the **EPG** button on your remote control. To return to Live TV, press the **Back** button on your remote control.

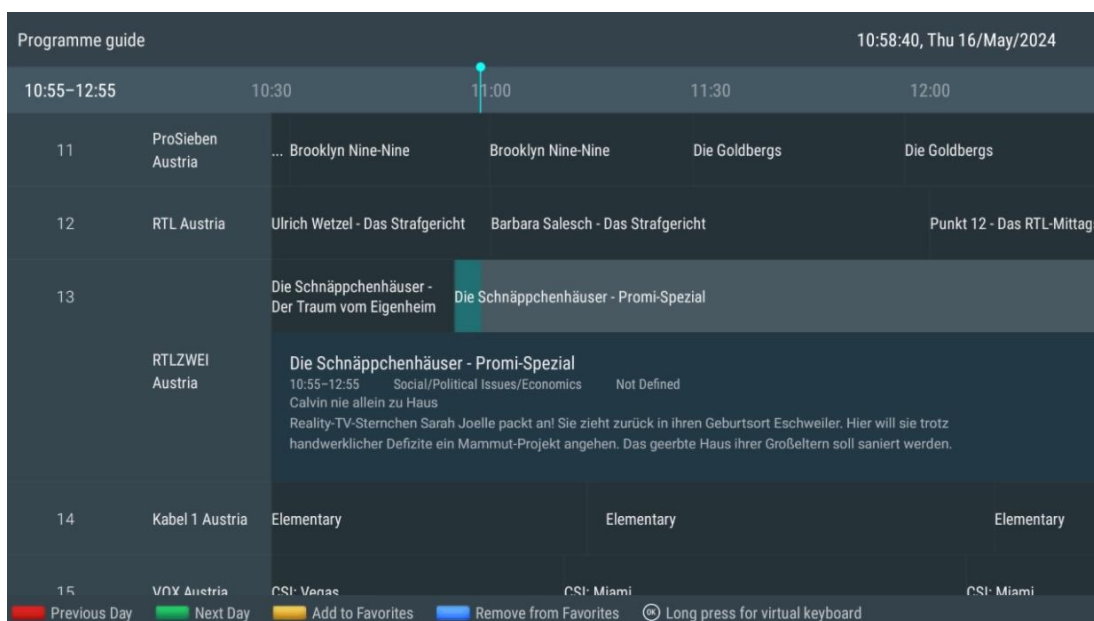

Select a current or upcoming broadcast event and press **OK** to read the content description (if available for the selected programme).

On the right side of the screen, you can see View or Reminder selection boxes.

- **View:** Select this box and press **OK** to view the current programme.
- **Reminder:** Select this box to set a reminder to watch this programme. This reminder will be displayed on the TV screen before the selected programme starts.

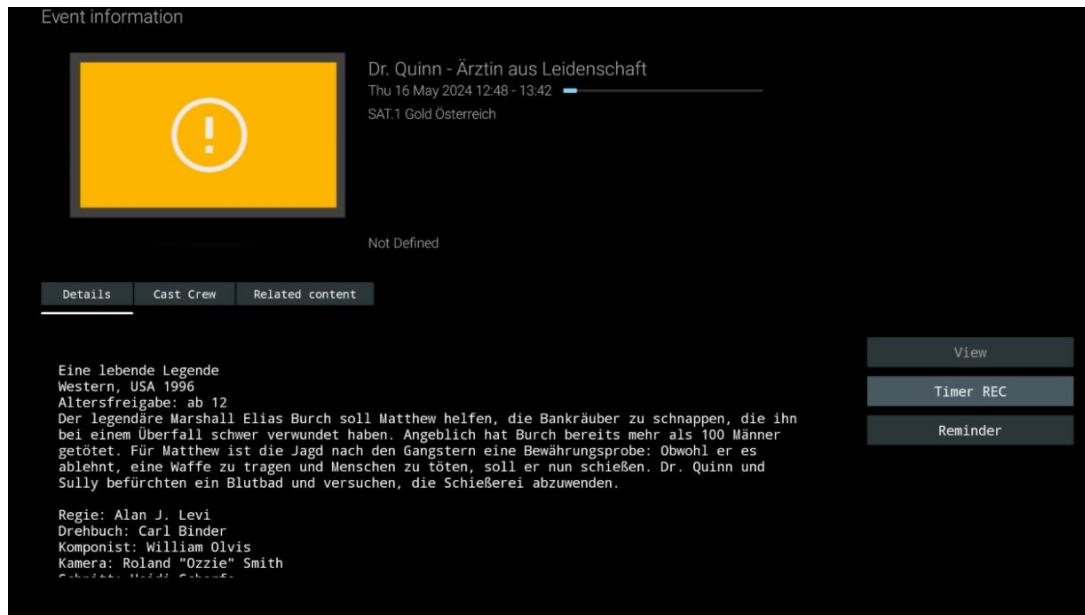

## 11.1.2 New Channels available

Select one of the Live TV broadcast sources or one of the Live TV applications to start or finish the installation.

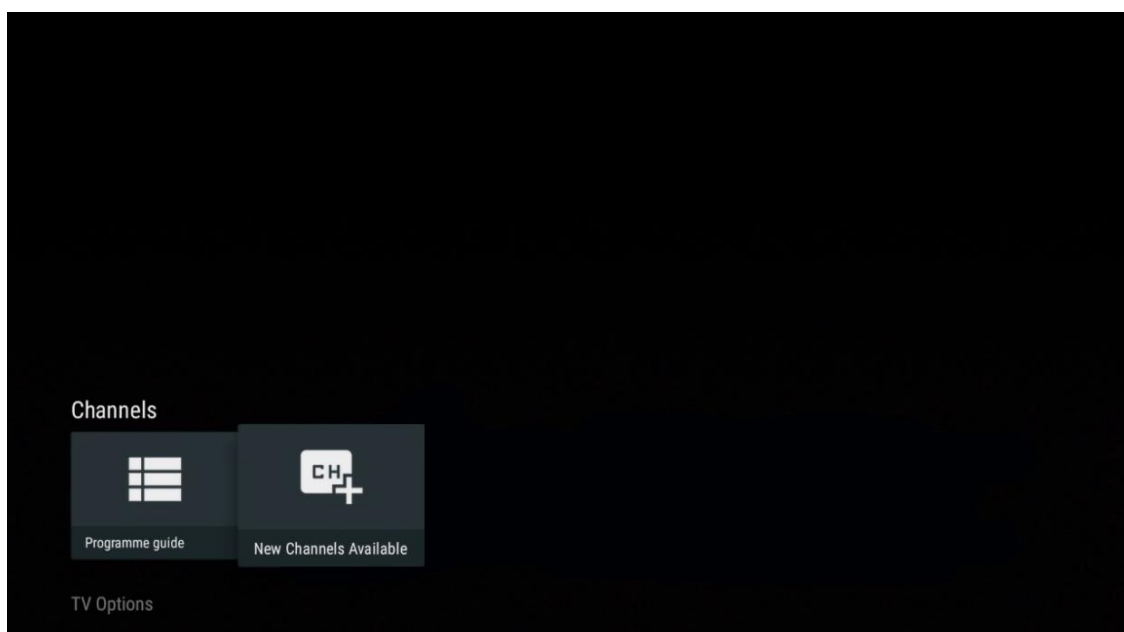

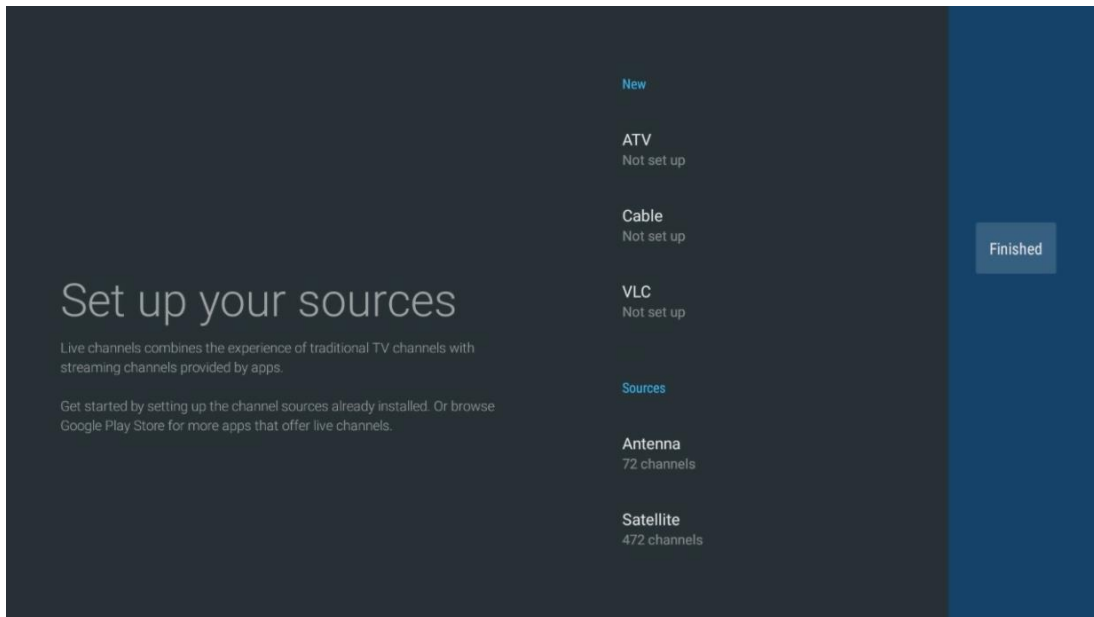

## 11.2 TV Options

To view the TV Options, press **OK** in Live TV mode and use the directional buttons to scroll to the TV Options menu.

### 11.2.1 Subtitle Language

View the available subtitle options of the current TV program. Select your preferred option and confirm your choice with the **OK** button.

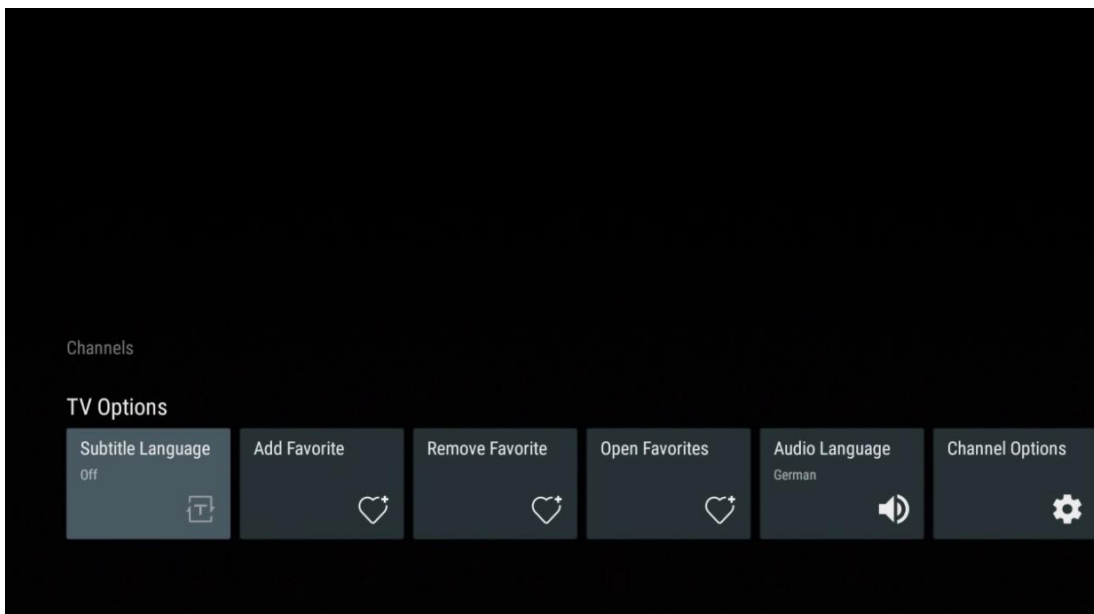

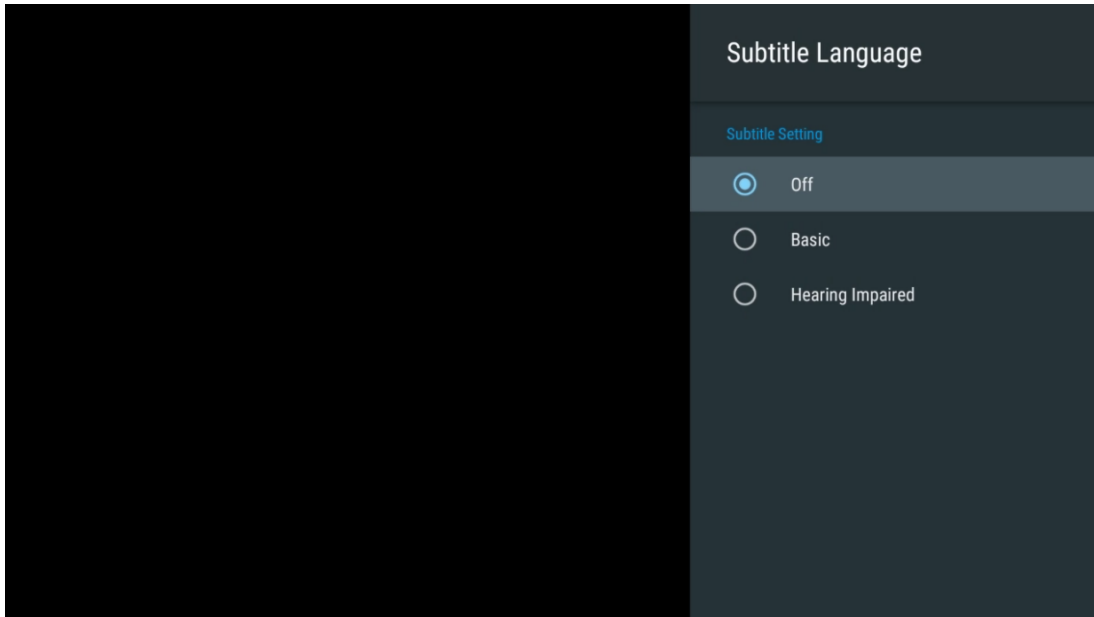

### 11.2.2 Add Favorite

Create favorite lists and add your preferred channels to it.

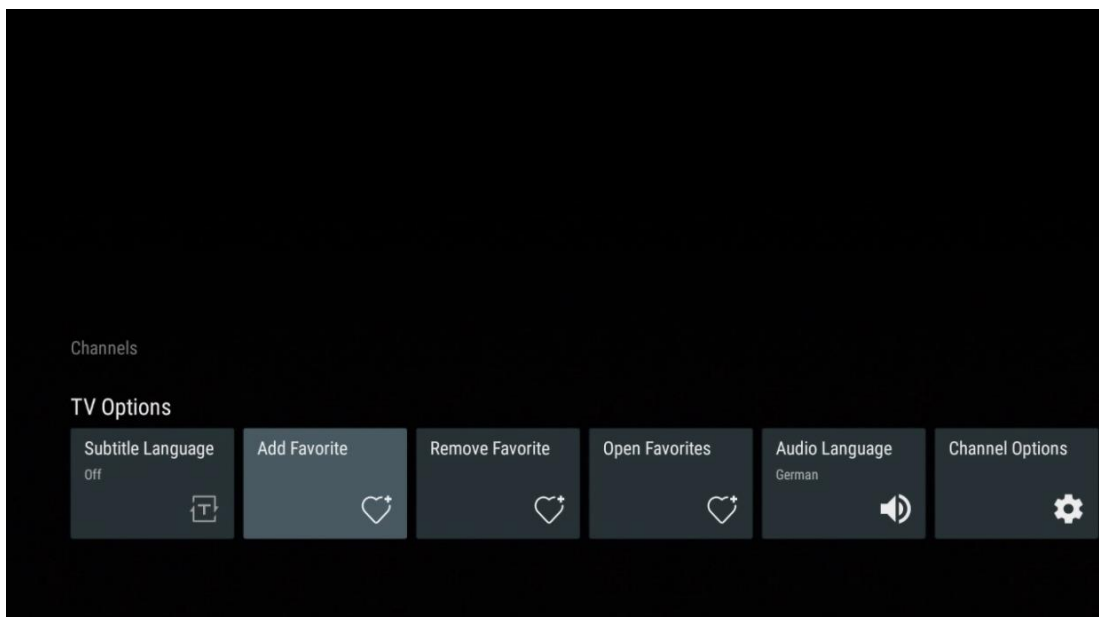

**Note:** You only have four favorite lists available. Select one of the lists and press the **OK** button to add the current channel to the selected favorite list.



In Live TV mode, press the Left directional button to display the TV channel lists broadcast sources and favorite lists. Optionally select ATV, Cable, Antenna or Satellite to display available stored TV channels. In the general list, favorite channels will be marked with a heart symbol.

If you only want to display the channels added to one of your favorite lists, select one you have already created.

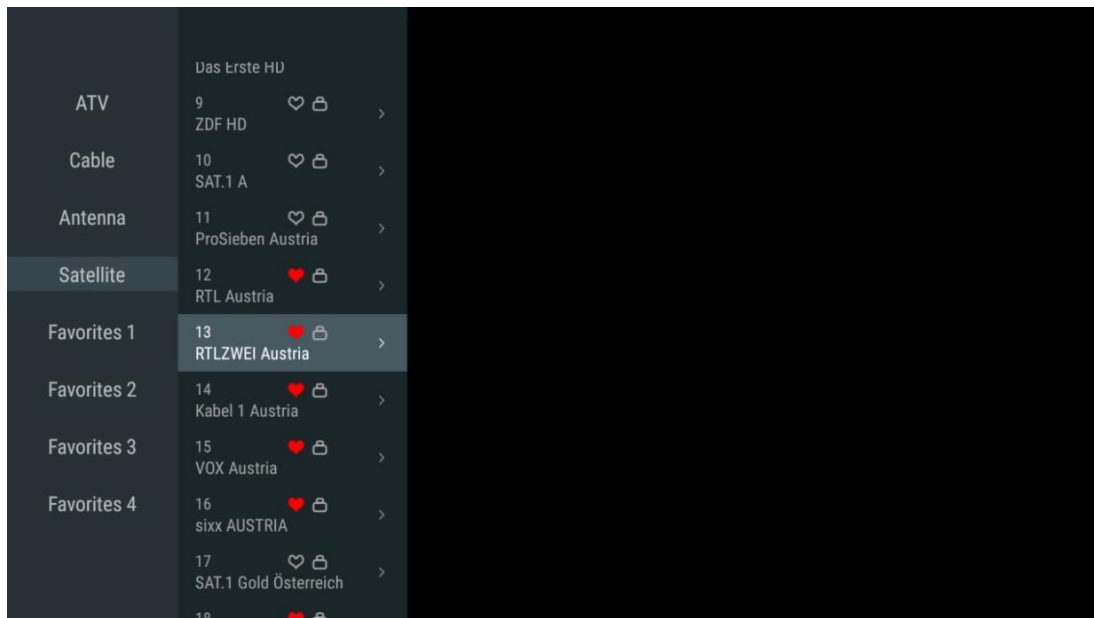

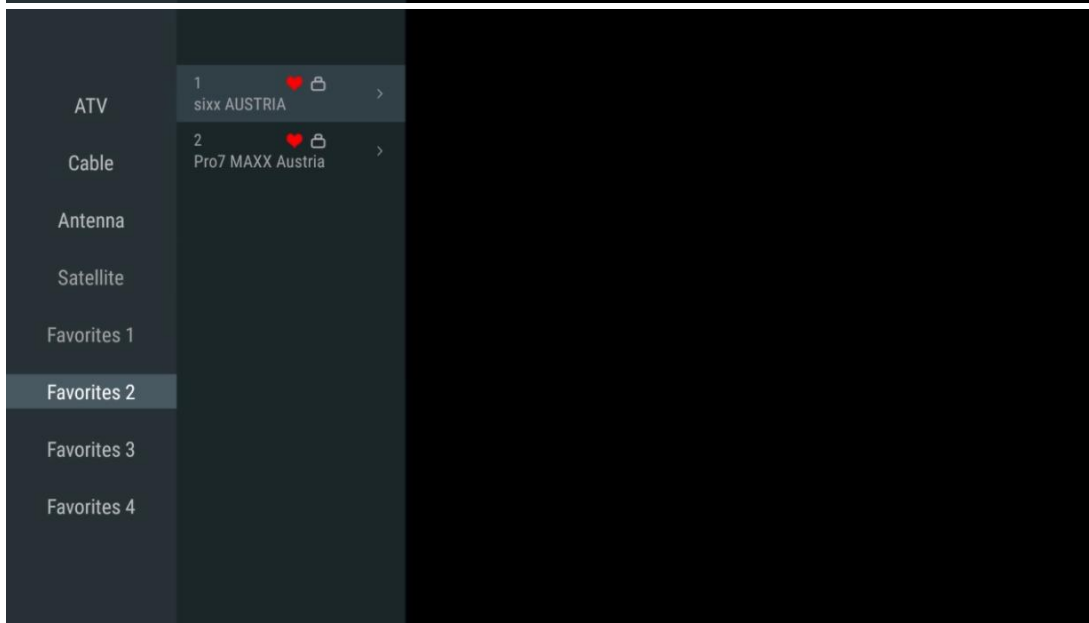
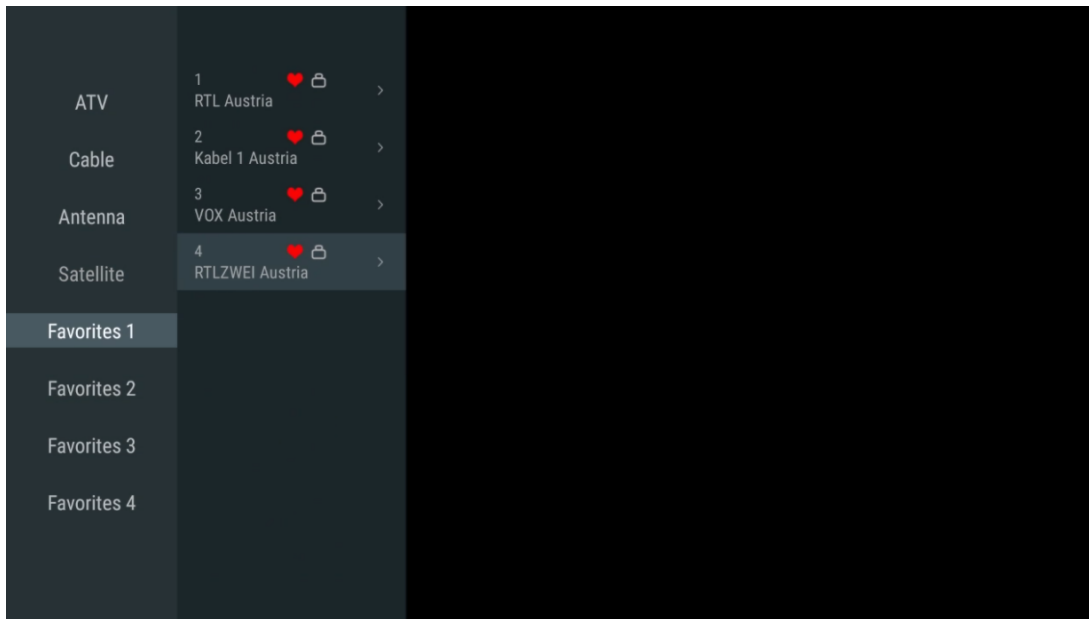

### 11.2.3 Remove Favorite

Remove the current TV channel from one or all of your favorite lists.

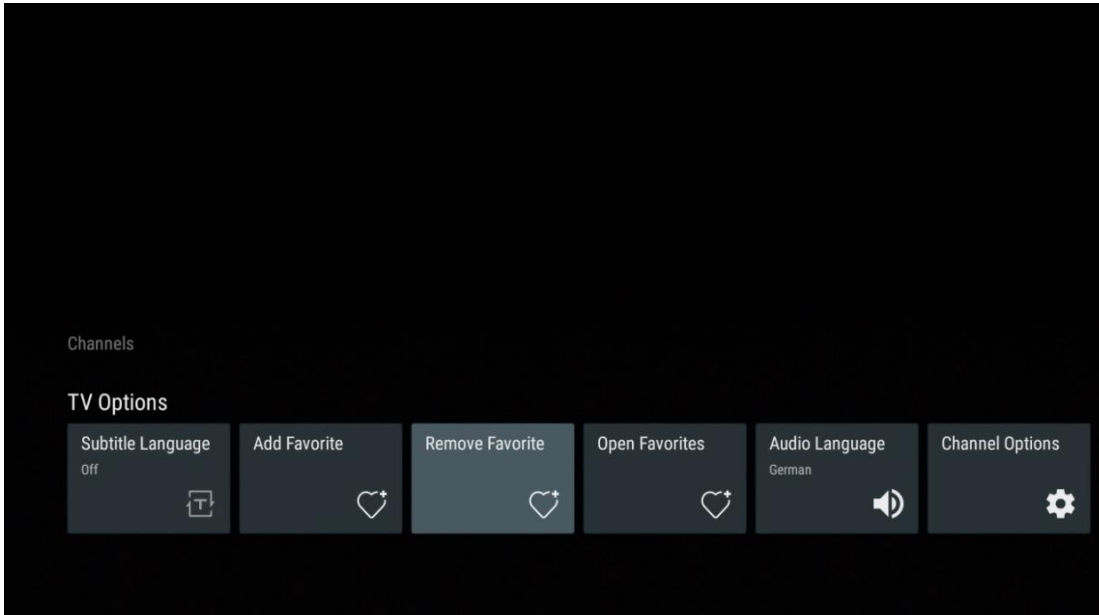



# 11.2.4 Open Favorites

Display the created favorite lists.

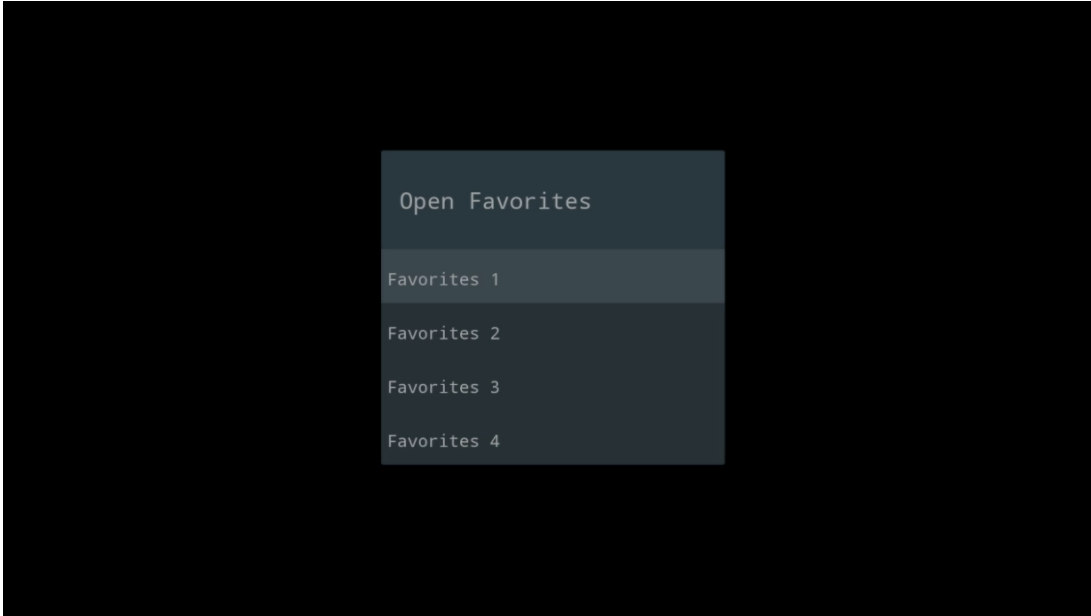
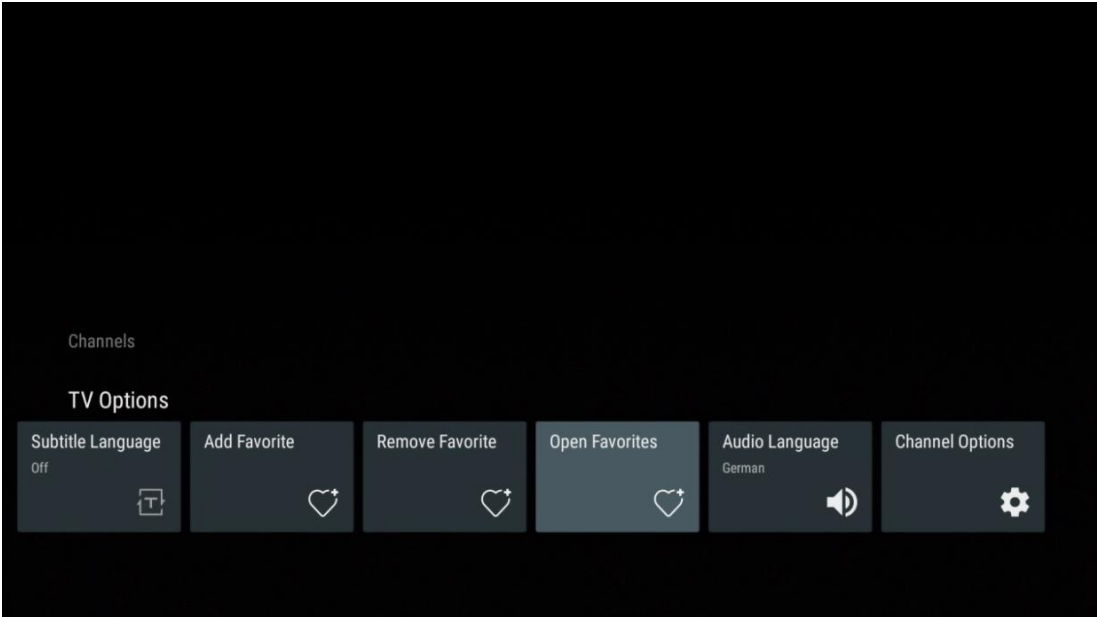

## 11.2.5 Audio Language

Some TV channels offer multiple audio languages. Select your preferred audio language in this menu.

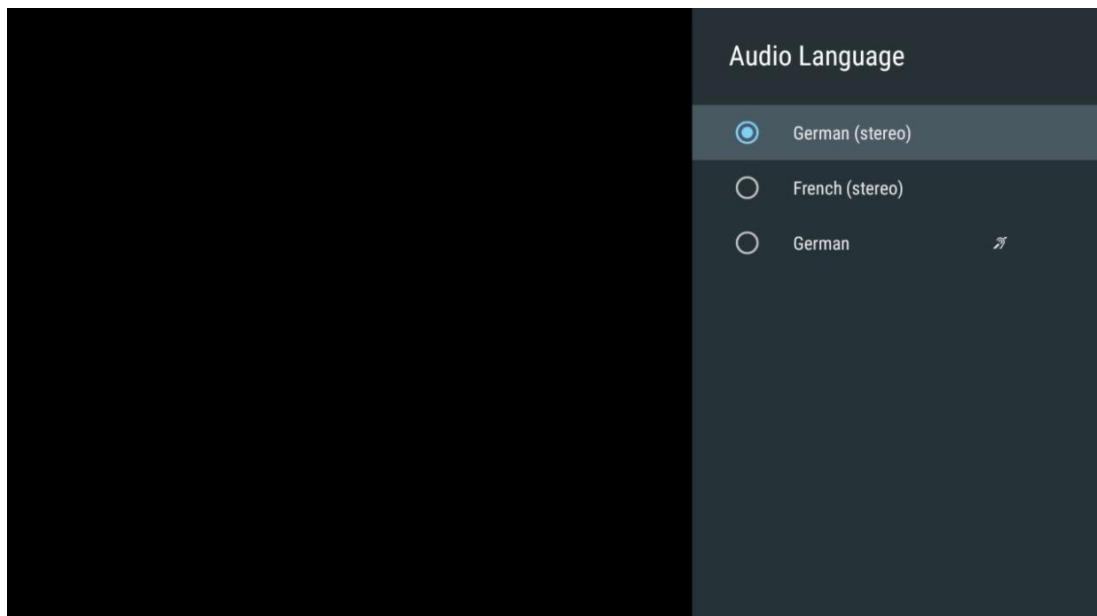
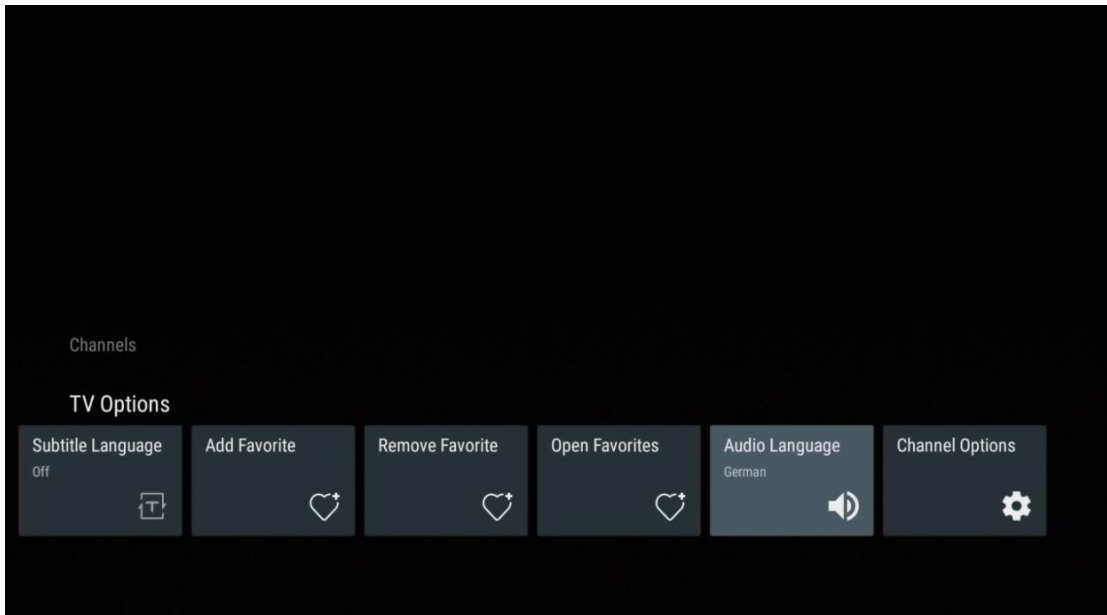

## 11.2.6 Channel Options

### 11.2.6.1 Customize channel list

Select channels from the list that you do not want to have displayed in the channel list. For this use the right directional button on your remote control.

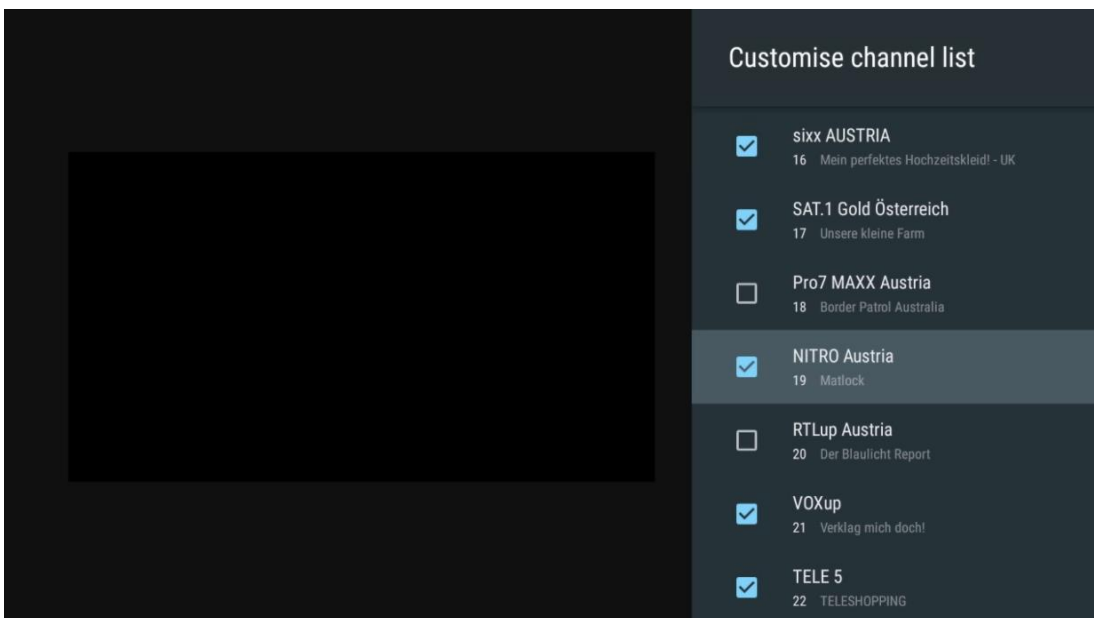
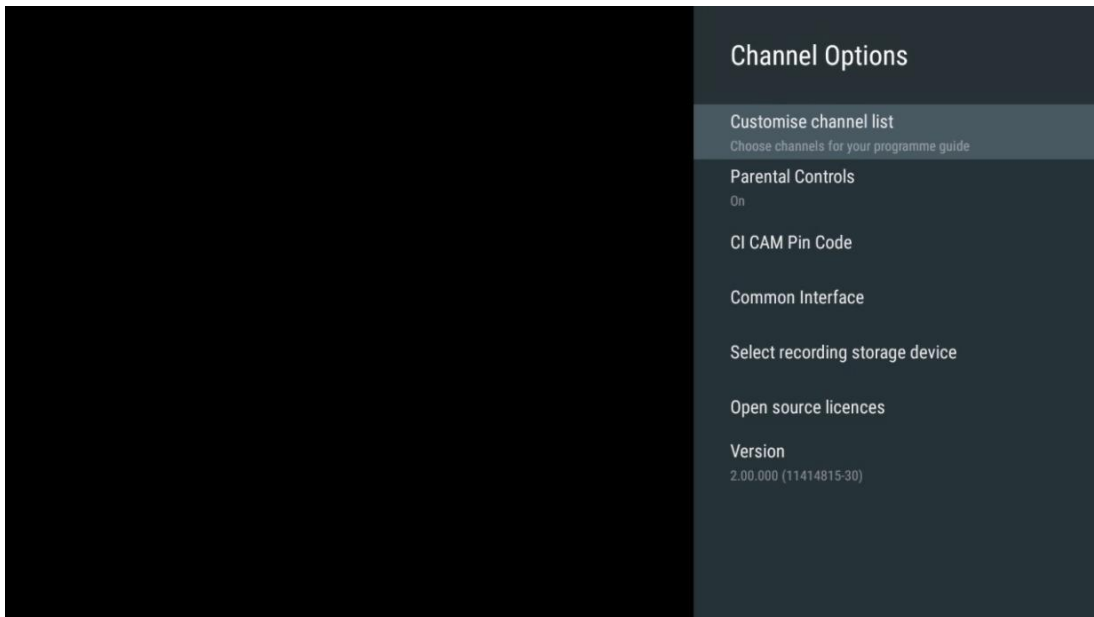

### 11.2.6.2 Parental Controls

Set various parental control options. To access them, you'll need to enter the PIN code you set after opening the Live TV app for the first time.

- **Enabled / Disabled:** Enable or disable the parental control function.
- **Source Lock:** Lock TV broadcast sources or external input sources.
- **Channels blocked:** Block certain TV broadcast channels.
- **Ratings:** Define and set different rating limits.
- **Change PIN:** Manage your PIN code.

### 11.2.6.3 CI CAM Pin Code

Activate or deactivate the CI CAM PIN code entering function if available or required for the connected CI CAM module.

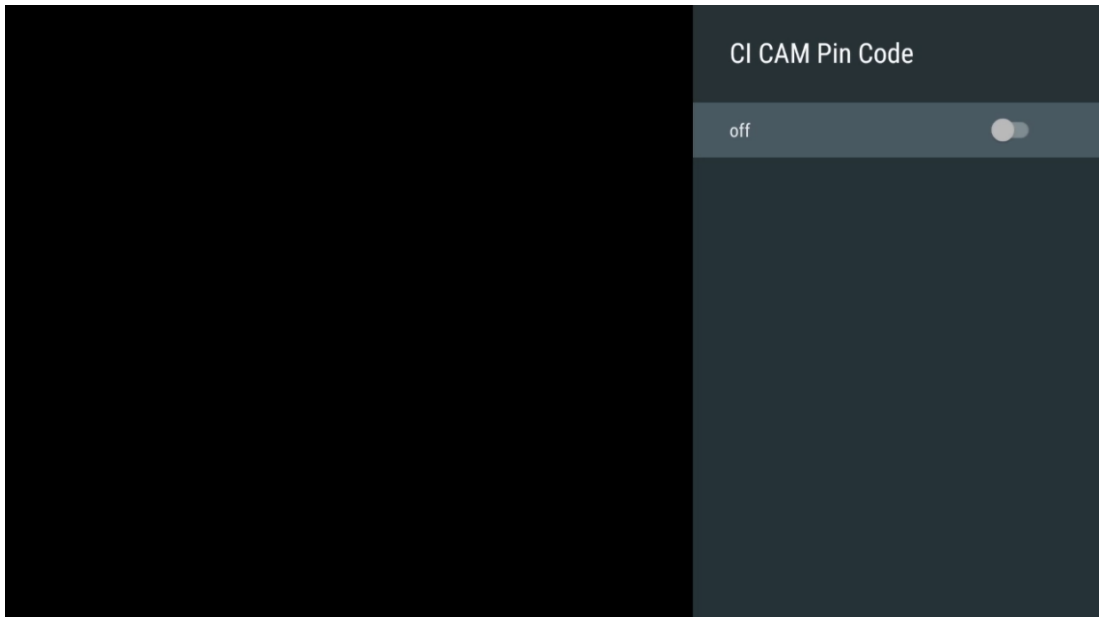

### 11.2.6.4 Common Interface

Access the connected CI module Menu by pressing the **OK** button.

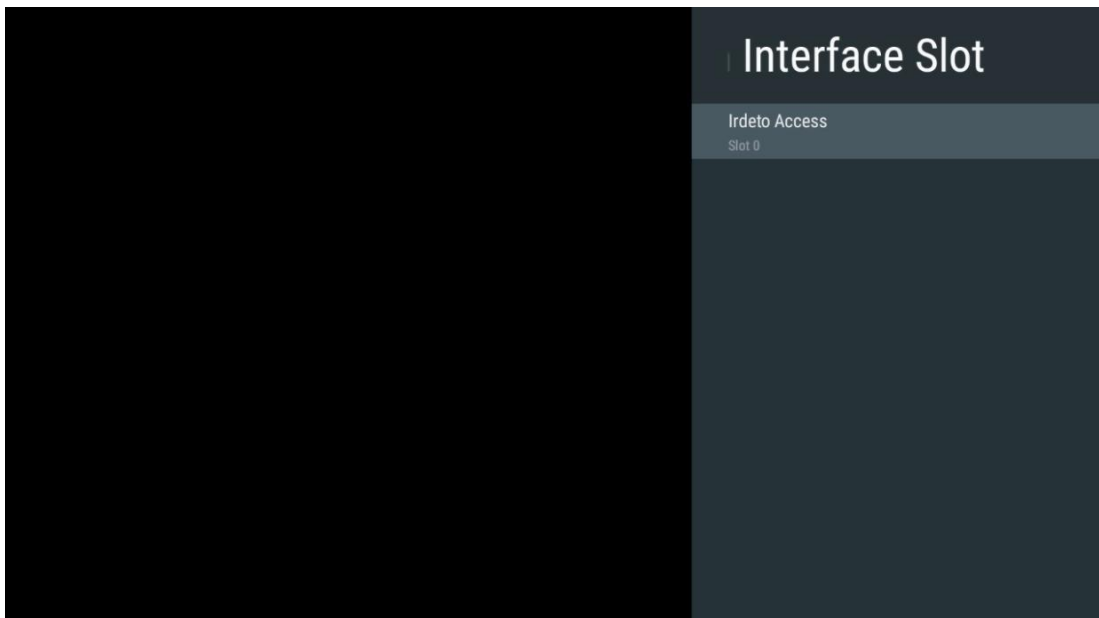

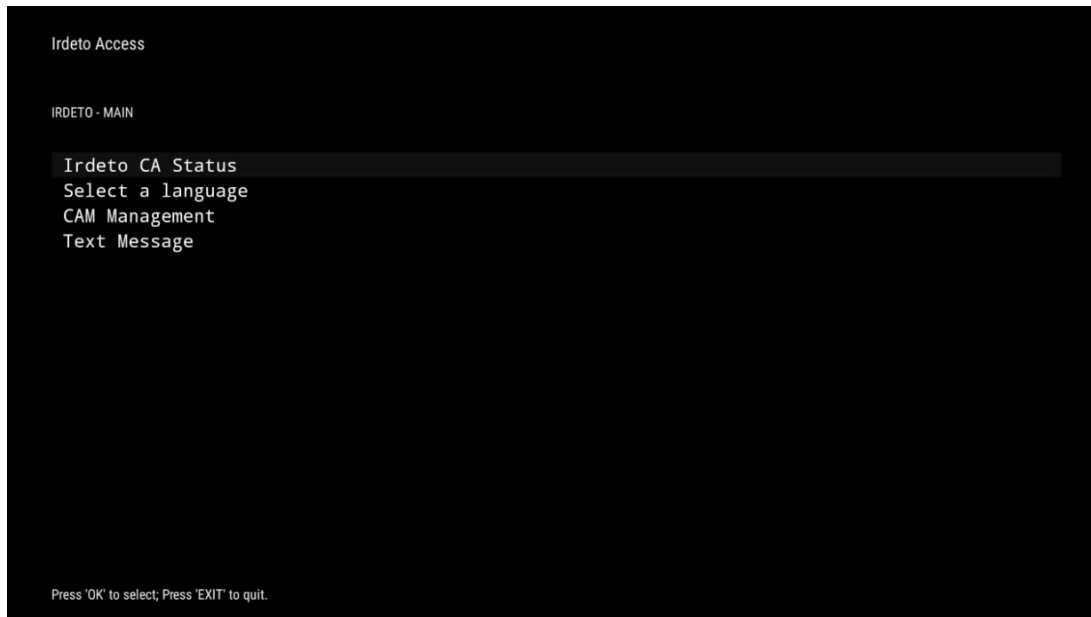

### 11.2.6.5 Open-source licenses

View information about open-source licenses.

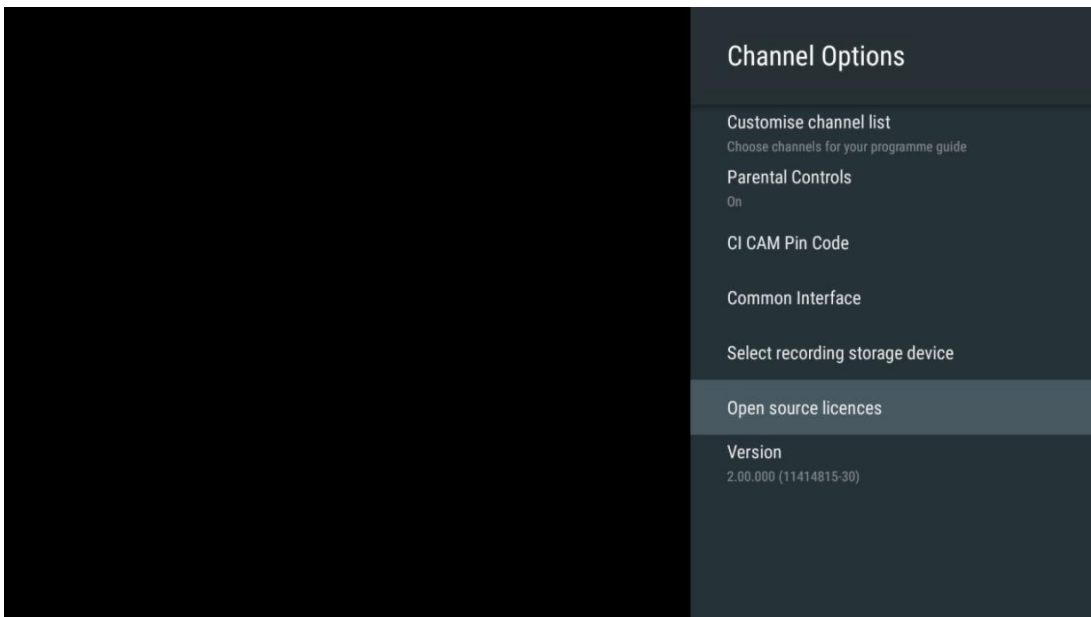

### 11.2.6.6 Version

View the software version of the TV device.

## 12 Multimedia Player App

If you want to play multimedia content such as movies, music or photos from external storage devices connected to the USB port, launch the multimedia player app from your Home screen.

**Note:** Connected USB storage devices, such as HDD/SDD or USB sticks have to be formatted in **FAT32 or NTFS**. Devices formatted in exFAT are not supported.

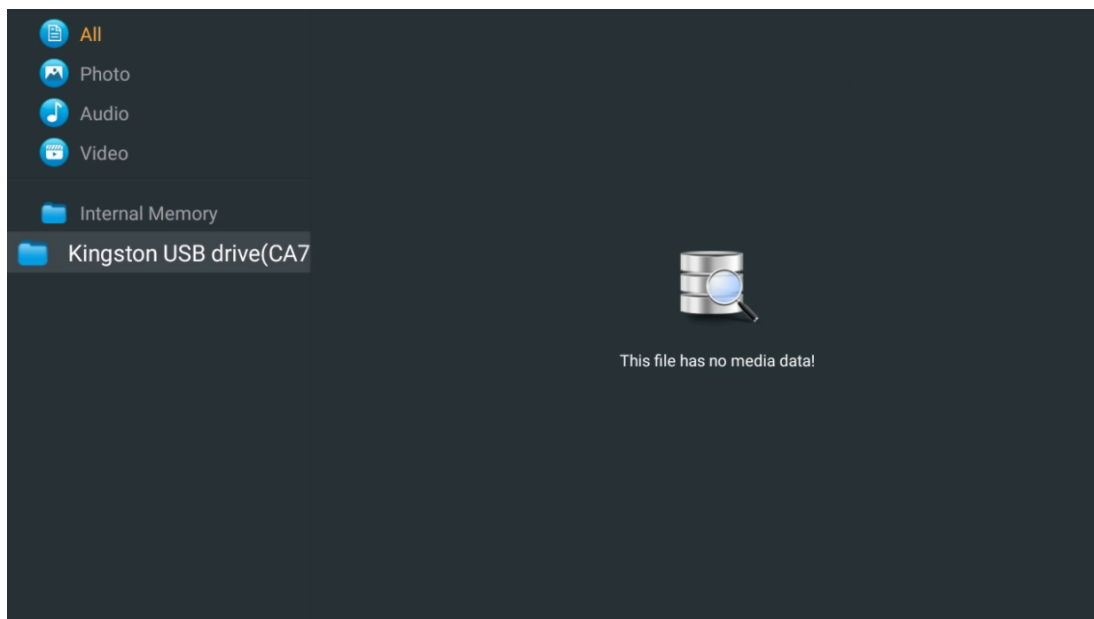

Select your USB storage device on the screen and press the **OK** button. The stored multimedia content will be displayed. Select the desired content and press **OK** to display it.

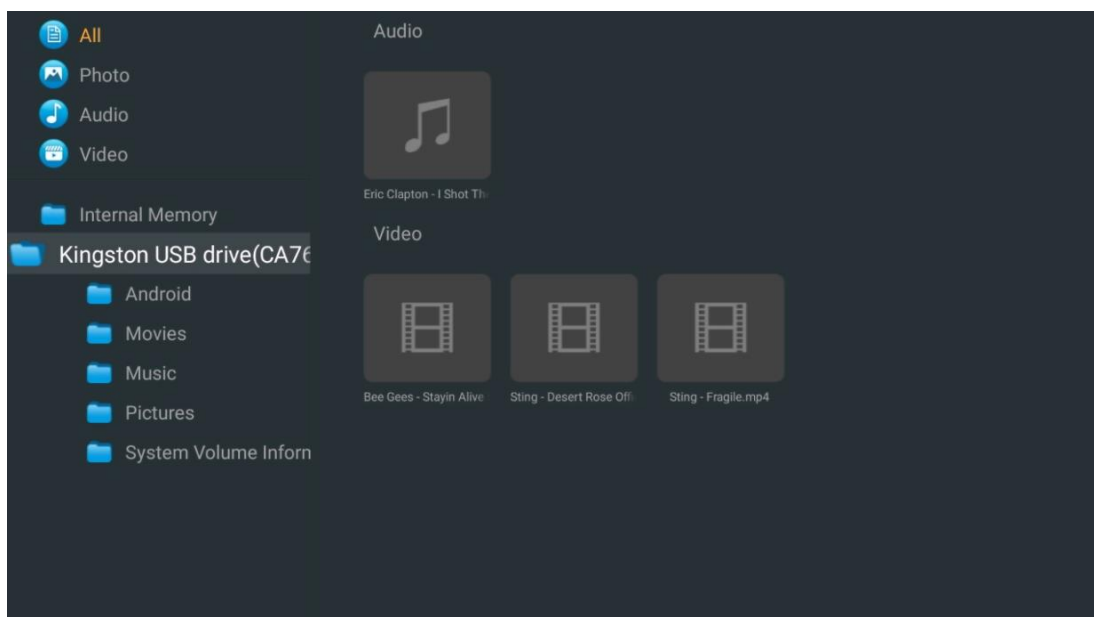

## 13 Troubleshooting

No power	Check if the AC power cord of your TV is plugged in or not. If there is still no power, please disconnect the plug and reconnect to the socket after 60 seconds. Turn the power back on.
No picture	Check if the antenna cable at the back is connected properly. View other channels to see if the problem still occurs.
Video appears with no audio	Try to increase the volume. Check if the TV's sound is on mute or not.
Remote doesn't work	Make sure the plastic bag which came with the remote control is removed. Try using the remote in a shorter distance from the TV. Check if the placement of the batteries is correct or try using new batteries with the remote control. The TV will go into Standby mode if it receives no response within a few minutes.
Problems are unresolved	Unplug the power cable and wait for 30 seconds, then reconnect power cable to the socket. If the problems still exist, do not attempt to repair the TV by yourself. Kindly contact the service center.
Dolby Atmos is not working with connected streaming devices	<ol style="list-style-type: none"> <li>1. Connect the Streaming Device <ul style="list-style-type: none"> <li>○ Plug your streaming device into one of the HDMI ports on your Thomson TV.</li> </ul> </li> <li>2. Ensure Proper Connection to AV Receiver/Amplifier <ul style="list-style-type: none"> <li>○ Confirm that your AV Receiver / Amplifier supports Dolby Atmos.</li> <li>○ Connect your Thomson TV using the HDMI eARC port to the HDMI In port on your AV Receiver / Amplifier.</li> </ul> </li> <li>3. Verify Dolby Atmos Availability <ul style="list-style-type: none"> <li>○ When you play a video, check the video description for audio playback options.</li> <li>○ Dolby Atmos will be listed as an option if the connections are properly set up and the AV receiver/amplifier supports it.</li> </ul> </li> </ol>

# 14 Technical specifications

## Thomson Google TV UHD Side Feet

	43UG4S14	50UG4S14	55UG4S14	65UG4S14
Operating Voltage	AC 100-240V 50/60Hz	AC 100-240V 50/60Hz	AC 100-240V 50/60Hz	AC 100-240V 50/60Hz
Audio Output Power	2 x 8	2 x 10	2 x 10	2 x 10
Power Consumption (W)	90	100	110	200
Networked Standby Power Consumption (W)	0,5	0,5	0,5	0,5
Weight (kg)	6	8,58	11,48	17,02
TV Dimensions LxWxH (with stand) (mm)	957x172x591	1111x260x692	1226x260x745	1446x290x869
TV Dimensions LxWxH (without stand) (mm)	957x85x556	1111x77x643	1226x78x712	1446x79x834
Display	43" / 109 cm	50" / 126 cm	55" / 139 cm	65" / 164 cm
Screen resolution	3840 x 2160	3840 x 2160	3840 x 2160	3840 x 2160

## Thomson Google TV UHD Side Feet White

	43UG4S14W	50UG4S14W	55UG4S14W
Operating Voltage	AC 100-240V 50/60Hz	AC 100-240V 50/60Hz	AC 100-240V 50/60Hz
Audio Output Power	2 x 8	2 x 10	2 x 10
Power Consumption (W)	90	100	110
Networked Standby Power Consumption (W)	0,5	0,5	0,5
Weight (kg)	6	8,58	11,48
TV Dimensions LxWxH (with stand) (mm)	957x172x591	1111x260x692	1226x290x745
TV Dimensions LxWxH (without stand) (mm)	957x85x556	1111x77x643	1226x78x712
Display	43" / 109 cm	50" / 126 cm	55" / 139 cm
Screen resolution	3840 x 2160	3840 x 2160	3840 x 2160

## Thomson Google TV UHD Central Stand

	43UG5C14	50UG5C14	55UG5C14	65UG5C14	75UG5C14
Operating Voltage	AC 100-240V 50/60Hz	AC 100-240V 50/60Hz	AC 100-240V 50/60Hz	AC 100-240V 50/60Hz	AC 100-240V 50/60Hz
Audio Output Power	2 x 8	2 x 10	2 x 10	2 x 10	2 x 10
Power Consumption (W)	100	120	140	200	240
Networked Standby Power Consumption (W)	0,5	0,5	0,5	0,5	0,5
Weight (kg)	10	13	14,7	19,5	24
TV Dimensions LxWxH (with stand) (mm)	957x281x587	1111x281x676	1226x281x744	1446x281x869	1668x281x990
TV Dimensions LxWxH (without stand) (mm)	957x89x556	1111x75x643	1226x78x712	1446x79x834	1668x89x956
Display	43" / 109 cm	50" / 126 cm	55" / 139 cm	65" / 164 cm	75" / 189 cm
Screen resolution	3840 x 2160	3840 x 2160	3840 x 2160	3840 x 2160	3840 x 2160

## Thomson Google TV QLED Side Feet

	43QG4S14	50QG4S14	55QG4S14	65QG4S14	85QG5S14
Operating Voltage	AC 100-240V 50/60Hz	AC 100-240V 50/60Hz	AC 100-240V 50/60Hz	AC 100-240V 50/60Hz	AC 100-240V 50/60Hz
Audio Output Power	2 x 8	2 x 10	2 x 10	2 x 10	2 x 10



Power Consumption (W)	100	120	140	200	300
Networked Standby Power Consumption (W)	0,5	0,5	0,5	0,5	0,5
Weight (kg)	7,9	10,9	12,6	17,1	29,8
TV Dimensions LxWxH (with stand) (mm)	957x270x605	1111x270x677	1226x290x745	1446x290x869	1890x360x1115
TV Dimensions LxWxH (without stand) (mm)	957x89x556	1111x75x643	1226x78x712	1446x79x834	1890x95x1082
Display	43" / 109 cm	50" / 126 cm	55" / 139 cm	65" / 164 cm	85" / 215 cm
Screen resolution	3840 x 2160	3840 x 2160	3840 x 2160	3840 x 2160	3840 x 2160

### Thomson Google TV QLED Central Stand

	43QG5C14	50QG5C14	55QG5C14	65QG5C14	75QG5C14
Operating Voltage	AC 100-240V 50/60Hz	AC 100-240V 50/60Hz	AC 100-240V 50/60Hz	AC 100-240V 50/60Hz	AC 100-240V 50/60Hz
Audio Output Power	2 x 8	2 x 10	2 x 10	2 x 10	2 x 10
Power Consumption (W)	100	120	140	200	240
Networked Standby Power Consumption (W)	0,5	0,5	0,5	0,5	0,5
Weight (kg)	10	13	14,7	19,5	23,6
TV Dimensions LxWxH (with stand) (mm)	957x281x587	1111x281x677	1227x281x744	1446x281x869	1668x281x990
TV Dimensions LxWxH (without stand) (mm)	957x89x556	1111x75x643	1226x78x712	1446x79x834	1668x89x956
Display	43" / 109 cm	50" / 126 cm	55" / 139 cm	65" / 164 cm	75" / 190 cm
Screen resolution	3840 x 2160	3840 x 2160	3840 x 2160	3840 x 2160	3840 x 2160

### Thomson Google TV QLED Plus

	43QG6C14	50QG6C14	55QG6C14	65QG6C14
Operating Voltage	AC 100-240V 50/60Hz	AC 100-240V 50/60Hz	AC 100-240V 50/60Hz	AC 100-240V 50/60Hz
Audio Output Power	2 x 8	2 x 10	2 x 10	2 x 10
Power Consumption (W)	100	120	140	200
Networked Standby Power Consumption (W)	0,5	0,5	0,5	0,5
Weight (kg)	10,8	14	15,8	21,3
TV Dimensions LxWxH (with stand) (mm)	957x281x619	1111x281x712	1226x281x776	1446x281x904
TV Dimensions LxWxH (without stand) (mm)	957x88x589	1111x75x676	1226x77x745	1446x78x867
Display	43" / 109 cm	50" / 126 cm	55" / 139 cm	65" / 164
Screen resolution	3840 x 2160	3840 x 2160	3840 x 2160	3840 x 2160

### Thomson Google TV QLED Pro

	43QG7C14/ 43QG7C04	50QG7C14/ 50QG7C04	55QG7C14/ 55QG7C04	65QG7C14/ 65QG7C04	75QG7C14
Operating Voltage	AC 100-240V 50/60Hz	AC 100-240V 50/60Hz	AC 100-240V 50/60Hz	AC 100-240V 50/60Hz	AC 100-240V 50/60Hz
Audio Output Power	2 x 8	2 x 10	2 x 10	2 x 10	2 x 10
Power Consumption (W)	120	140	170	200	240
Networked Standby Power Consumption (W)	0,5	0,5	0,5	0,5	0,5
Weight (kg)	10	13	14,7	19,5	24

TV Dimensions LxWxH (with stand) (mm)	957x89x556	1111x75x643	1227x78x712	1446x79x834	1668x89x956
TV Dimensions LxWxH (without stand) (mm)	957x281x587	1111x281x676	1227x281x744	1446x281x869	1668x281x990
Display	43" / 109 cm	50" / 126 cm	55" / 139 cm	65" / 164 cm	75" / 189 cm
Screen resolution	3840 x 2160	3840 x 2160	3840 x 2160	3840 x 2160	3840 x 2160

	<b>85QG7S14</b>	<b>100QG7S14</b>
Operating Voltage	AC 100-240V 50/60Hz	AC 100-240V 50/60Hz
Audio Output Power	2 x 12	2 x 12
Power Consumption (W)	300	500
Networked Standby Power Consumption (W)	0,5	0,5
Weight (kg)	29,8	46,42
TV Dimensions LxWxH (with stand) (mm)	1890x95x1082	2227x89x1271
TV Dimensions LxWxH (without stand) (mm)	1890x360x1115	2227x389x1321
Display	85" / 215 cm	100" / 223,5 cm
Screen resolution	3840 x 2160	3840 x 2160

## 14.1 Country restrictions

Intended for indoor use only.

AT	BE	BG	CH	CY	CZ	DE	DK	EE	ES	FI	FR
GR	HR	HU	IE	IS	IT	LI	LT	LU	LV	MT	NL
NO	PL	PT	RO	SI	SK	SE	TR	UK	(NI)		

## 14.2 Licenses

Subject to alterations. In consequence of continuous research and development technical specifications, design and appearance of products may change. Google TV is the name of this device's software experience and a trademark of Google LLC. Google, YouTube, Google Cast and YouTube Music are trademarks of Google LLC. Google Assistant is not available in certain languages and countries. Availability of services varies by country and language. Netflix is a registered trademark of Netflix, Inc. Netflix streaming membership required. 4K Ultra HD availability subject to your subscription plan, Internet service, device capabilities, and content availability. [www.netflix.com/TermsOfUse](http://www.netflix.com/TermsOfUse). Apple TV is a trademark of Apple Inc., registered in the U.S. and other countries and regions. Wi-Fi is a registered trademark of Wi-Fi Alliance®. The terms HDMI and HDMI High-Definition Multimedia Interface, and the HDMI logo are trademarks or registered marks of HDMI Licensing Administrator, Inc. in the United States and other countries. Dolby, Dolby Vision, Dolby Atmos, Dolby Audio, and the double-D symbol are trademarks of Dolby Laboratories Licensing Corporation. Manufactured under license from Dolby Laboratories. Confidential unpublished works. Copyright © 1992–2025 Dolby Laboratories. All other products, services, companies, trademarks, trade or product name and logos referenced herein are the property of their respective owners. All rights reserved. ©2025 StreamView GmbH, Franz-Josefs-Kai 1, 1010 Vienna, Austria. This product has been manufactured and sold under the responsibility of StreamView GmbH. THOMSON, and the THOMSON logo are trademarks used under license by StreamView GmbH – further information at [www.thomson-brand.com](http://www.thomson-brand.com).